



Operation **Manual**

Goodrive350 IP54 **High-ingress Protection** **Series VFD**



SHENZHEN INVT ELECTRIC CO., LTD.

No.	Change description	Version	Release date
1	Initial version	V1.0	Jan. 2019
2	<ol style="list-style-type: none"> 1. Update section 3.4 "Rated value" 2. Update EMC filters 3. Add 004G/5R5P–5R5G/7R5P VFD models 4. Update part of descriptions 	V1.1	May. 2019
3	<ol style="list-style-type: none"> 1. Add 030G/037P–055G/075P VFD models 2. Update part of function code descriptions 3. Update the terminal function description in section A.7 4. Add the application standards 5. Add the weight information of VFD dimensions 	V1.2	Nov. 2019
5	<ol style="list-style-type: none"> 1. Updated Perface content 2. Updated the description of derating due to altitude and the product specification table 3. Replaced the nameplate figure with a clear one 4. Added notes about the shared DC bus 5. Updated the description of HDO, Y1, Y2, and HDIB terminals 6. Updated the function codes descriptions 7. Updated the writing of proper nouns, such as "Modbus", "PROFITBUS" 8. Added two supported extension card models 9. Updated the voltage range of PW terminal to "12-30V" 10. Updated the indicator definition table of the UVW incremental PG card in A.7.1 11. Updated the application standard and deleted the year from the standard names 	V1.3	Nov. 2020

Preface

Thank you for choosing Goodrive350 IP54 high-ingress protection series VFD.

The Goodrive350 IP54 high-ingress protection series VFD is a high-performance and multipurpose VFD aiming to integrate the driving of synchronous motors and asynchronous motors, and torque control, speed control with position control. It is armed with advanced vector control technology and the latest digital processor dedicated for motor control, thus enhancing product reliability and adaptability to the environment. The Goodrive350 IP54 high-ingress protection series VFD adopts customized and industrialized design to realize excellent control performance through optimized functions and flexible applications.

To meet the basic needs of customers, VFDs of power range from 4 to 110 kW are planned to be developed for Goodrive350 IP54 high-ingress protection series VFDs. At present, VFDs of power range from 4 to 55 kW have been put into use, and VFDs of other power ranges are being developed. To meet diversified customer demands, the Goodrive350 IP54 high-ingress protection series VFD provides abundant extension cards including programmable extension card, PG card, communication card and I/O extension card to achieve various functions as needed.

The programmable extension card adopts mainstream development environment for customers to carry out secondary development easily, fulfilling varied customized needs and reducing customer cost.

PG card supports a variety of encoders like incremental encoders and resolver-type encoders, in addition, it also supports pulse reference and frequency-division output. PG card adopts digital filter technology to improve EMC performance and to realize stable transmission of the encoder signal over a long distance. It is equipped with encoder offline detection function to contain the impact of system faults.

The Goodrive350 IP54 high-ingress protection series VFD supports multiple kinds of popular communication modes to realize complicated system solutions. It can be connected to the internet with optional wireless communication card, by which users can monitor the VFD state anywhere any time via mobile APP.

The Goodrive350 IP54 high-ingress protection series VFD uses high power density design. Some power ranges carry built-in DC reactor and brake unit to save installation space. Through overall EMC design, it can satisfy the low noise and low electromagnetic interference requirements to cope with challenging grid, temperature, humidity and dust conditions, thus greatly improving product reliability.

This operation manual presents installation wiring, parameter setup, fault diagnosis and trouble shooting, and precautions related to daily maintenance. Read through this manual carefully before installation to ensure that the Goodrive350 IP54 high-ingress protection series VFD is installed and operated in a proper manner to give full play to its excellent performance and powerful functions.

If the end user is a military unit or the product is used for weapon manufacturing, please comply with relevant export control regulations in the Foreign Trade Law of the People's Republic of China, and complete necessary formalities. Our company reserves the right to update the information of our products.

Contents

Preface	i
Contents	ii
1 Safety precautions	1
1.1 What this chapter contains	1
1.2 Safety definition	1
1.3 Warning symbols.....	1
1.4 Safety guidelines.....	2
1.4.1 Delivery and installation.....	2
1.4.2 Commissioning and running	3
1.4.3 Maintenance and component replacement.....	4
1.4.4 Scrap treatment.....	4
2 Precautions for quick application	5
2.1 What this chapter contains	5
2.2 Unpack inspection.....	5
2.3 Application confirmation	5
2.4 Environment confirmation.....	5
2.5 Installation confirmation.....	6
2.6 Basic commissioning.....	7
3 Product overview	8
3.1 What this chapter contains	8
3.2 Basic principle.....	8
3.3 Product specification	9
3.4 Product nameplate	11
3.5 Model code	11
3.6 Rated values	12
3.7 Structure diagram	13
4 Installation guide	14
4.1 What this chapter contains	14
4.2 Mechanical installation	14
4.2.1 Installation environment.....	14
4.2.2 Installation direction.....	15
4.2.3 Installation mode	16
4.2.4 Single-unit installation.....	16
4.2.5 Multiple-unit installation	17
4.2.6 Vertical installation.....	18
4.2.7 Tilted installation.....	19
4.3 Standard wiring of main circuit.....	20
4.3.1 Wiring diagram of main circuit.....	20

4.3.2 Main circuit terminal diagram	20
4.3.3 Wiring process of the main circuit terminals	22
4.4 Standard wiring of control circuit.....	23
4.4.1 Wiring diagram of basic control circuit.....	23
4.4.2 Input/output signal connection diagram	25
4.5 Wiring protection	26
4.5.1 Protect the VFD and input power cable in short-circuit	26
4.5.2 Protect the motor and motor cable in short circuit.....	27
4.5.3 Protect motor and prevent thermal overload.....	27
4.5.4 Bypass connection	27
5 Basic operation instructions	28
5.1 What this chapter contains	28
5.2 Keypad introduction	28
5.3 Keypad display.....	32
5.3.1 Stop parameter display state	32
5.3.2 Running parameter display state	32
5.3.3 Fault alarm display state.....	33
5.4 Keypad operation.....	34
5.4.1 Enter/exit menu	34
5.4.2 List edit.....	39
5.4.3 Add parameters to the parameter list displayed in stop/running state	40
5.4.4 Add parameter to common parameter setup list	41
5.4.5 Parameter selection edit interface.....	41
5.4.6 Parameter setup edit interface	42
5.4.7 State monitoring interface	42
5.4.8 Motor parameter autotuning.....	43
5.4.9 Parameter backup	43
5.4.10 System setup.....	44
5.4.11 Power-on guiding settings.....	44
5.5 Basic operation instruction	47
5.5.1 What this section contains	47
5.5.2 Common commissioning procedures	48
5.5.3 Vector control	51
5.5.4 SVPWM control mode	56
5.5.5 Torque control.....	62
5.5.6 Motor parameter	66
5.5.7 Start/stop control	72
5.5.8 Frequency setup.....	78
5.5.9 Analog input	82
5.5.10 Analog output	85

5.5.11 Digital input.....	89
5.5.12 Digital output	97
5.5.13 Simple PLC	101
5.5.14 Multi-step speed running.....	104
5.5.15 PID control	106
5.5.16 Run at wobbling frequency	111
5.5.17 Local encoder input	113
5.5.18 Commissioning procedures for closed-loop control, position control and spindle positioning.....	114
5.5.19 Fault handling.....	120
6 Function parameter list.....	125
6.1 What this chapter contains	125
6.2 Function parameter list.....	125
P00—Basic functions.....	126
P01—Start/stop control.....	130
P02—Parameters of motor 1.....	136
P03—Vector control of motor 1	140
P04—V/F control	147
P05—Input terminals	154
P06—Output terminals.....	163
P07—HMI.....	167
P08—Enhanced functions.....	173
P09—PID control.....	180
P10—Simple PLC and multi-step speed control	185
P11—Protection parameters	188
P12—Parameters of motor 2.....	194
P13—Control parameters of synchronous motor	197
P14—Serial communication function.....	199
P15—Functions of communication extension card 1	201
P16—Functions of communication extension card 2	202
P17—State-check functions	202
P18—Closed-loop control state check.....	207
P19—Extension card state check.....	210
P20—Encoder of motor 1.....	211
P21—Position control	215
P22—Spindle positioning.....	220
P23—Vector control of motor 2	223
P24—Encoder of motor 2.....	225
P25—Extension I/O card input functions	229
P26—Output functions of extension I/O card.....	232

P28—Master/slave control functions	235
P90—Customized function group 1	236
P91—Customized function group 2	236
P92—Customized function group 3	237
P93—Customized function group 4	237
7 Troubleshooting.....	238
7.1 What this chapter contains	238
7.2 Indications of alarms and faults	238
7.3 Fault reset.....	238
7.4 Fault history	238
7.5 VFD faults and solutions	238
7.5.1 Details of faults and solutions	238
7.5.2 Other state	246
7.6 Analysis on common faults.....	247
7.6.1 Motor fails to work	247
7.6.2 Motor vibrates.....	248
7.6.3 Overvoltage.....	249
7.6.4 Undervoltage.....	249
7.6.5 Unusual heating of motor.....	250
7.6.6 VFD overheating	251
7.6.7 Motor stalls during ACC	252
7.6.8 Overcurrent	253
7.7 Countermeasures on common interference	254
7.7.1 Interference on meter switches and sensors	254
7.7.2 Interference on communication.....	255
7.7.3 Failure to stop and indicator shimmering due to motor cable coupling.....	256
7.7.4 Leakage current and interference on RCD	256
7.7.5 Live device chassis.....	257
8 Routine maintenance.....	258
8.1 What this chapter contains	258
8.2 Periodical inspection	258
8.3 Cooling fan.....	260
8.4 Capacitor	261
8.4.1 Capacitor reforming	261
8.4.2 Electrolytic capacitor replacement.....	262
8.5 Power cable	263
9 Communication protocol.....	264
9.1 What this chapter contains	264
9.2 Modbus protocol introduction	264
9.3 Application of Modbus	264

9.3.1 RS485.....	264
9.3.2 RTU mode.....	267
9.4 RTU command code and communication data.....	270
9.4.1 Command code: 03H, reading N words	270
9.4.2 Command code: 06H, writing a word	272
9.4.3 Command code: 08H, diagnosis	273
9.4.4 Command code: 10H, continuous writing	274
9.4.5 Data address definition	274
9.4.6 Fieldbus scale	279
9.4.7 Error message response	280
9.4.8 Read/Write operation example.....	281
9.5 Common communication faults	286
Appendix A Extension cards	287
A.1 Model definition	287
A.2 Dimensions and installation	293
A.3 Wiring.....	296
A.4 I/O extension card (EC-IO501-00) function description.....	296
A.5 Programmable extension card (EC-PC501-00) function description.....	298
A.6 Communication card function description.....	301
A.6.1 Bluetooth communication card	301
A.6.2 PROFIBUS-DP communication card	303
A.6.3 Ethernet communication card.....	305
A.6.4 CANopen communication card.....	305
A.6.5 PROFINET communication card.....	307
A.7 PG extension card function description	309
A.7.1 UVW incremental PG card—EC-PG503-05.....	309
A.7.2 Resolver PG card—EC-PG504-00	311
A.7.3 Multi-function incremental PG card—EC-PG505-12	313
Appendix B Technical data.....	318
B.1 What this chapter contains.....	318
B.2 Derated application.....	318
B.2.1 Capacity.....	318
B.2.2 Derating.....	318
B.3 Grid specifications	319
B.4 Motor connection data	319
B.4.1 EMC compatibility and motor cable length	319
B.5 Application standards.....	320
B.5.1 CE marking	320
B.5.2 EMC compliance declaration.....	320
B.6 EMC regulations	320

B.6.1 VFD category of C2.....	321
B.6.2 VFD category of C3.....	321
Appendix C Dimension drawings.....	322
C.1 What this chapter contains.....	322
C.2 VFD structure.....	322
C.3 Dimensions of VFDs.....	323
C.3.1 Wall-mounting dimensions	323
C.3.2 Flange installation dimensions	325
Appendix D Optional peripheral accessories.....	327
D.1 What this chapter contains.....	327
D.2 Wiring of peripheral accessories	327
D.3 Power supply.....	329
D.4 Cables.....	329
D.4.1 Power cables	329
D.4.2 Control cables.....	330
D.4.3 Cable arrangement	331
D.4.4 Insulation inspection	332
D.5 Breaker and electromagnetic contactor.....	332
D.6 Reactors.....	333
D.7 Filters	334
D.7.1 Filter model description.....	335
D.8 Brake system	336
D.8.1 Brake component selection	336
D.8.2 Brake resistor cable selection.....	338
D.8.3 Brake resistor installation	338
Appendix E STO function description	340
E.1 STO function logic table.....	340
E.2 STO channel delay description	341
E.3 STO function installation checklist.....	341
Appendix F Further information.....	342
F.1 Product and service queries	342
F.2 Feedback on INVT VFD manuals	342
F.3 Documents on the Internet	342

1 Safety precautions

1.1 What this chapter contains

Read this manual carefully and follow all safety precautions before moving, installing, operating and servicing the VFD. If these safety precautions are ignored, physical injury or death may occur, or damage may occur to the equipment.

If any physical injury or death or damage to the equipment occur due to neglect of the safety precautions in the manual, our company will not be responsible for any damages and we are not legally bound in any manner.

1.2 Safety definition

Danger: Serious physical injury or even death may occur if related requirements are not followed











Warning: Physical injury or damage to the equipment may occur if related requirements are not followed



Note: Procedures taken to ensure proper operation.

Qualified electricians: People working on the device should take part in professional electrical and safety training, receive the certification and be familiar with all steps and requirements of installing, commissioning, operating and maintaining the device to prevent any emergencies.





1.3 Warning symbols

Warnings caution you about conditions which can result in serious injury or death and/or damage to the equipment, and advice on how to avoid the danger. Following warning symbols are used in this manual.

Symbols	Name	Instruction	Abbreviation
 Danger	Danger	Serious physical injury or even death may occur if related requirements are not followed	
 Warning	Warning	Physical injury or damage to the equipment may occur if related requirements are not followed	
 Forbid	Electrostatic discharge	Damage to the PCBA board may occur if related requirements are not followed	
 Hot	Hot sides	The base of the VFD may become hot. Do not touch.	
 5 min	Electric shock	As high voltage still presents in the bus capacitor after power off, wait for at least five minutes (or 15 min / 25 min, depending on the warning symbols on the machine) after power off to prevent electric shock	 5 min

Symbols	Name	Instruction	Abbreviation
	Read manual	Read the operation manual before operating on the equipment	
Note	Note	Procedures taken to ensure proper operation	Note

1.4 Safety guidelines

	<ul style="list-style-type: none"> ◇ Only trained and qualified electricians are allowed to carry out related operations. ◇ Do not perform wiring, inspection or component replacement when power supply is applied. Ensure all the input power supplies are disconnected before wiring and inspection, and wait for at least the time designated on the VFD or until the DC bus voltage is less than 36V. The minimum waiting time is listed in the table below. <table border="1" style="margin-left: auto; margin-right: auto;"> <thead> <tr> <th colspan="2">VFD model</th> <th>Minimum waiting time</th> </tr> </thead> <tbody> <tr> <td style="text-align: center;">380V</td> <td style="text-align: center;">004G/5R5P-110G/132P</td> <td style="text-align: center;">5 min</td> </tr> </tbody> </table>	VFD model		Minimum waiting time	380V	004G/5R5P-110G/132P	5 min
VFD model		Minimum waiting time					
380V	004G/5R5P-110G/132P	5 min					
	<ul style="list-style-type: none"> ◇ Do not refit the VFD unless authorized; otherwise, fire, electric shock or other injuries may occur. 						
	<ul style="list-style-type: none"> ◇ The base of the radiator may become hot during running. Do not touch to avoid hurt. 						
	<ul style="list-style-type: none"> ◇ The electrical parts and components inside the VFD are electrostatic. Take measures to prevent electrostatic discharge during related operation. 						

1.4.1 Delivery and installation

	<ul style="list-style-type: none"> ◇ Install the VFD on fire-retardant material and keep the VFD away from combustible materials. ◇ Connect the optional brake parts (brake resistors, brake units or feedback units) according to the wiring diagram. ◇ Do not operate on a damaged or incomplete VFD. ◇ Do not touch the VFD with wet items or body parts; otherwise, electric shock may occur.
---	---

Note:

- ◇ Select appropriate tools for delivery and installation to ensure a safe and proper running of the VFD and avoid physical injury or death. To ensure physical safety, the installation staff should take mechanical protective measures like wearing exposure shoes and working uniforms;
- ◇ Ensure to avoid physical shock or vibration during delivery and installation;
- ◇ Do not carry the VFD by its front cover only as the cover may fall off;

- ◇ Installation site should be away from children and other public places;
- ◇ The VFD should be used in proper environment (see section 4.2.1 "Installation environment" for details);
- ◇ Prevent the screws, cables and other conductive parts from falling into the VFD;
- ◇ As leakage current of the VFD during running may exceed 3.5mA, ground properly and ensure the grounding resistance is less than 10Ω. The conductivity of PE grounding conductor is the same with that of the phase conductor. For models higher than 30 kW, the cross sectional area of the PE grounding conductor can be slightly less than the recommended area.
- ◇ R, S and T are the power input terminals, and U, V and W are output motor terminals. Connect the input power cables and motor cables properly; otherwise, damage to the VFD may occur.

1.4.2 Commissioning and running

	<ul style="list-style-type: none"> ◇ Disconnect all power sources applied to the VFD before terminal wiring, and wait for at least the time designated on the VFD after disconnecting the power sources. ◇ High voltage presents inside the VFD during running. Do not carry out any operation on the VFD during running except for keypad setup. ◇ The VFD may start up by itself when P01.21 (restart after power down) is set to 1. Do not get close to the VFD and motor. ◇ The VFD cannot be used as "Emergency-stop device". ◇ The VFD cannot act as an emergency brake for the motor; it is a must to install mechanical brake device. ◇ During driving permanent magnet synchronous motor, besides above-mentioned items, the following work must be done before installation and maintenance. <ol style="list-style-type: none"> 1. Disconnect all the input power sources including main power and control power. 2. Ensure the permanent-magnet synchronous motor has been stopped, and the voltage on output end of the VFD is lower than 36V. 3. After the permanent-magnet synchronous motor is stopped, wait for at least the time designated on the VFD, and ensure the voltage between "+" and "-" is lower than 36V. 4. During operation, it is a must to ensure the permanent-magnet synchronous motor cannot run again by the action of external load; it is recommended to install effective external brake device or disconnect the direct electrical connection between permanent-magnet synchronous motor and the VFD.
---	---

Note:

- ◇ Do not switch on or switch off input power sources of the VFD frequently;
- ◇ For VFDs that have been stored for a long time, set the capacitance and carry out inspection and pilot run on the VFD before use.
- ◇ Close the front cover before running; otherwise, electric shock may occur.



1.4.3 Maintenance and component replacement

	<ul style="list-style-type: none"> ✧ Only well-trained and qualified professionals are allowed to perform maintenance, inspection, and component replacement on the VFD. ✧ Disconnect all the power sources applied to the VFD before terminal wiring, and wait for at least the time designated on the VFD after disconnecting the power sources. ✧ Take measures to prevent screws, cables and other conductive matters from falling into the VFD during maintenance and component replacement.
---	--

Note:

- ✧ Use proper torque to tighten the screws.
- ✧ Keep the VFD and its parts and components away from combustible materials during maintenance and component replacement.
- ✧ Do not carry out insulation voltage-endurance test on the VFD, or measure the control circuits of the VFD with megameter.
- ✧ Take proper anti-static measures on the VFD and its internal parts during maintenance and component replacement.

1.4.4 Scrap treatment

	<ul style="list-style-type: none"> ✧ The heavy metals inside the VFD should be treated as industrial effluent.
	<ul style="list-style-type: none"> ✧ When the life cycle ends, the product should enter the recycling system. Dispose of it separately at an appropriate collection point instead of placing it in the normal waste stream.

2 Precautions for quick application

2.1 What this chapter contains

This chapter introduces the basic principles required during installation commissioning. Users can realize quick installation commissioning by following these principles.

2.2 Unpack inspection

Check as follows after receiving products.

1.	Check whether the packing box is damaged or dampened. If yes, contact local dealers or INVT offices.
2.	Check the model identifier on the exterior surface of the packing box is consistent with the purchased model. If no, contact local dealers or INVT offices.
3.	Check whether the interior surface of packing box is improper, for example, in wet condition, or whether the enclosure of the VFD is damaged or cracked. If yes, contact local dealers or INVT offices.
4.	Check whether the nameplate of the VFD is consistent with the model identifier on the exterior surface of the packing box. If not, contact local dealers or INVT offices.
5.	Check whether the accessories (including user's manual, control keypad and extension card units) inside the packing box are complete. If not, contact local dealers or INVT offices.

2.3 Application confirmation

Check the following items before operating on the VFD.

1.	Verify the load mechanical type to be driven by the VFD, and check whether overload occurred to the VFD during actual application, or whether the VFD power class needs to be enlarged?
2.	Check whether the actual running current of load motor is less than rated VFD current.
3.	Check whether the control precision required by actual load is the same with the control precision provided by the VFD.
4.	Check whether the grid voltage is consistent with rated VFD voltage.
5.	Check whether the functions required need an optional extension card to be realized.

2.4 Environment confirmation

Check the following items before use.

1.	Check whether the ambient temperature of the VFD during actual application exceeds 40°C, if yes, derate 1% for every additional 1°C. In addition, do not use the VFD when the ambient temperature exceeds 50°C.
Note: For cabinet-type VFD, its ambient temperature is the air temperature inside the cabinet.	

2. Check whether ambient temperature of the VFD during actual application is below -10°C, if yes, install heating facility. Note: For cabinet-type VFD, its ambient temperature is the air temperature inside the cabinet.
3. Check whether the altitude of the application site exceeds 1000m. If yes, derate 1% for every increase of 100m; when the installation site altitude exceeds 3000m, consult the local INVT dealer or office.
4. Check whether the humidity of application site exceeds 90%, if yes, check whether condensation occurred, if condensation does exist, take additional protective measures.
5. Check whether there is direct sunlight or animal intrusion in the application site, if yes, take additional protective measures.
6. Check whether there is dust, explosive or combustible gases in the application site, if yes, take additional protective measures.

2.5 Installation confirmation

After the VFD is installed properly, check the installation condition of the VFD.

1. Check whether the input power cable and current-carrying capacity of the motor cable fulfill actual load requirements.
2. Check whether peripheral accessories (including input reactors, input filters, output reactors, output filters, DC reactors, brake units and brake resistors) of the VFD are of correct type and installed properly; check whether the installation cables fulfill requirements on current-carrying capacity.
3. Check whether the VFD is installed on fire-retardant materials; check whether the hot parts (reactors, brake resistors, etc.) are kept away from combustible materials.
4. Check whether all the control cables are routed separately with power cables based on EMC requirement.
5. Check whether all the grounding systems are grounded properly according to VFD requirements.
6. Check whether installation spacing of the VFD complies with the requirements in operation manual.
7. Check whether installation mode of the VFD complies with the requirements in operation manual. Vertical installation should be adopted whenever possible.
8. Check whether external connecting terminals of the VFD are firm and tight enough, and whether the moment is up to the requirement.
9. Check whether there are redundant screws, cables or other conductive objects inside the VFD, if yes, take them out.

2.6 Basic commissioning

Carry out basic commissioning according to the following procedures before operating on the VFD.

- | |
|---|
| 1. Select motor type, set motor parameters and select VFD control mode according to actual motor parameters. |
| 2. Whether autotuning is needed? If possible, disconnect the motor load to carry out dynamic parameter autotuning; if the load cannot be disconnected, perform static autotuning. |
| 3. Adjust the acceleration and deceleration time based on actual working conditions of the load. |
| 4. Jogging to carry out device commissioning. Check whether the motor running direction is consistent with the direction required, if no, it is recommended to change the motor running direction by exchanging the motor wiring of any two phases. |
| 5. Set all the control parameters, and carry out actual operation. |

3 Product overview

3.1 What this chapter contains

This chapter mainly introduces the operation principles, product features, layouts, nameplates and model instructions.

3.2 Basic principle

The Goodrive350 IP54 high-ingress protection series VFD is used to control asynchronous AC induction motor and permanent-magnet synchronous motor. The figure below shows the main circuit diagram of the VFD. The rectifier converts 3PH AC voltage into DC voltage, and the capacitor bank of intermediate circuit stabilizes the DC voltage. The inverter converts DC voltage into the AC voltage used by AC motor. When the circuit voltage exceeds the maximum limit value, external brake resistor will be connected to intermediate DC circuit to consume the feedback energy.

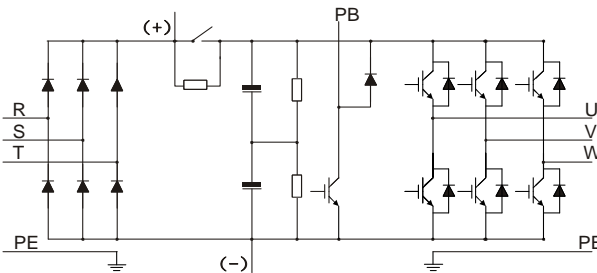

Figure 3-1 (015G/018P and below) main circuit diagram

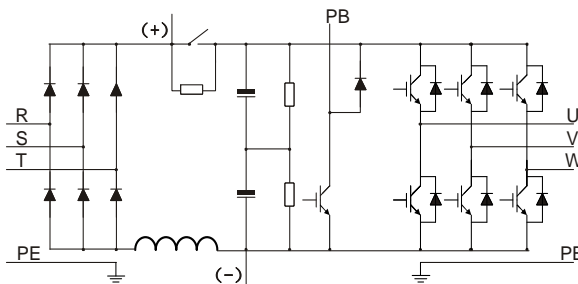

Figure 3-2 018G/022P-110G/132P (inclusive) main circuit diagram

Note:

1. VFDs of 018G/022P-110G/132P (inclusive) are equipped with built-in DC reactors.
2. Built-in brake units are included in the standard configuration of 037G/045P or lower models. The models that carry built-in brake units can also be connected to external brake resistors. The brake resistors are optional parts.

3. VFDs of 045G/055P–110G/132P models support optional built-in brake units. A VFD model with built-in brake unit ends with "-B", for example, GD350-045G-45-B.

3.3 Product specification

Function description		Specification
Power input	Input voltage (V)	-4 model: 3PH 380V (-15%)–440V (+10%)
	Input current (A)	See section 3.6 Rated values
	Input frequency (Hz)	50Hz or 60Hz, allowable range: 47–63Hz
Power output	Output voltage (V)	0–input voltage
	Output current (A)	See section 3.6 Rated values
	Output power (kW)	See 3.6 Rated values
	Output frequency (Hz)	0–400Hz
Technical control performance	Control mode	SVPWM control, SVC, VC
	Motor type	Asynchronous motor, permanent-magnet synchronous motor
	Speed regulation ratio	Asynchronous motor 1: 200 (SVC); Synchronous motor 1: 20 (SVC) , 1:1000 (VC)
	Speed control precision	±0.2% (SVC), ±0.02% (VC)
	Speed fluctuation	± 0.3% (SVC)
	Torque response	<20ms SVC) , <10ms (VC)
	Torque control precision	10% (SVC) , 5% (VC)
	Starting torque	Asynchronous motor: 0.25Hz/150% (SVC) Synchronous motor: 2.5 Hz/150% (SVC) 0Hz/200% (VC)
Overload capacity	G type: 150% of rated current: 1min; 180% of rated current: 10s; 200% of rated current: 1s; P type: 120% of rated current: 1min;	
Running control performance	Frequency setup mode	Digital, analog, pulse frequency, multi-step speed running, simple PLC, PID, Modbus communication, PROFIBUS communication, etc; Realize switch-over between the set combination and the set channel
	Automatic voltage regulation function	Keep the output voltage constant when grid voltage changes
	Fault protection function	Fault protection function Provide over 30 kinds of fault protection functions: overcurrent, overvoltage, undervoltage, over-temperature, phase loss and overload, etc

Function description		Specification
	Speed tracking restart function	Realize impact-free starting of the motor in rotating Note: This function is available for 004G/5R5G and above models
Peripheral interface	Terminal analog input resolution	No more than 20mV
	Terminal digital input resolution	No more than 2ms
	Analog input	2 inputs, AI1: 0–10V/0–20mA; AI2: -10–10V
	Analog output	1 output, AO1: 0–10V /0–20mA
	Digital input	Four regular inputs; max. frequency: 1kHz; internal impedance: 3.3kΩ Two high-speed inputs; max. frequency: 50kHz; supports quadrature encoder input; with speed measurement function
	Digital output	One high-speed pulse output; max. frequency: 50kHz One Y terminal open collector output
	Relay output	Two programmable relay outputs RO1A NO, RO1B NC, RO1C common port RO2A NO, RO2B NC, RO2C common port Contact capacity: 3A/AC250V, 1A/DC30V
	Extension interface	Three extension interfaces: SLOT1, SLOT2, SLOT3 Expandable PG card, programmable extension card, communication card, I/O card, etc
Others	Installation mode	Support wall-mounting and flange-mounting
	Operation ambient temperature	-10–50°C Derating is required if the ambient temperature exceeds 40°C
	Ingress protection rating	IP54
	Cooling mode	Forced-air cooling
	Brake unit	Built-in brake units are included in the standard configuration of 37kW or lower VFDs. VFDs of 45–110kW support optional built-in brake units. A VFD model with built-in brake unit ends with "-B", for example, GD350-045G-45-B.
	EMC filter	Conducted emissions of all 380V models meet the requirements of C3 in the IEC/EN 61800-3 standard. External filter is optional: Conducted emission can meet the requirements of C2 in the IEC/EN 61800-3 standard.

Function description		Specification
		Note: It is required to observe the EMC compliance required by the appendix of the manual. The motor and motor cables shall be selected based on technical requirements specified in the appendix of the manual.
	STO certification level	Meet the SIL2 level

3.4 Product nameplate

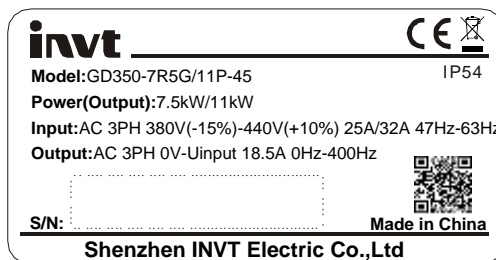

Figure 3–3 Product nameplate

Note:

1. This is an example of the nameplate of standard Goodrive350 IP54 products. The CE/TUV/IP54 marking on the top right will be marked according to actual certification conditions.
2. Scan the QR code on the bottom right to download mobile APP and operation manual.

3.5 Model code

The model code contains product information. Users can find the model code on the nameplate and simple nameplate of the VFD.

GD350-022G/030P-4 5
①
②
③
④

Figure 3–4 Model code

Field	Sign	Description	Contents
Product Category	①	Abbreviation of product series	GD350: Goodrive350 high-performance multi-function VFD
Rated power	②	Power range + load type	022/030: 22kW G—Constant torque load P—Fan and water pump
Voltage level	③	Voltage level	4: AC 3PH 380V (-15%)–440V (+10%) Rated voltage: 380V

Field	Sign	Description	Contents
Ingress protection rating	④	Ingress protection rating	5: IP54 ingress protection rating (It is impossible to completely prevent dust from entering, but the amount of dust from entering will not cause damage to the equipment; it will not cause damage when the product is immersed in water from each direction).

3.6 Rated values

Product model	Constant torque			Variable torque		
	Output power (kW)	Input current (A)	Output current (A)	Output power (kW)	Input current (A)	Output current (A)
GD350-004G/5R5P-45	4	13.5	9.5	5.5	19.5	14
GD350-5R5G/7R5P-45	5.5	19.5	14	7.5	25	18.5
GD350-7R5G/011P-45	7.5	25	18.5	11	32	25
GD350-011G/015P-45	11	32	25	15	40	32
GD350-015G/018P-45	15	40	32	18.5	47	38
GD350-018G/022P-45	18.5	47	38	22	51	45
GD350-022G/030P-45	22	51	45	30	70	60
GD350-030G/037P-45	30	70	60	37	80	75
GD350-037G/045P-45	37	80	75	45	98	92
GD350-045G/055P-45	45	98	92	55	128	115
GD350-055G/075P-45	55	128	115	75	139	150

Note:

1. The input current of 004G/5R5P–055G/075P VFDs are measured in cases where the input voltage is 380V without additional reactors;
2. The rated output current is the output current when the output voltage is 380V;
3. Within allowable input voltage range, the output current/power cannot exceed rated output current/power.

3.7 Structure diagram

The VFD layout is shown in the figure below (take a 015G/018P VFD as an example).

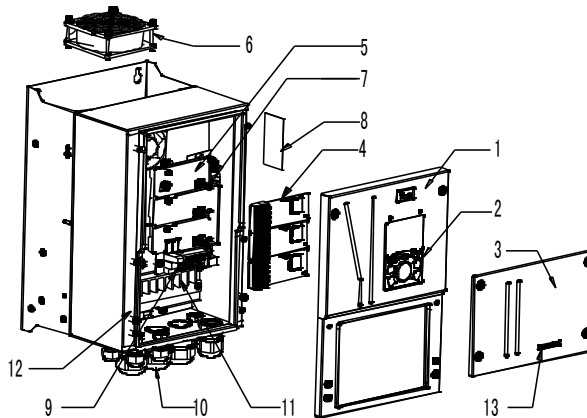



Figure 3–5 Structure diagram

No.	Name	Instruction
1	Upper cover	Protect internal components and parts
2	Keypad	For details, see section 5.4 "Keypad operation"
3	Lower cover	Protect internal components and parts
4	Extension card	Optional. For details, see Appendix A "Extension cards"
5	Baffle of control board	Protect the control board and install extension card
6	Cooling fan	For details, see chapter 8 "Routine maintenance"
7	Keypad interface	Connect the keypad
8	Nameplate	For details, see chapter 3 "Product overview"
9	Control terminals	For details, see chapter 4 "Installation guide"
10	Waterproof connector	Lock and secure connection cables
11	Main circuit terminal	For details, see chapter 4 "Installation guide"
12	POWER indicator	Power indicator
13	Label of GD350 IP54 product series	For details, see section 3.5 "Model code" of this chapter

4 Installation guide

4.1 What this chapter contains

This chapter introduces the mechanical and electrical installations of the VFD.

	<ul style="list-style-type: none"> ✧ Only well trained and qualified professionals are allowed to carry out the operations mentioned in this chapter. Please carry out operations according to instructions presented in 1 "Safety precautions". Ignoring these safety precautions may lead to physical injury or death, or device damage. ✧ Ensure the VFD power is disconnected before installation. If the VFD has been powered on, disconnect the VFD and wait for at least the time designated on the VFD, and ensure the POWER indicator is off. Users are recommended to use a multimeter to check and ensure the VFD DC bus voltage is below 36V. ✧ Installation must be designed and done according to applicable local laws and regulations. INVT does not assume any liability whatsoever for any installation which breaches local laws and regulations. If recommendations given by INVT are not followed, the VFD may experience problems that the warranty does not cover.
---	--

4.2 Mechanical installation

4.2.1 Installation environment

Installation environment is essential for the VFD to operate at its best in the long run. The installation environment of the VFD should meet the following requirements.

Environment	Condition
Installation site	Indoors
Ambient temperature	<ul style="list-style-type: none"> ✧ -10—+50°C; ✧ When the ambient temperature exceeds 40°C, derate 1% for every additional 1°C; ✧ It is not recommended to use the VFD when the ambient temperature is above 50°C; ✧ In order to improve reliability, do not use the VFD in cases where the temperature changes rapidly; ✧ When the VFD is used in a closed space eg control cabinet, use cooling fan or air conditioner to prevent internal temperature from exceeding the temperature required; ✧ When the temperature is too low, if restart a VFD which has been idled for a long time, it is required to install external heating device before use to eliminate the freeze inside the VFD, failing to do so may cause damage to the VFD.

Environment	Condition
Humidity	<ul style="list-style-type: none"> ✧ The relative humidity (RH) of the air is less than 90%; ✧ The max RH cannot exceed 60% in the environment where there are corrosive gases.
Storage temperature	-30—+60°C
Running environment	<p>The installation site should meet the following requirements.</p> <ul style="list-style-type: none"> ✧ Away from electromagnetic radiation sources; ✧ Away from oil mist, corrosive gases and combustible gases; ✧ Ensure foreign object like metal powder will not fall into the VFD (do not install the VFD onto combustible object like wood); ✧ Away from radioactive substance and combustible objects; ✧ Away from corrosive liquid; ✧ Low salt content; ✧ No direct sunlight
Altitude	<ul style="list-style-type: none"> ✧ Below 1000m; ✧ When the altitude exceeds 1000m, derate 1% for every additional 100m. ✧ When the installation site altitude exceeds 3000m, consult the local INVT dealer or office.
Vibration	The max. amplitude of vibration should not exceed 5.8m/s^2 (0.6g)
Installation direction	Install the VFD vertically to ensure good heat dissipation effect

Note: GD350 IP54 series VFDs must be installed in ventilated environments free of corrosive gases and conductive dust.

4.2.2 Installation direction

The VFD can be installed on the wall or in a cabinet.

The VFD must be installed vertically. Check the installation position according to following requirements. See Appendix C "Dimension drawings" for detailed outline dimensions.

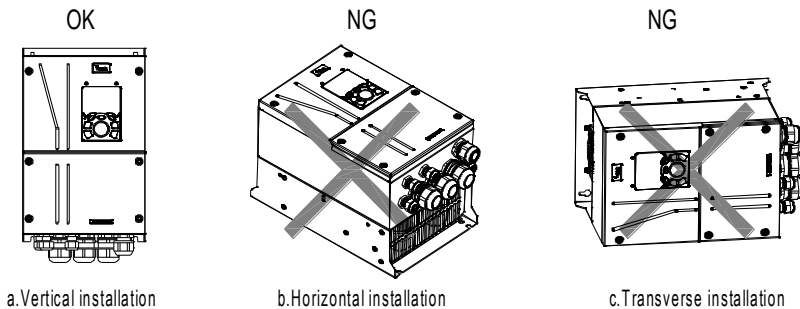

Figure 4–1 Installation direction of the VFD

4.2.3 Installation mode

The VFDs can be installed in two modes, depending on the different VFD dimensions:

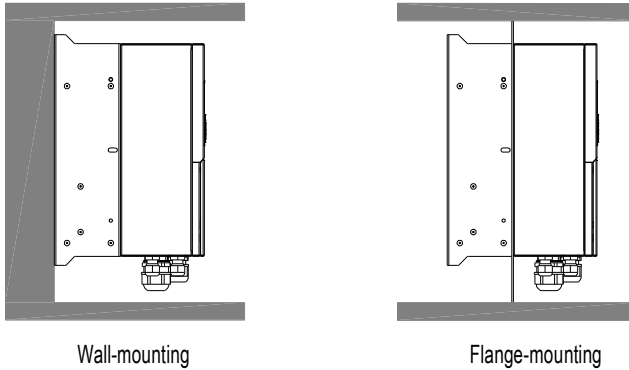

Figure 4-2 Installation mode

- (1) Mark the position of the installation hole. See Appendix C "Dimension drawings" for the position of installation hole;
- (2) Mount the screws or bolts onto the designated position;
- (3) Put the VFD on the wall;
- (4) Tighten the fixing screws on the wall.

Note: Flange-mounting plate is a must for 004G/5R5P-110G/132P VFDs that adopt flange-mounting mode.

4.2.4 Single-unit installation

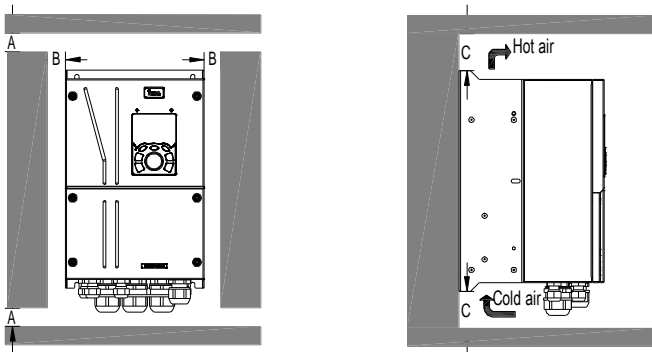

Figure 4-3 Single-unit installation

Note: The min. dimension of B and C is 100mm.

4.2.5 Multiple-unit installation

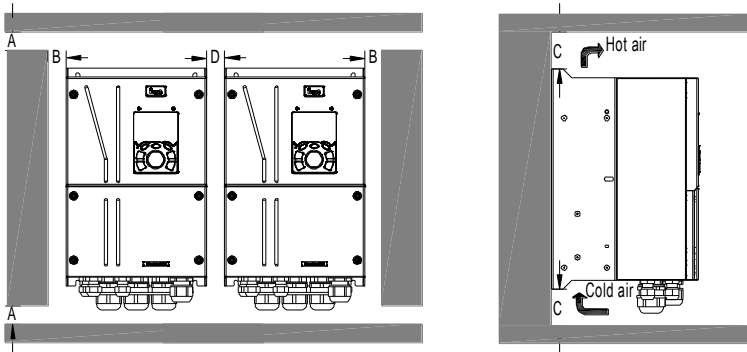

Figure 4-4 Parallel installation

Note:

1. When users install VFDs in different sizes, align the top of each VFD before installation for the convenience of future maintenance.
2. The min dimension of B and C is 100mm, and the dimension of D can be 0, that is zero-clearance parallel installation is supported.

4.2.6 Vertical installation

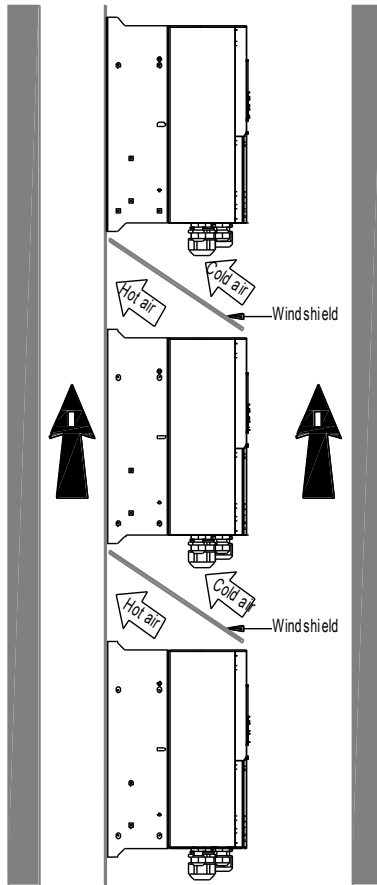

Figure 4-5 Vertical installation

Note: During vertical installation, users must install windshield, otherwise, the VFD will experience mutual interference, and the heat dissipation effect will be degraded.

4.2.7 Tilted installation

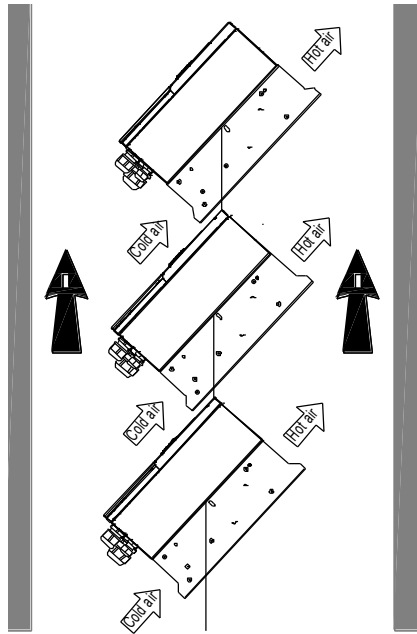

Figure 4-6 Tilted installation

Note: During tilted installation, it is a must to ensure the air inlet duct and air outlet duct are separated from each other to avoid mutual interference.

4.3 Standard wiring of main circuit

4.3.1 Wiring diagram of main circuit

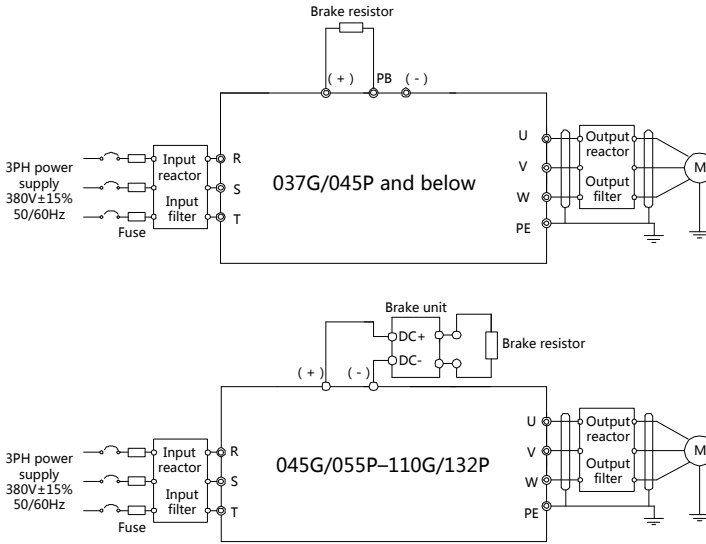

Figure 4-7 Main circuit wiring diagram

Note:

1. The fuse, DC reactor, brake unit, brake resistor, input reactor, input filter, output reactor and output filter are optional parts. See Appendix D "Optional peripheral accessories" for details.
2. When connecting the brake resistor, take off the yellow warning sign marked with PB, (+) and (-) on the terminal block before connecting the brake resistor wire, otherwise, poor contact may occur.

4.3.2 Main circuit terminal diagram

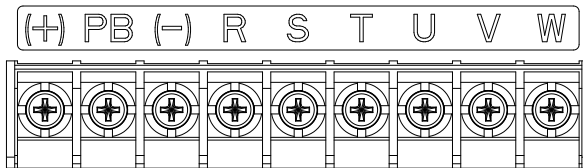

Figure 4-8 022G/030P and below

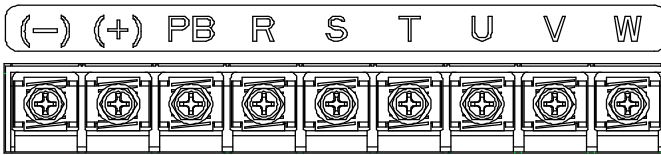

Figure 4-9 030G/037P-037G/045P

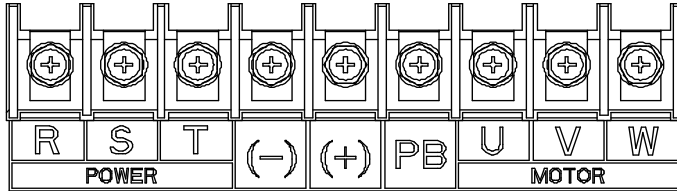

Figure 4-10 045G/055P-110G/132P (Enabling PB when a braking unit is embedded)

Terminal sign	Terminal name		Function description
	037G/045P and below	045G/055P-110G/132P	
R, S, T	Main circuit power input		3PH AC input terminal, connect to the grid
U, V, W	VFD output		3PH AC output terminal, connect to the motor
(+)	Brake resistor terminal 1	Brake unit terminal 1	(+) and (-) are connected with the terminals of brake unit.
(-)	/	Brake unit terminal 2	
PB	Brake resistor terminal 2	None	PB and (+) are connected with the terminals of brake resistor.
PE	Grounding resistor is less than 10 ohm		Grounding terminal for safe protection; each machine must carry two PE terminals and proper grounding is required

Note:

1. Do not use asymmetrical motor cable. If there is a symmetrical grounding conductor in the motor cable besides the conductive shielded layer, ground the grounding conductor on the VFD end and motor end.
2. Brake resistor, brake unit and DC reactor are optional parts.
3. Route the motor cable, input power cable and control cables separately.

4. "None" means this terminal is not for external connection.
5. GD series VFDs cannot share the DC bus with CH series VFDs.
6. When sharing the DC bus, the VFDs must be the same in power and must be simultaneously powered on or off.
7. In shared DC bus running mode, current balance on the VFD input side must be considered during wiring, and equalizing reactors are recommended to be configured.

4.3.3 Wiring process of the main circuit terminals

1. Connect the grounding line of the input power cable to the grounding terminal (PE) of the VFD, and connect the 3PH input cable to R, S and T terminals and tighten up.
2. Connect the grounding line of the motor cable to the grounding terminal of the VFD, and connect 3PH motor cable to U, V and W terminals and tighten up.
3. Connect the brake resistor which carries cables to the designated position.
4. Fix all the cables outside the VFD mechanically if allowed.

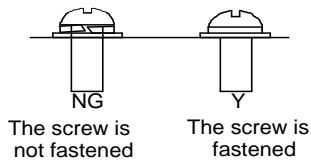

Figure 4–11 Screw installation diagram

4.4 Standard wiring of control circuit

4.4.1 Wiring diagram of basic control circuit

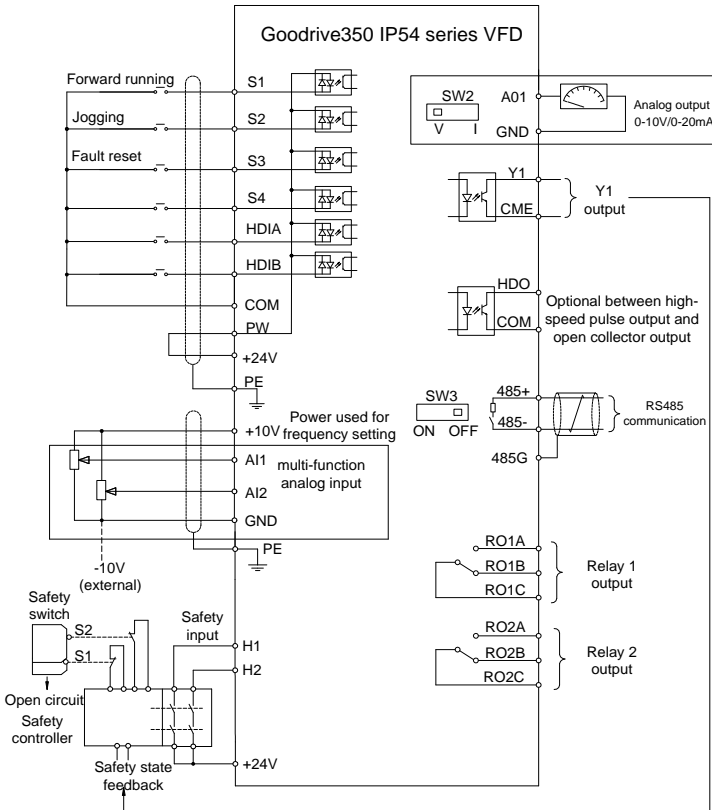

Figure 4-12 Wiring diagram of control circuit

Note: If wire-passing board outlet space is insufficient when all terminals on the control board are wired, cut the knock-out hole on the lower cover for wire outlet. If a dangerous situation occurs when the knock-out hole is cut for a purpose but not wire outlet, we will not bear any responsibility.

Terminal name	Instruction
+10V	The VFD provides +10.5V power
AI1	1. Input range: AI1 voltage/current can choose 0-10/ 0-20mA; AI2: -10V-+10V voltage;
AI2	2. Input impedance: 20kΩ during voltage input; 250Ω during current input; 3. AI1 voltage or current input is set by P05.50;

Terminal name	Instruction	
	4. Resolution ratio: When 10V corresponds to 50Hz, the min. resolution ratio is 5mV; 5. 25°C, When input above 5V or 10mA, the error is $\pm 0.5\%$	
GND	+10.5V reference zero potential	
AO1	1. Output range: 0–10V voltage or 0–20mA current 2. Voltage or current output is set by toggle switch SW2; 3. 25°C, when input above 5V or 10mA, the error is $\pm 0.5\%$.	
RO1A	RO1 relay output; RO1A is NO, RO1B is NC, RO1C is common port Contact capacity: 3A/AC250V, 1A/DC30V	
RO1B		
RO1C		
RO2A	RO2 relay output; RO2A is NO, RO2B is NC, RO2C is common port Contact capacity: 3A/AC250V, 1A/DC30V	
RO2B		
RO2C		
HDO	1. Switch capacity: 50mA/30V; 2. Range of output frequency: 0–50kHz 3. Duty ratio: 50%	
COM	Common port of +24V	
CME	Common port of open collector output; short connected to COM by default	
Y1	1. Switch capacity: 50mA/30V; 2. Range of output frequency: 0–1kHz	
485+	485 communication port, 485 differential signal port and standard 485 communication interface should use twisted shielded pair; the 120ohm terminal matching resistor of 485 communication is connected by toggle switch SW3.	
485-		
PE	Grounding terminal	
PW	Provide input digital working power from external to internal; Voltage range: 12–30V	
24V	The VFD provides user power; the max. output current is 200mA	
COM	Common port of +24V	
S1	Digital input 1	1. Internal impedance: 3.3k Ω 2. Accept 12–30V voltage input 3. This terminal is bi-directional input terminal and supports NPN/PNP connection modes 4. Max. input frequency: 1kHz 5. All are programmable digital input terminals, users can set the terminal function via function codes
S2	Digital input 2	
S3	Digital input 3	
S4	Digital input 4	
HDIA	Besides S1–S4 functions, it can also act as high frequency pulse input channel	
HDIB	Max. input frequency: 50kHz; Duty ratio: 30%–70%;	

Terminal name	Instruction	
	Supports the input of a quadrature encoder with 24V power supply; equipped with speed-measurement function	
+24V—H1	STO input 1	1. Safe torque off (STO) redundant input, connect to external NC contact, STO acts when the contact opens, and the VFD stops output;
+24V—H2	STO input 2	2. Safety input signal wires use shielded wire whose length is within 25m; 3. H1 and H2 terminals are short connected to +24V by default; it is required to remove the short-contact tag on the terminal before using STO function.

4.4.2 Input/output signal connection diagram

Set NPN /PNP mode and internal/external power via U-type short-contact tag. NPN internal mode is adopted by default.

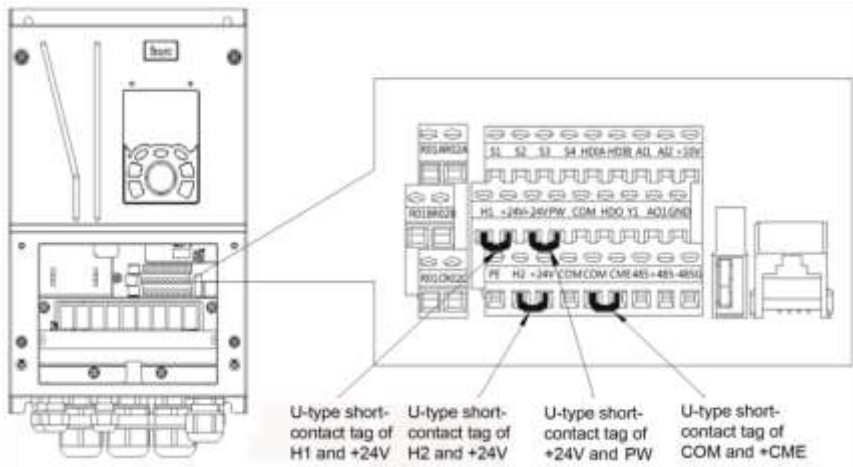

Figure 4–13 Position of U-type short-contact tag

If input signal comes from NPN transistors, set the U-type short-contact tag between +24V and PW based on the power used according to the figure below.

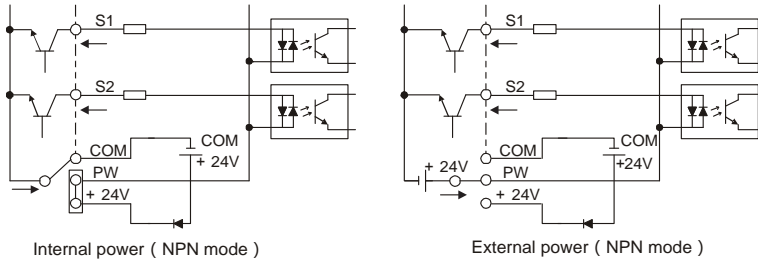

Figure 4-14 NPN mode

If input signal comes from PNP transistor, set the U-type short-contact tag based on the power used according to the figure below.

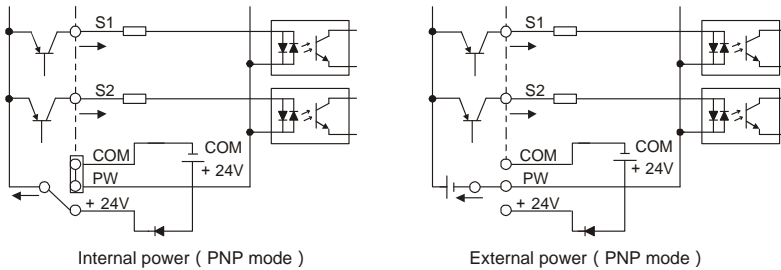

Figure 4-15 PNP mode

4.5 Wiring protection

4.5.1 Protect the VFD and input power cable in short-circuit

Protect the VFD and input power cable during short-circuit to avoid thermal overload.

Carry out protective measures according to the following requirements.

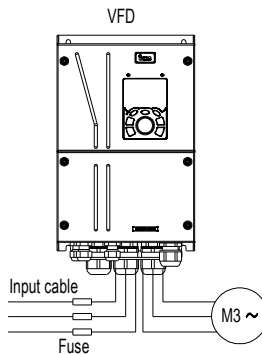

Figure 4-16 Fuse configuration

Note: Select the fuse according to operation manual. During short-circuit, the fuse will protect input power cables to avoid damage to the VFD; when internal short-circuit occurred to the VFD, it can protect neighboring equipment from being damaged.

4.5.2 Protect the motor and motor cable in short circuit

If the motor cable is selected based on rated VFD current, the VFD will be able to protect the motor cable and motor during short circuit without other protective devices.



⚡ If the VFD is connected to multiple motors, it is a must to use a separated thermal overload switch or breaker to protect the cable and motor, which may require the fuse to cut off the short circuit current.

4.5.3 Protect motor and prevent thermal overload

According to the requirements, the motor must be protected to prevent thermal overload. Once overload is detected, users must cut off the current. The VFD is equipped with motor thermal overload protection function, which will block output and cut off the current (if necessary) to protect the motor.

4.5.4 Bypass connection

In some critical occasions, industrial frequency conversion circuit is necessary to ensure proper operation of the system when VFD fault occurs.

In some special cases, eg, only soft startup is needed, it will converts to power-frequency operation directly after soft startup, corresponding bypass link is also needed.



⚡ Do not connect any power source to VFD output terminals U, V and W. The voltage applied to motor cable may cause permanent damage to the VFD.

If frequent switch-over is needed, users can use the switch which carries mechanical interlock or a contactor to ensure motor terminals will not be connected to input power cables and VFD output ends simultaneously.

5 Basic operation instructions

5.1 What this chapter contains

This chapter tells users how to use the VFD keypad and the commissioning procedures for common functions of the VFD.

5.2 Keypad introduction

LCD keypad is included in the standard configuration of GD350 IP54 series VFDs. Users can control the VFD start/stop, read state data and set parameters via keypad.















Figure 5-1 Keypad diagram

Note:

1. LCD keypad is armed with real-time clock, which can run properly after power off when installed with batteries. The clock battery (type: CR2032) should be purchased by the user separately.
2. LCD keypad support parameter-copy.

No.	Name	Instruction	
1	State Indicator	(1)	<p>RUN</p> <p>Running indicator; LED off – the VFD is stopped; LED blinking – the VFD is in parameter autotune LED on – the VFD is running</p>
		2)	<p>TRIP</p> <p>Fault indicator; LED on – in fault state LED off – in normal state LED blinking – in pre-alarm state</p>
		(3)	<p>QUICK/JOG</p> <p>Short-cut key indicator, which displays different state under different functions, see definition of QUICK/JOG key for details</p>

No.	Name	Instruction			
2	Button area	(4)		Function key	The function of function key varies with the menu; The function of function key is displayed in the footer
		(5)			
		(6)			
		(7)		Short-cut key	Re-definable. It is defined as JOG function by default, namely jogging. The function of short-cut key can be set by the ones of P07.12, as shown below. 0: No function ; 1: Jogging (linkage indicator (3); logic : NO); 2: Reserved; 3: FWD/REV switch-over (linkage indicator (3); logic: NC) ; 4: Clear UP/DOWN setting (linkage indicator (3) logic: NC) ; 5: Coast to stop (linkage indicator (3); logic: NC) ; 6: Switching running command reference mode in order (linkage indicator (3); logic: NC) ; 7: Reserved; Note: After restoring to default values, the default function of short-cut key (7) is 1.
		(8)		Confirmation key	The function of confirmation key varies with menus, eg confirming parameter setup, confirming parameter selection, entering the next menu, etc.
		(9)		Running key	Under keypad operation mode, the running key is used for running operation or autotuning operation.
		(10)		Stop/Reset key	During running state, press the Stop/Reset key can stop running or autotuning; this key is limited by P07.04. During fault alarm state, all the control modes can be reset by this key.

No.	Name	Instruction			
		(11)		Direction key UP:  DOWN:  LEFT:  RIGHT: 	UP: The function of UP key varies with interfaces, eg shifting up the displayed item, shifting up the selected item, changing digits, etc; DOWN: The function of DOWN key varies with interfaces, eg shifting down the displayed item, shifting down the selected item, changing digits, etc; LEFT: The function of LEFT key varies with interfaces, eg switch over the monitoring interface, eg shifting the cursor leftward, exiting current menu and returning to previous menu, etc; RIGHT: The function of RIGHT key varies with interfaces, eg switch over the monitoring interface, shifting the cursor rightward, enter the next menu etc.
3	Display area	(12)	LCD	Display screen	240x160 dot-matrix LCD; display three monitoring parameters or six sub-menu items simultaneously
4	Others	(13)	RJ45 interface	RJ45 interface	RJ45 interface is used to connect to the VFD.
		(14)	Battery holder	Clock battery holder	The battery holder is used for replacing or installing a battery for the clock.
		(15)	USB terminal	mini USB terminal	Mini USB terminal is used to connect to the USB flash drive through an adapter.

The LCD has different display areas, which displays different contents under different interfaces. The figure below is the main interface of stop state.

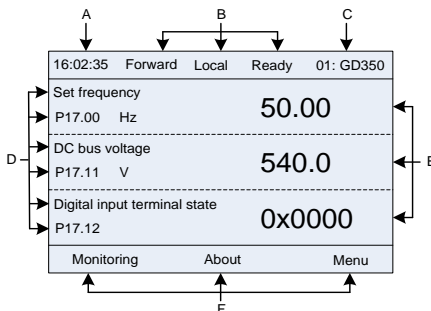

Figure 5-2 Main interface of LCD



Area	Name	Displayed contents
Header A	Real-time display area	Display the real-time; clock battery is not included; the time needs to be reset when powering on the VFD
Header B	VFD running state display area	Display the running state of the VFD: 1. Display motor rotating direction: "Forward" – Run forward during operation; Reverse – Run reversely during operation; "Forbid" – Reverse running is forbidden; 2. Display VFD running command channel: "Local" – Keypad; "Terminal"–Terminal; "Remote"–Communication 3. Display current running state of the VFD : "Ready" – The VFD is in stop state (no fault); "Run" – The VFD is in running state; "Jog"–The VFD is in jogging state; "Pre-alarm"–the VFD is under pre-alarm state during running; "Fault"–VFD fault occurred.
Header C	VFD station no. and model display area	1. Display VFD station no.: 01–99, applied in multi-drive applications (reserved function); 2. VFD model display: "GD350–current VFD is GD350 series VFD
Display D	The parameter name and function code monitored by the VFD	Display the parameter name and corresponding function code monitored by the VFD; three monitoring parameters can be displayed simultaneously. The monitoring parameter list can be edited by the user
Display E	Parameter value monitored by the VFD	Display the parameter value monitoring by the VFD, the monitoring value will be refreshed in real time
Footer F	Corresponding menu of function key (4), (5) and (6)	Corresponding menu of function key (4), (5) and (6). The corresponding menu of function key (4), (5) and (6) varies with interfaces, and the contents displayed in this area is also different

5.3 Keypad display

The display state of GD350 IP54 series keypad is divided into stop parameter display state, running parameter display state and fault alarm display state.

5.3.1 Stop parameter display state

When the VFD is in stop state, the keypad displays stop state parameters, and this interface is the main interface during power-up by default. Under stop state, parameters in various states can be displayed.

Press  or  to shift the displayed parameter up or down.

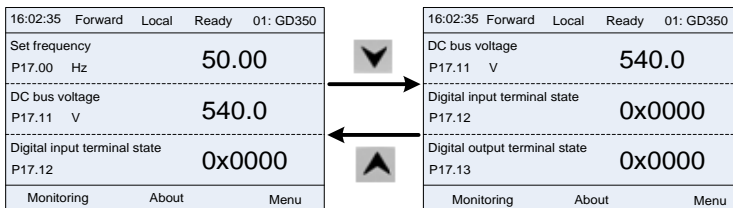



Figure 5-3 Stop parameter display state

Press  or  to switch between different display styles, including list display style and progress bar display style.

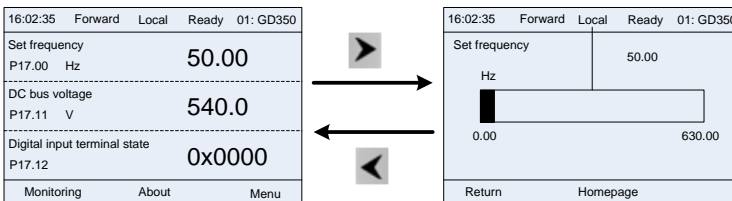







Figure 5-4 Stop parameter display state

The stop display parameter list is defined by the user, and each state variable function code can be added to the stop display parameter list as needed. The state variable which has been added to the stop display parameter list can also be deleted or shifted.

5.3.2 Running parameter display state

After receiving valid running command, the VFD will enter running state, and the keypad displays running state parameter with **RUN** indicator on the keypad turning on. Under running state, multiple kinds of state parameters can be displayed. Press  or  to shift up or down.

16:02:35	Forward	Local	Run	01: GD350
Output frequency	50.00			
P17.01	Hz			
Set frequency	50.00			
P17.00	Hz			
DC bus voltage	540.0			
P17.11	V			
Monitoring	About	Menu		







16:02:35	Forward	Local	Run	01: GD350
Set frequency	50.00			
P17.00	Hz			
DC bus voltage	540.0			
P17.11	V			
Output voltage	378			
P17.03	V			
Monitoring	About	Menu		

Figure 5-5 Running parameter display state

Press  or  to switch between different display styles, including list display style and progress bar display style.

16:02:35	Forward	Local	Ready	01: GD350
DC bus voltage	540.00			
P17.11	V			
Digital input terminal state	0x0000			
P17.12				
Digital output terminal state	0x0000			
P17.13				
Monitoring	About	Menu		

16:02:35	Forward	Local	Ready	01: GD350
DC bus voltage	540.00			
V				
				
0.0				2000.0
Return	Homepage			

Figure 5-6 Running parameter display state

Under running state, multiple kinds of state parameters can be displayed. The running display parameter list is defined by the user, and each state variable function code can be added to the running display parameter list as needed. The state variable which has been added to the running display parameter list can also be deleted or shifted.

5.3.3 Fault alarm display state

The VFD enters fault alarm display state once fault signal is detected, and the keypad displays fault code and fault information with **TRIP** indicator on the keypad turning on. Fault reset operation can be carried out via **STOP/RST** key, control terminal or communication command.

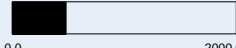
The fault code will be kept displaying until fault is removed.

16:02:35	Forward	Local	Fault	01: GD350
Type of present fault:				
Fault code:				
19				
19: Current detection fault (ITE)				
Return	Homepage	Confirm		

Figure 5-7 Fault alarm display state

5.4 Keypad operation

Various operations can be performed on the VFD, including entering/exiting menu, parameter selection, list modification and parameter addition.

5.4.1 Enter/exit menu

Regarding the monitoring menu, the operation relation between enter and exit is shown below.

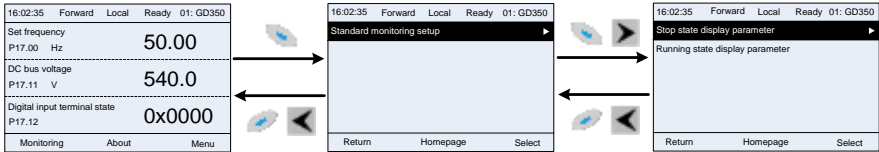

Figure 5–8 Enter/exit menu diagram 1

Regarding the system menu, the operation relation between enter and exit is shown in the following figure.

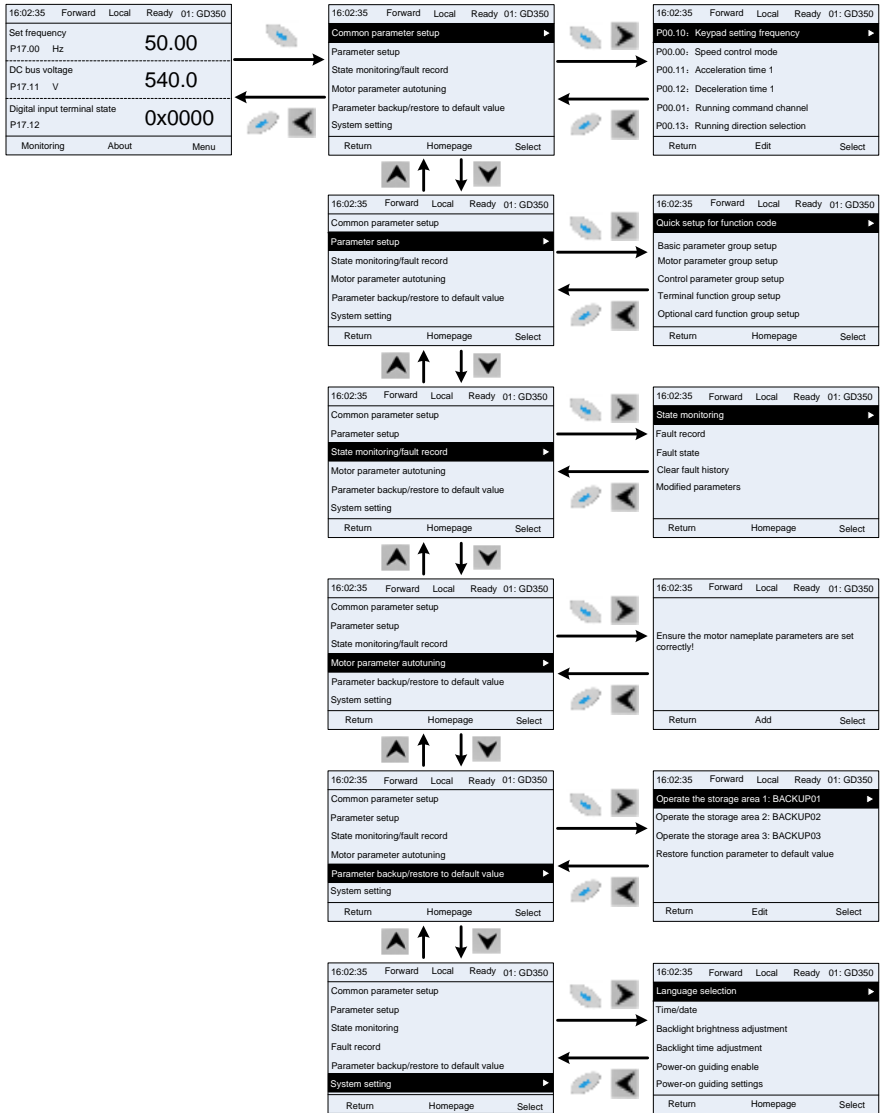

Figure 5-9 Enter/exit menu diagram 2

The keypad menu setup is shown as below.

First-level	Second-level	Third-level	Fourth-level
Common parameter setup	/	/	P00.10: Set frequency via keypad
			P00.00: Speed control mode
			Pxx.xx : Common parameter setup xx
	Quick setup for function code	/	Pxx.xx
Parameter setup	Basic parameter group setup	P00: Basic function group	P00.xx
		P07: HMI group	P07.xx
		P08: Enhance function group	P08.xx
		P11: Protection parameter group	P11.xx
		P14: Serial communication function group	P14.xx
		P99: Factory function group	P99.xx
	Motor parameter group setup	P02: Motor 1 parameter group	P02.xx
		P12: Motor 2 parameter group	P12.xx
		P20: Motor 1 encoder group	P20.xx
		P24: Motor 2 encoder group	P24.xx
	Control parameter group setup	P01: Start/stop control group	P01.xx
		P03: Motor 1 vector control group	P03.xx
		P04: V/F control group	P04.xx
		P09: PID control group	P09.xx
		P10: Simple PLC and multi-step speed control group	P10.xx
		P13: Synchronous motor control parameter group	P13.xx
		P21: Position control group	P21.xx
		P22: Spindle positioning group	P22.xx

First-level	Second-level	Third-level	Fourth-level	
	Terminal function group setup	P23: Motor 2 vector control group	P23.xx	
		P05: Input terminal group	P05.xx	
		P06: Output terminal group	P06.xx	
	Optional card function group setup	P98: AIAO calibration function group	P98.xx	
		P15: Communication extension card 1 function group	P15.xx	
		P16: Communication extension card 2 function group	P16.xx	
		P25: Extension I/O card input function group	P25.xx	
		P26: Extension I/O card output function group	P26.xx	
		P27: PLC function group	P27.xx	
		P28: Master/slave function group	P28.xx	
	Default function group setup	P90: Customized function group 1	P90.xx	
		P91: Customized function group 2	P91.xx	
		P92: Customized function group 3	P92.xx	
		P93: Customized function group 4	P93.xx	
	State monitoring/fault record	State monitoring	P07: HMI group	P07.xx
			P17: State-check function group	P17.xx
P18: Closed-loop vector state check function group			P18.xx	
P19: Extension card state check function group			P19.xx	
Fault record		/		P07.27: Type of present fault
				P07.28: Type of the last fault
				P07.29: Type of the last but one fault

First-level	Second-level	Third-level	Fourth-level	
			P07.30: Type of the last but two fault	
			P07.31: Type of the last but three fault	
			P07.32: Type of the last but four fault	
	Fault state	/		P07.33: Running frequency of present fault
				P07.34: Ramps frequency of present fault
				P07.xx: xx state of the last but xx fault
	Clear fault history	/		Ensure to clear fault history?
	Modified parameter	/		Pxx.xx has modified parameter 1
				Pxx.xx has modified parameter 2
				Pxx.xx has modified parameter xx
Motor parameter autotuning	/	/	Complete parameter rotary autotuning	
			Complete parameter static autotuning	
			Partial parameter static autotuning	
Parameter backup/restore default value	/	Operate the storage area 1: BACKUP01	Upload local function parameter to keypad	
			Download complete keypad function parameter	
			Download key function parameters which are not in motor group	
		Download keypad function parameters which are in motor group		
		Operate the storage area 2: BACKUP012		
Operate the storage area 3: BACKUP03				

First-level	Second-level	Third-level	Fourth-level
		Restore function parameter to default value	Ensure to restore function parameters to default value?
System setup	/	/	Language selection
			Time/date
			Backlight brightness regulation
			Backlight time adjustment
			Power-on guiding enable
			Power-on guiding settings
			Keyboard burning selection
			Fault time enable
			Control board burning selection

5.4.2 List edit

The monitoring items displayed in the parameter list of stop state can be added by users as needed (through the menu of the function code in state check group), and the list can also be edited by users eg "shift up", "shift down" and "delete from the list". The edit function is shown in the interface below.

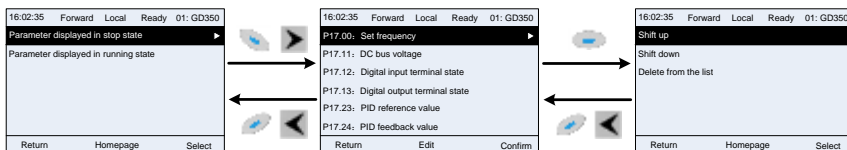

Figure 5-10 List edit diagram 1

Press key to enter edit interface, select the operation needed, and press key, key or key to confirm the edit operation and return to the previous menu (parameter list), the returned list is the list edited. If key or key is pressed in edit interface without selecting edit operation, it will return to the previous menu (parameter list remain unchanged).

Note: For the parameter objects in the list header, shift-up operation will be invalid, and the same principle can be applied to the parameter objects in the list footer; after deleting a certain parameter, the parameter objects under it will be shifted up automatically.

The monitoring items displayed in the parameter list of running state can be added by users as needed (through the menu of the function code in state check group), and the list can also be edited by users eg "shift up", "shift down" and "delete from the list". The edit function is shown in the interface below.

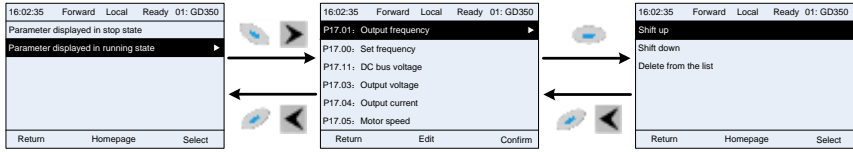

Figure 5-11 List edit diagram 2

The parameter list of common parameter setup can be added, deleted or adjusted by users as needed, including delete, shift-up and shift-down; the addition function can be set in a certain function code of a function group. The edit function is shown in the figure below.

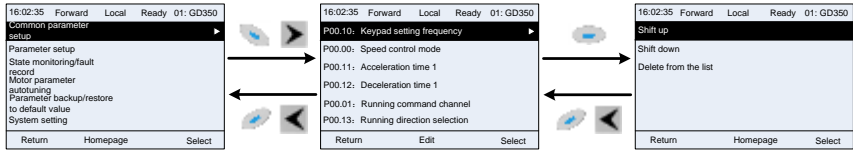

Figure 5-12 List edit diagram 3

5.4.3 Add parameters to the parameter list displayed in stop/running state

In the fourth-level menu of "State monitoring", the parameters in the list can be added to the "parameter displayed in stop state" list or "parameter displayed in running state" list as shown below.

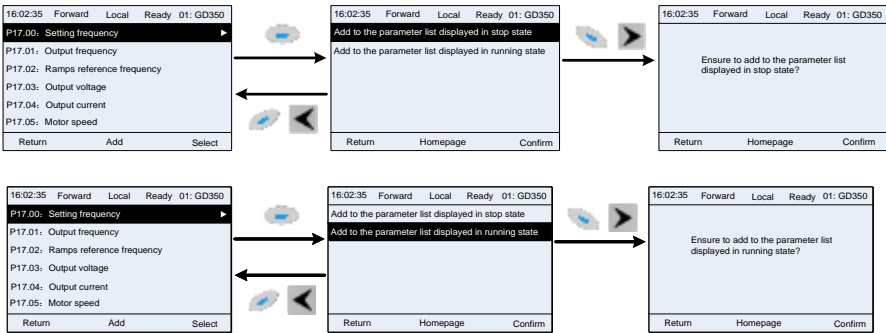

Figure 5-13 Add parameter diagram 1

Press key to enter parameter addition interface, select the operation needed, and press key, key or key to confirm the addition operation. If this parameter is not included in the "parameter displayed in stop state" list or "parameter displayed in running state" list, the parameter added will be at the end of the list; if the parameter is already in the "parameter displayed in stop state" list or "parameter displayed in running state" list, the addition operation will be invalid. If key or key is pressed without selecting addition operation in "Addition" interface, it will return to monitoring parameter list menu.

Part of the monitoring parameters in P07 HMI group can be added to the "parameter displayed in stop state" list or "parameter displayed in running state" list; All the parameters in P17, P18 and P19 group can be added to the "parameter displayed in stop state" list or "parameter displayed in running state" list.

Up to 16 monitoring parameters can be added to the "parameter displayed in stop state" list; and up to 32 monitoring parameters can be added to the "parameter displayed in running state" list.

5.4.4 Add parameter to common parameter setup list

In fourth-level menu of "parameter setup" menu, the parameter in the list can be added to the "common parameter setup" list as shown below.

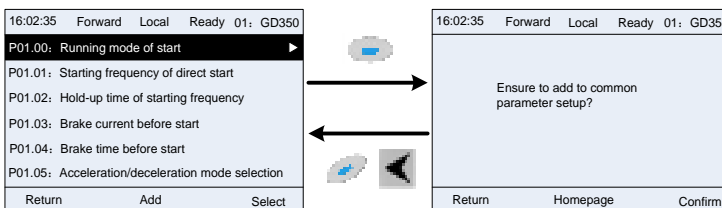

Figure 5–14 Add parameter diagram 2

Add key to enter addition interface, and press key, key or key to confirm the addition operation. If this parameter is not included in the original "common parameter setup" list, the newly-added parameter will be at the end of the list; if this parameter is already in the "common parameter setup" list, the addition operation will be invalid. If key or key is pressed without selecting addition operation, it will return to parameter setup list menu.

All the function code groups under parameter setup sub-menu can be added to "common parameter setup" list. Up to 64 function codes can be added to the "common parameter setup" list.

5.4.5 Parameter selection edit interface

In the fourth-level menu of "parameter setup" menu, press key, key or key to enter parameter selection edit interface. After entering edit interface, current value will be highlighted. Press key and key to edit current parameter value, and the corresponding parameter item of current value will be highlighted automatically. After parameter selection is done, press key or key to save the selected parameter and return to the previous menu. In parameter selection edit interface, press key to maintain the parameter value and return to the previous menu.

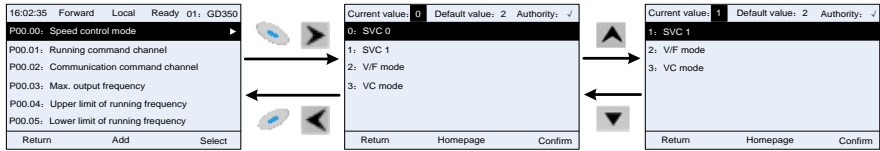

Figure 5-15 Parameter selection edit interface

In parameter selection edit interface, the "authority" on the top right indicates whether this parameter is editable or not.

"√" indicates the set value of this parameter can be modified under current state.

"x" indicates the set value of this parameter cannot be modified under current state.

"Current value" indicates the value of current option.

"Default value" indicates the default value of this parameter.

5.4.6 Parameter setup edit interface

In the fourth-level menu in "parameter setup" menu, press key, key or key to enter parameter setup edit interface. After entering edit interface, set the parameter from low bit to high bit, and the bit under setting will be highlighted. Press key or key to increase or decrease the parameter value (this operation is valid until the parameter value exceeds the max. value or min. value); press or to shift the edit bit. After parameters are set, press key or key to save the set parameters and return to the previous parameter. In parameter setup edit interface, press to maintain the original parameter value and return to the previous menu.

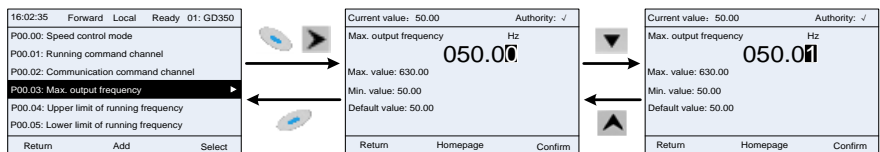

Figure 5-16 Parameter setup edit interface

In parameter selection edit interface, the "authority" on the top right indicates whether this parameter can be modified or not.

"√" indicates the set value of this parameter can be modified under current state.

"x" indicates the set value of this parameter cannot be modified under current state.

"Current value" indicates the value saved last time.

"Default value" indicates the default value of this parameter.

5.4.7 State monitoring interface

In the fourth-level menu of "state monitoring/fault record" menu, press key, key or key or

key to enter state monitoring interface. After entering state monitoring interface, the current parameter value will be displayed in real time, this value is the actually detected value which cannot be modified.

In state monitoring interface, press key or key to return to the previous menu.

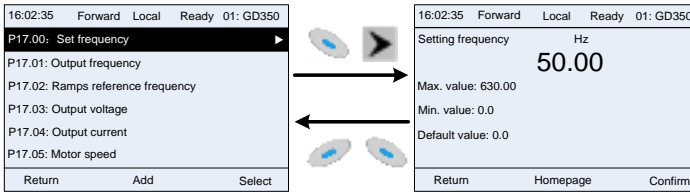

Figure 5-17 State monitoring interface

5.4.8 Motor parameter autotuning

In "Motor parameter autotuning" menu, press key, key or key to enter motor parameter autotuning selection interface, however, before entering motor parameter autotuning interface, users must set the motor nameplate parameters correctly. After entering the interface, select motor autotuning type to carry out motor parameter autotuning. In motor parameter autotuning

interface, press key or key to return to the previous menu.

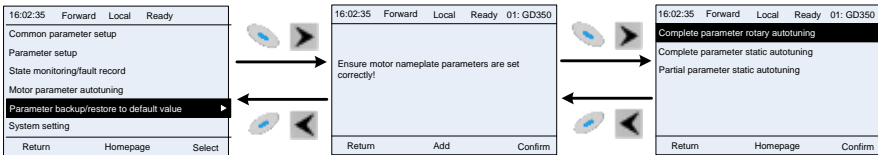

Figure 5-18 Parameter autotuning operation diagram

After selecting motor autotuning type, enter motor parameter autotuning interface, and press **RUN** key to start motor parameter autotuning. After autotuning is done, a prompt will pop out indicating autotuning is succeeded, and then it will return to the main interface of stop. During autotuning, users can press **STOP/RST** key to terminate autotuning; if any fault occur during autotuning, the keypad will pop out a fault interface.

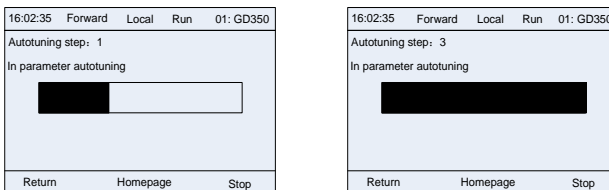

Figure 5-19 Parameter autotuning finished

5.4.9 Parameter backup

In "parameter backup" menu, press key, key or key to enter function parameter backup setting interface and function parameter restoration setup interface to upload/download VFD

parameters, or restore VFD parameters to default value. The keypad has three different storage areas for parameter backup, and each storage area can save the parameters of one VFD, namely it can save parameters of three VFD in total.

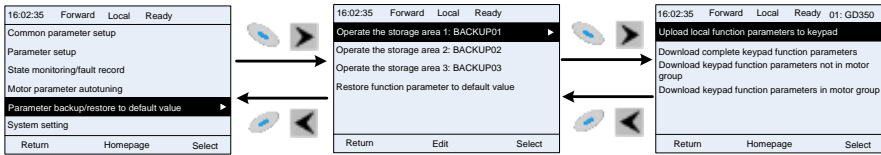

Figure 5-20 Parameter backup operation diagram

5.4.10 System setup

In "System setup" menu, press key, key or key to enter system setup interface to set keypad language, time/date, backlight brightness, backlight time and restore parameters.

Note: Clock battery is not included, and the keypad time/date needs to be reset after power off. If time-keeping after power off is needed, users should purchase the clock batteries separately.

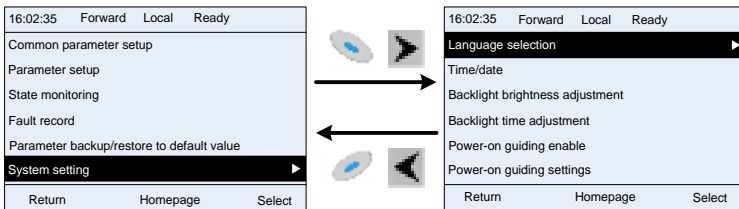

Figure 5-21 System setup diagram

5.4.11 Power-on guiding settings

The keyboard supports the power-on guiding function, mainly for the first power-on situation, guiding the user to enter the setting menu, and gradually implementing basic functions such as basic parameter setting, direction judgment, mode setting and autotuning. The power-on guiding enable menu guides the user to enable power-on to boot each time. Power-on guiding setup menu guides the user to set step by step according to the functions.

The power-on guide is shown as below.

First-level		Second-level		Third-level		Fourth-level	
Language	0: Simplified Chinese	Power-on guiding enable	0: Powe-on each time	Whether to enter the power-on guiding settings?	0:Yes	Whether to test the motor rotation direction?	Yes
	1: English		1: Power on only once		1:No		No

First-level		Second-level		Third-level		Fourth-level	
				P00.06 A frequency command selection A frequency command selection	0: Set via keypad	Press the JOG button first. It is currently forward, Is it consistent with the expectations?	Yes
					1: Set via AI1		No
					2: Set via AI2	P02.00 Type of motor 1	0: Asynchronous motor
					3: Set via AI3		1: Synchronous motor
					4: Set via high-speed pulse HDIA	P02.01 Rated power of asynchronous motor 1	
					5: Set via simple PLC program	P02.02 Rated frequency of asynchronous motor 1	
					6: Set via multi-step speed running	P02.03 Rated speed of asynchronous motor 1	
					7: Set via PID control	P02.04 Rated voltage of asynchronous motor 1	
					8: Set via Modbus communication	P02.05 Rated current of asynchronous motor 1	
					9: Set via PROFIBUS/CANopen/	P02.15 Rated power of synchronous	

First-level		Second-level		Third-level		Fourth-level	
					DeviceNet communication	motor 1	
					10: Set via Ethernet communication	P02.16 Rated frequency of synchronous motor 1	
					11: Set via high-speed pulse HDIB	P02.17 Number of pole pairs of synchronous motor 1	
					12: Set via pulse string AB	P02.18 Rated voltage of synchronous motor 1	
					13: Set via EtherCAT/PROFINET communication	P02.19 Rated current of synchronous motor 1	
					14: Set via PLC card	Whether to conduct autotuning?	Yes
					15: Reserved		No
				P00.01 Running command channel	0: Keypad	Motor parameter autotuning interface	
					1: Terminal		
					2: Communication		
				P00.02 Communication running command channel	0: Modbus		
					1: PROFIBUS/CANopen/DeviceNet		
					2: Ethernet		

First-level		Second-level		Third-level	Fourth-level		
				Communication running command channel	3: EtherCAT/P ROFINET		
					4: PLC programmable card		
					5: Bluetooth card		
				P08.37 Enable/disable energy-consumption brake	0: Disable energy-consumption		
					1: Enable energy-consumption		
				P00.00 Speed control mode	0: SVC 0		
					1: SVC 1		
					2: VF control		
					3: VC		
				P01.08 Stop mode	0: Decelerate to stop		
					1: Coast to stop		
				P00.11 Acceleration time			
				P00.12 Deceleration time			

5.5 Basic operation instruction

5.5.1 What this section contains

This section introduces the function modules inside the VFD

	<ul style="list-style-type: none"> ◇ Ensure all the terminals are fixed and tightened firmly. ◇ Ensure the motor matches with the VFD power.
---	--

5.5.2 Common commissioning procedures

The common operation procedures are shown below (take motor 1 as an example).

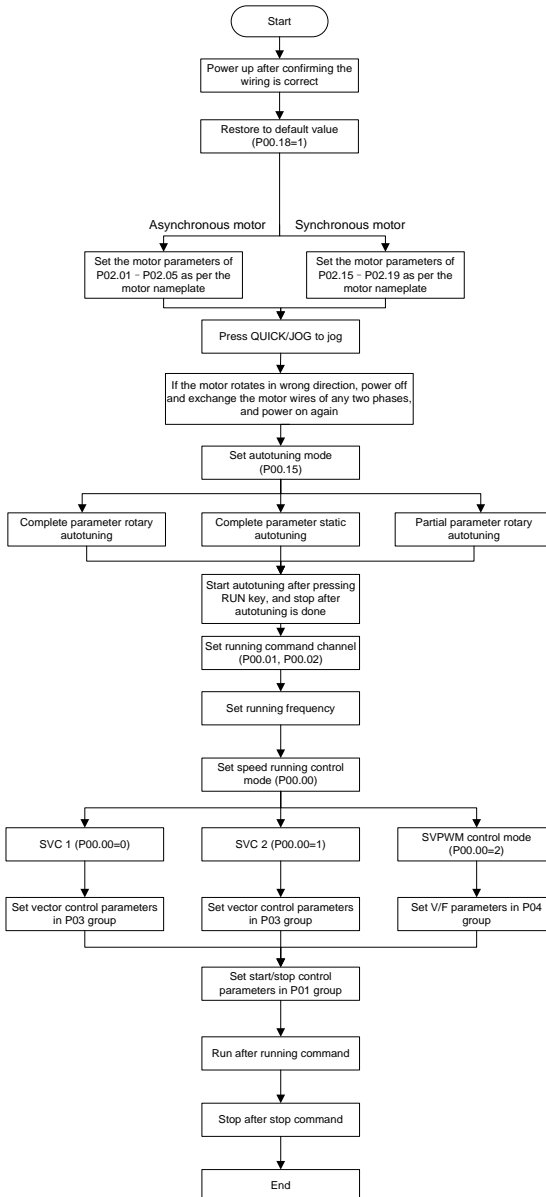

Note: If fault occurred, rule out the fault cause according to "fault tracking".

The running command channel can be set by terminal commands besides P00.01 and P00.02.

Current running command channel P00.01	Multi-function terminal function (36) Command switches to keypad	Multi-function terminal function (37) Command switches to terminal	Multi-function terminal function (38) Command switches to communication
Keypad	/	Terminal	Communication
Terminal	Keypad	/	Communication
Communication	Keypad	Terminal	/

Note: "/" means this multi-function terminal is valid under current reference channel.

Related parameter list:

Function code	Name	Detailed parameter description	Default value
P00.00	Speed control mode	0: SVC 0 1: SVC 1 2: SVPWM 3: VC Note: If 0, 1 or 3 is selected, it is required to carry out motor parameter autotuning first.	2
P00.01	Running command channel	0: Keypad 1: Terminal 2: Communication	0
P00.02	Communication running command channel	0: Modbus 1: PROFIBUS/CANopen/DeviceNet 2: Ethernet 3: EtherCAT/PROFINET 4: PLC programmable card 5: Bluetooth card	0
P00.15	Motor parameter autotuning	0: No operation 1: Rotary autotuning 1; carry out comprehensive motor parameter autotuning; rotary autotuning is used in cases where high control precision is required; 2: Static autotuning 1 (comprehensive autotuning); static autotuning 1 is used in cases where the motor cannot be disconnected from load;	0

Function code	Name	Detailed parameter description	Default value
		<p>3: Static autotuning 2 (partial autotuning) ; when current motor is motor 1, only P02.06, P02.07 and P02.08 will be autotuned; when current motor is motor 2, only P12.06, P12.07 and P12.08 will be autotuned.</p> <p>4: Rotary autotuning 2, which is similar to rotary autotuning 1 but is only applicable to asynchronous motors.</p> <p>5: Rotary autotuning 3 (partial autotuning), which is only applicable to asynchronous motors.</p>	
P00.18	Function parameter restoration	<p>0: No operation</p> <p>1: Restore to default value</p> <p>2: Clear fault history</p> <p>Note: After the selected function operations are done, this function code will be restored to 0 automatically. Restoration to default value will clear the user password, this function should be used with caution.</p>	0
P02.00	Type of motor 1	<p>0: Asynchronous motor</p> <p>1: Synchronous motor</p>	0
P02.01	Rated power of asynchronous motor 1	0.1–3000.0kW	Depends on model
P02.02	Rated frequency of asynchronous motor 1	0.01Hz–P00.03 (max. output frequency)	50.00Hz
P02.03	Rated speed of asynchronous motor 1	1–60000rpm	Depends on model
P02.04	Rated voltage of asynchronous motor 1	0–1200V	Depends on model
P02.05	Rated current of asynchronous motor 1	0.8–6000.0A	Depends on model
P02.15	Rated power of synchronous motor 1	0.1–3000.0kW	Depends on model
P02.16	Rated frequency of synchronous motor 1	0.01Hz–P00.03 (max. output frequency)	50.00Hz
P02.17	Number of pole pairs of synchronous motor 1	1–50	2

Function code	Name	Detailed parameter description	Default value
P02.18	Rated voltage of synchronous motor 1	0–1200V	Depends on model
P02.19	Rated current of synchronous motor 1	0.8–6000.0A	Depends on model
P05.01–P05.06	Function of multi-function digital input terminal (S1–S4, HDIA, HDIB)	36: Command switches to keypad 37: Command switches to terminal 38: Command switches to communication	/
P07.01	Reserved variables	/	/
P07.02	<u>QUICK/JOG</u> key function	Range: 0x00–0x27 Ones: QUICK/JOG key function selection 0: No function 1: Jogging 2: Reserved 3: Switching between forward/reverse rotation 4: Clear UP/DOWN setting 5: Coast to stop 6: Switch running command reference mode by sequence 7: Reserved Tens: Reserved	0x01

5.5.3 Vector control

Asynchronous motors are featured with high order, non-linear, strong coupling and multi-variables, which makes it very difficult to control asynchronous motors during actual application. The vector control theory aims to solve this problem through measuring and controlling the stator current vector of asynchronous motor, and decomposing the stator current vector into exciting current (current component which generates internal magnet field) and torque current (current component which generates torque) based on field orientation principle, and then controlling the amplitude value and phase position of these two components (namely, control the stator current vector of motor) to realize decoupling control of exciting current and torque current, thus achieving high-performance speed regulation of asynchronous motor.

The GD350 IP54 series VFD carries built-in speed sensor-less vector control algorithm, which can be used to drive the asynchronous motor and permanent-magnet synchronous motor simultaneously. As the core algorithm of vector control is based on accurate motor parameter model, the accuracy of motor parameters will impact the control performance of vector control. It is recommended to input accurate motor parameters and carry out motor parameter autotuning before vector operation.

As vector control algorithm is complicated, users should be cautious of regulation on dedicated function parameters of vector control.

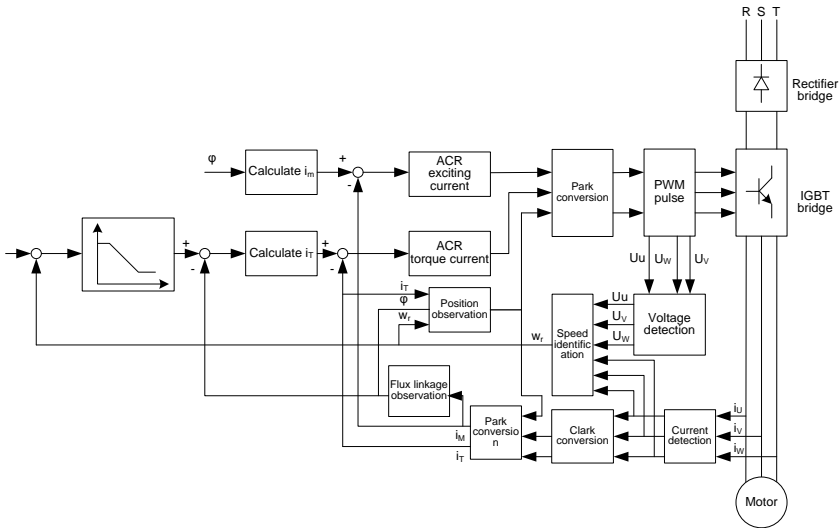

Function code	Name	Description	Default value
P00.00	Speed control mode	0: SVC 0 1: SVC 1 2: SVPWM 3: VC Note: If 0, 1 or 3 is selected, it is required to carry out motor parameter autotuning first.	2
P00.15	Motor parameter autotuning	0: No operation 1: Rotary autotuning 1; carry out comprehensive motor parameter autotuning; rotary autotuning is used in cases where high control precision is required; 2: Static autotuning 1 (comprehensive autotuning); static autotuning 1 is used in cases where the motor cannot be disconnected from load; 3: Static autotuning 2 (partial autotuning) ;	0

Function code	Name	Description	Default value
		when current motor is motor 1, only P02.06, P02.07 and P02.08 will be autotuned; when current motor is motor 2, only P12.06, P12.07 and P12.08 will be autotuned. 4: Rotary autotuning 2, which is similar to rotary autotuning 1 but is only applicable to asynchronous motors. 5: Rotary autotuning 3 (partial autotuning), which is only applicable to asynchronous motors.	
P02.00	Type of motor 1	0: Asynchronous motor 1: Synchronous motor	0
P03.00	Speed loop proportional gain 1	0–200.0	20.0
P03.01	Speed loop integral time 1	0.000–10.000s	0.200s
P03.02	Switching low point frequency	0.00Hz–P03.05	5.00Hz
P03.03	Speed loop proportional gain 2	0–200.0	20.0
P03.04	Speed loop integral time 2	0.000–10.000s	0.200s
P03.05	Switching high point frequency	P03.02–P00.03 (max. output frequency)	10.00Hz
P03.06	Speed loop output filter	0–8 (corresponds to $0-2^8/10\text{ms}$)	0
P03.07	Electromotion slip compensation coefficient of vector control	50%–200%	100%
P03.08	Brake slip compensation coefficient of vector control	50%–200%	100%
P03.09	Current loop proportional coefficient P	0–65535	1000
P03.10	Current loop integral coefficient I	0–65535	1000
P03.32	Torque control enable	0:Disable 1:Enable	0
P03.11	Torque setup mode selection	1: Keypad (P03.12) 2: AI1	1

Function code	Name	Description	Default value
		3: AI2 4: AI3 5: Pulse frequency HDIA 6: Multi-step torque 7: Modbus communication 8: PROFIBUS/CANopen/DeviceNet communication 9: Ethernet communication 10: Pulse frequency HDIB 11: EtherCAT/PROFINET communication 12: PLC Note: For setting sources 2–6 and 10, 100% corresponds to three times the rated motor current.	
P03.12	Torque set by keypad	-300.0%–300.0% (rated motor current)	50.0%
P03.13	Torque reference filter time	0.000–10.000s	0.010s
P03.14	Source of upper limit frequency setup of forward rotation in torque control	0: Keypad (P03.16) 1: AI1 (100% corresponds to max. frequency) 2: AI2 (the same as above) 3: AI3 (the same as above) 4: Pulse frequency HDIA (the same as above) 5: Multi-step (the same as above) 6: Modbus communication (the same as above) 7: PROFIBUS/CANopen/DeviceNet communication (the same as above) 8: Ethernet communication (the same as above) 9: Pulse frequency HDIB (the same as above) 10: EtherCAT/PROFINET communication 11: PLC 12: Reserved Note: Source 1-11, 100% relative to the max. frequency.	0
P03.15	Source of upper limit frequency setup of reverse rotation in torque control	0: Keypad (P03.17) 1–11: the same as P03.14	0

Function code	Name	Description	Default value
P03.16	Keypad limit value of upper limit frequency of forward rotation in torque control	Value range: 0.00 Hz–P00.03 (max. output frequency)	50.00Hz
P03.17	Keypad limit value of upper limit frequency of reverse rotation in torque control		50.00Hz
P03.18	Source of upper limit setup of the torque when motoring	0: Keypad (P03.20) 1: AI1 2: AI2 3: AI3 4: Pulse frequency HDIA 5: Modbus communication 6: PROFIBUS/CANopen/DeviceNet communication 7: Ethernet communication 8: Pulse frequency HDIB 9: EtherCAT/PROFINET communication 10: PLC 11: Reserved Note: For setting sources 1–4 and 8, 100% corresponds to three times the rated motor current.	0
P03.19	Source of upper limit setup of brake torque	0: Keypad (P03.21) 1–10: the same as P03.18	0
P03.20	Set upper limit of the torque when motoring via keypad	0.0–300.0% (rated motor current)	180.0%
P03.21	Set upper limit of brake torque via keypad		180.0%
P03.22	Flux-weakening coefficient in constant power area	0.1–2.0	0.3
P03.23	Min. flux-weakening point in constant power area	10%–100%	20%
P03.24	Max. voltage limit	0.0–120.0%	100.0%
P03.25	Pre-exciting time	0.000–10.000s	0.300s
P03.32	Torque control enable	0:Disable 1:Enable	0
P03.33	Flux weakening integral gain	0–8000	1200

Function code	Name	Description	Default value
P03.35	Control optimization setting	0-0x1111 Ones place: Torque command selection 0: Torque reference 1: Torque current reference Tens place: Reserved 0: Reserved 1: Reserved Hundreds place: Whether to enable ASR integral separation 0: Disable 1: Enable Thousands place: Reserved 0: Reserved 1: Reserved	0x0000
P03.36	ASR differential gain	0.00-10.00s	0.00s
P03.37	High-frequency ACR proportional coefficient	In the closed-loop vector control mode (P00.00=3), when the frequency is lower than the ACR high-frequency switching threshold (P03.39), the ACR PI parameters are P03.09 and P03.10; and when the frequency is higher than the ACR high-frequency switching threshold (P03.39), the ACR PI parameters are P03.37 and P03.38. Setting range of P03.37: 0-65535 Setting range of P03.38: 0-65535 Setting range of P03.39: 0.0-100.0% (in relative to the maximum frequency)	1000
P03.38	High-frequency ACR integral coefficient		1000
P03.39	ACR high-frequency switching threshold		100.0%
P17.32	Flux linkage	0.0-200.0%	0.0%

5.5.4 SVPWM control mode

The GD350 IP54 series VFD also carries built-in SVPWM control function. SVPWM mode can be used in cases where mediocre control precision is enough. In cases where a VFD needs to drive multiple motors, it is also recommended to adopt SVPWM control mode.

The GD350 IP54 series VFD provides multiple kinds of V/F curve modes to meet different field needs. Users can select corresponding V/F curve or set the V/F curve as needed.

Suggestions:

1. For the load featuring constant moment, eg, conveyor belt which runs in straight line, as the moment should be constant during the whole running process, it is recommended to adopt straight-type V/F curve.
2. For the load featuring decreasing moment, eg, fan and water pump, as the relation between its actual torque and speed is squared or cubed, it is recommended to adopt the V/F curve corresponds to power 1.3, 1.7 or 2.0.

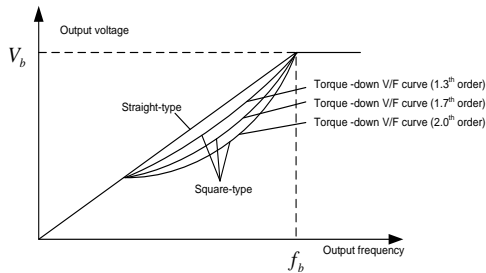

The GD350 IP54 series VFD also provides multi-point V/F curve. Users can alter the V/F curve outputted by VFD through setting the voltage and frequency of the three points in the middle. The whole curve consists of five points starting from (0Hz, 0V) and ending in (fundamental motor frequency, rated motor voltage). During setup, it is required that $0 \leq f_1 \leq f_2 \leq f_3 \leq \text{fundamental motor frequency}$, and $0 \leq V_1 \leq V_2 \leq V_3 \leq \text{rated motor voltage}$

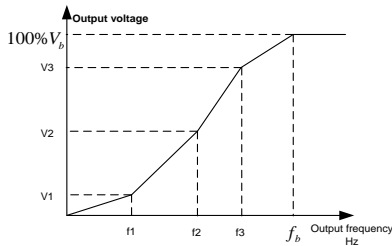

The GD350 IP54 series VFD provides dedicated function codes for SVPWM control mode. Users can improve the performance of SVPWM through settings.

1. Torque boost

Torque boost function can effectively compensate for the low-speed torque performance during SVPWM control. Automatic torque boost has been set by default to enable the VFD to adjust the torque boost value based on actual load conditions.

Note:

- (1) Torque boost is effective only under torque boost cut-off frequency;

- (2) If the torque boost is too large, low-frequency vibration or overcurrent may occur to the motor, if such situation occurs, lower the torque boost value.

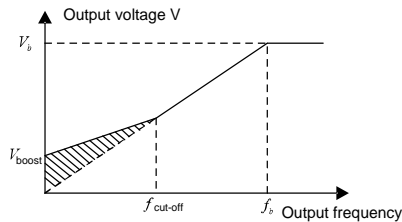

2. Energy-saving run

During actual running, the VFD can search for the max. efficiency point to keep running in the most efficient state to save energy.

Note:

- (1) This function is generally used in light load or no-load cases.
- (2) This function does for fit in cases where load transient is required.

3. V/F slip compensation gain

SVPWM control belongs to open-loop mode, which will cause motor speed to fluctuate when motor load transients. In cases where strict speed requirement is needed, users can set the slip compensation gain to compensate for the speed variation caused by load fluctuation through internal output adjustment of VFD.

The set range of slip compensation gain is 0–200%, in which 100% corresponds to rated slip frequency.

Note: Rated slip frequency = (rated synchronous speed of motor - rated speed of motor) × number of motor pole pairs / 60

4. Oscillation control

Motor oscillation often occurs in SVPWM control in large-power drive applications. To solve this problem, the GD350 IP54 series VFD sets two function codes to control the oscillation factor, and users can set the corresponding function code based on the occurrence frequency of oscillation.

Note: The larger the set value, the better the control effect, however, if the set value is too large, it may easily lead to too large VFD output current.

Customized V/F curve (V/F separation) function:

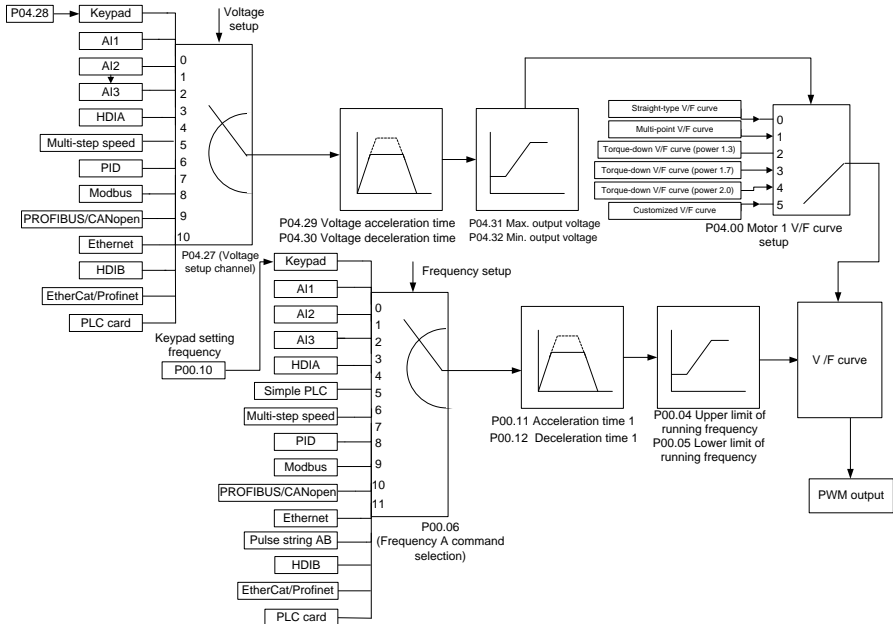

When selecting customized V/F curve function, users can set the reference channels and acceleration/deceleration time of voltage and frequency respectively, which will form a real-time V/F curve through combination.

Note: This kind of V/F curve separation can be applied in various frequency-conversion power sources, however, users should be cautious of parameter setup as improper setup may damage the machine.

Function code	Name	Detailed parameter description	Default value
P00.00	Speed control mode	0: SVC 0 1: SVC 1 2: SVPWM 3: VC Note: If 0, 1 or 3 is selected, it is required to carry out motor parameter autotuning first.	2
P00.03	Max. output frequency	P00.04–400.00Hz	50.00Hz
P00.04	Upper limit of running frequency	P00.05–P00.03	50.00Hz
P00.05	Lower limit of running frequency	0.00Hz–P00.04	0.00Hz

Function code	Name	Detailed parameter description	Default value
P00.11	Acceleration time 1	0.0–3600.0s	Depends on model
P00.12	Deceleration time 1	0.0–3600.0s	Depends on model
P02.00	Type of motor 1	0: Asynchronous motor 1: Synchronous motor	0
P02.02	Rated power of asynchronous motor 1	0.01Hz–P00.03 (max. output frequency)	50.00Hz
P02.04	Rated voltage of asynchronous motor 1	0–1200V	Depends on model
P04.00	V/F curve setting of motor 1	0: Straight-type V/F curve 1: Multi-point V/F curve 2: Torque-down V/F curve (power 1.3) 3: Torque-down V/F curve (power 1.7) 4: Torque-down V/F curve (power 2.0) 5: Customized V/F (V/F separation)	0
P04.01	Torque boost of motor 1	0.0%: (automatic) 0.1%–10.0%	0.0%
P04.02	Motor 1 torque boost cut-off	0.0%–50.0% (rated frequency of motor 1)	20.0%
P04.03	V/F frequency point 1 of motor 1	0.00Hz–P04.05	0.00Hz
P04.04	V/F voltage point 1 of motor 1	0.0%–110.0%	0.0%
P04.05	V/F frequency point 2 of motor 1	P04.03– P04.07	0.00Hz
P04.06	V/F voltage point 2 of motor 1	0.0%–110.0%	0.0%
P04.07	V/F frequency point 3 of motor 1	P04.05– P02.02 or P04.05– P02.16	0.00Hz
P04.08	V/F voltage point 3 of motor 1	0.0%–110.0%	0.0%
P04.09	V/F slip compensation gain of motor 1	0.0–200.0%	100.0%
P04.10	Low-frequency oscillation control factor of motor 1	0–100	10
P04.11	High-frequency oscillation control factor of motor 1	0–100	10
P04.12	Oscillation control threshold of motor 1	0.00Hz–P00.03 (max. output frequency)	30.00Hz
P04.13	V/F curve setup of motor 2	0: Straight V/F curve; 1: Multi-point V/F curve	0

Function code	Name	Detailed parameter description	Default value
		2: Torque-down V/F curve (1.3 th order) 3: Torque-down V/F curve (1.7 th order) 4: Torque-down V/F curve (2.0 th order) 5: Customize V/F (V/F separation)	
P04.14	Torque boost of motor 2	0.0%: (automatic) 0.1%–10.0%	0.0%
P04.15	Motor 2 torque boost cut-off	0.0%–50.0% (rated frequency of motor 1)	20.0%
P04.16	V/F frequency point 1 of motor 2	0.00Hz–P04.18	0.00Hz
P04.17	V/F voltage point 1 of motor 2	0.0%–110.0%	0.0%
P04.18	V/F frequency point 2 of motor 2	P04.16– P04.20	0.00Hz
P04.19	V/F voltage point 2 of motor 2	0.0%–110.0%	0.0%
P04.20	V/F frequency point 3 of motor 2	P04.18– P02.02 or P04.18– P02.16	0.00Hz
P04.21	V/F voltage point 3 of motor 2	0.0%–110.0%	0.0%
P04.22	V/F slip compensation gain of motor 2	0.0–200.0%	100.0%
P04.23	Low-frequency oscillation control factor of motor 2	0–100	10
P04.24	High-frequency oscillation control factor of motor 2	0–100	10
P04.25	Oscillation control threshold of motor 2	0.00Hz–P00.03 (max. output frequency)	30.00Hz
P04.26	Energy-saving run	0: No 1: Automatic energy-saving run	0
P04.27	Channel of voltage setup	0: Keypad; output voltage is determined by P04.28 1: AI1 2: AI2 3: AI3 4: HDIA 5: Multi-step 6: PID 7: Modbus communication 8: PROFIBUS/CANopen communication 9: Ethernet communication 10: HDIB	0

Function code	Name	Detailed parameter description	Default value
		11: EtherCAT/PROFINET communication 12: PLC card 13: Reserved	
P04.28	Set voltage value via keypad	0.0%–100.0% (rated motor voltage)	100.0%
P04.29	Voltage acceleration time	0.0–3600.0s	5.0s
P04.30	Voltage deceleration time	0.0–3600.0s	5.0s
P04.31	Max. output voltage	P04.32–100.0% (rated motor voltage)	100.0%
P04.32	Min. output voltage	0.0%–P04.31 (rated motor voltage)	0.0%

5.5.5 Torque control

The GD350 IP54 series VFD supports torque control and speed control. Speed control mode aims to stabilize the speed to keep the set speed consistent with the actual running speed, meanwhile, the max. load-carrying capacity is restricted by torque limit. Torque control mode aims to stabilize the torque to keep the set torque consistent with the actual output torque, meanwhile, the output frequency is restricted by upper/lower limit.

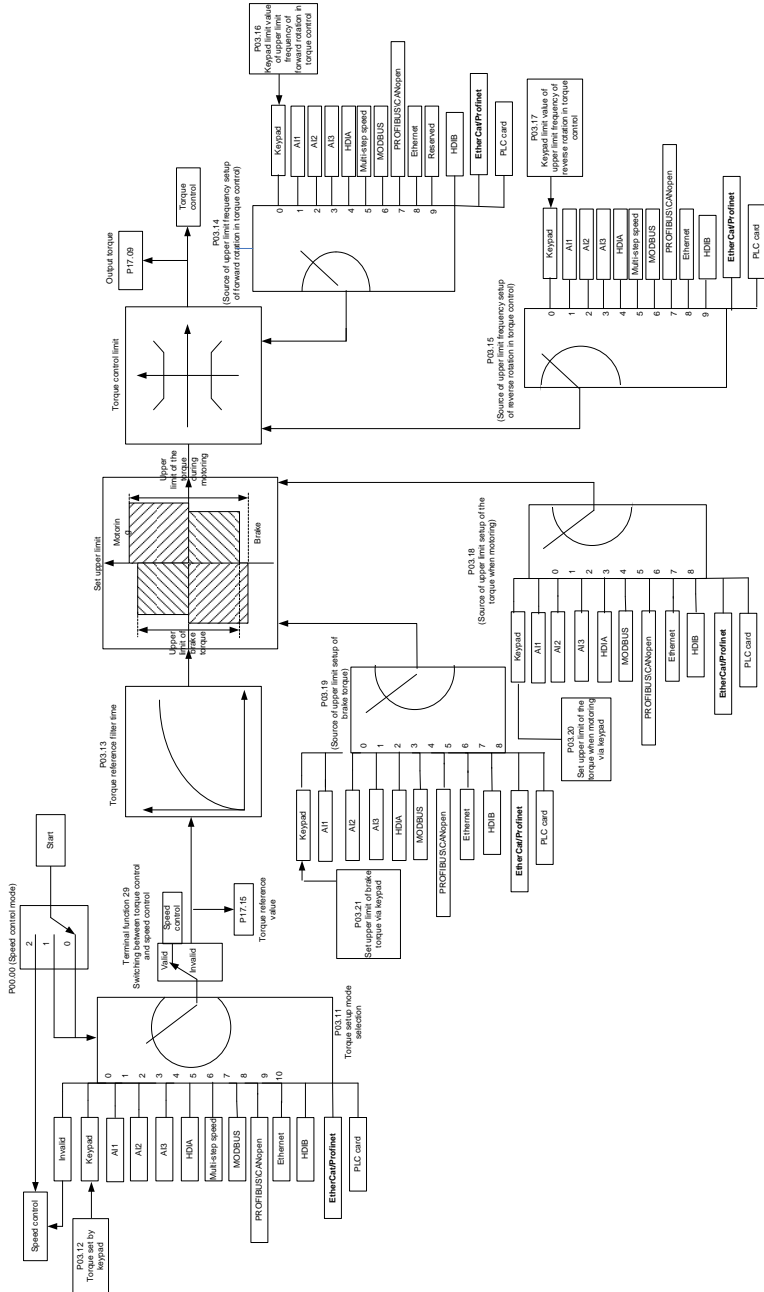



Function code	Name	Detailed parameter description	Default value
P00.00	Speed control mode	0: SVC 0 1: SVC 1 2: SVPWM 3: VC Note: If 0, 1 or 3 is selected, it is required to carry out motor parameter autotuning first.	2
P03.32	Torque control enable	0: Disable 1: Enable	0
P03.11	Torque setup mode selection	1: Keypad (P03.12) 2: AI1 3: AI2 4: AI3 5: Pulse frequency HDIA 6: Multi-step torque 7: Modbus communication 8: PROFIBUS/CANopen/DeviceNet communication 9: Ethernet communication 10: Pulse frequency HDIB 11: EtherCAT/PROFINET communication 12: PLC Note: For setting sources 2–6 and 10, 100% corresponds to three times the rated motor current.	1
P03.12	Torque set by keypad	-300.0%–300.0% (rated motor current)	50.0%
P03.13	Torque reference filter time	0.000–10.000s	0.010s
P03.14	Source of upper limit frequency setup of forward rotation in torque control	0: Keypad (P03.16) 1: AI1 (100% corresponds to max. frequency) 2: AI2 (the same as above) 3: AI3 (the same as above) 4: Pulse frequency HDIA (the same as above) 5: Multi-step (the same as above) 6: Modbus communication (the same as above) 7: PROFIBUS/CANopen/DeviceNet communication (the same as above) 8: Ethernet communication (the same as above)	0

Function code	Name	Detailed parameter description	Default value
		9: Pulse frequency HDIB (the same as above) 10: EtherCAT/PROFINET communication 11: PLC 12: Reserved Note: Source 1-11, 100% relative to the max. frequency	
P03.15	Source of upper limit frequency setup of reverse rotation in torque control	0: Keypad (P03.17) 1: AI1 (100% corresponds to max. frequency) 2: AI2 (the same as above) 3: AI3 (the same as above) 4: Pulse frequency HDIA (the same as above) 5: Multi-step (the same as above) 6: Modbus communication (the same as above) 7: PROFIBUS/CANopen/DeviceNet communication (the same as above) 8: Ethernet communication (the same as above) 9: Pulse frequency HDIB (the same as above) 10: EtherCAT/PROFINET communication 11: PLC 12: Reserved Note: Source 1-11, 100% relative to the max. frequency	0
P03.16	Keypad limit value of upper limit frequency of forward rotation in torque control	0.00Hz–P00.03 (max. output frequency)	50.00 Hz
P03.17	Keypad limit value of upper limit frequency of reverse rotation in torque control	0.00Hz–P00.03 (max. output frequency)	50.00 Hz
P03.18	Source of upper limit setup of the torque during motoring	0: Keypad (P03.20) 1: AI1 2: AI2 3: AI3 4: Pulse frequency HDIA 5: Modbus communication	0

Function code	Name	Detailed parameter description	Default value
		6: PROFIBUS/CANopen/DeviceNet communication 7: Ethernet communication 8: Pulse frequency HDIB 9: EtherCAT/PROFINET communication 10: PLC 11: Reserved Note: For setting sources 1–4 and 8, 100% corresponds to three times the rated motor current.	
P03.19	Source of upper limit setup of brake torque	0: Keypad (P03.21) 1–10: the same as P03.18	0
P03.20	Set upper limit of the torque when motoring via keypad	0.0–300.0% (rated motor current)	180.0%
P03.21	Set upper limit of brake torque via keypad	0.0–300.0% (rated motor current)	180.0%
P17.09	Motor output torque	-250.0–250.0%	0.0%
P17.15	Torque reference value	-300.0–300.0% (rated motor current)	0.0%

5.5.6 Motor parameter

	<ul style="list-style-type: none"> ◇ Check the safety conditions surrounding the motor and load machineries before autotuning as physical injury may occur due to sudden start of motor during autotuning. ◇ Although the motor does not run during static autotuning, the motor is still supplied with power, do not touch the motor during autotuning; otherwise, electric shock may occur.
	<ul style="list-style-type: none"> ◇ If the motor has been connected to load, do not carry out rotary autotuning; otherwise, misact or damage may occur to the VFD. If rotary autotuning is carried out on a motor which has been connected to load, wrong motor parameters and motor misacts may occur. Disconnect the load to carry out autotuning if necessary.

The GD350 IP54 series VFD can drive asynchronous motors and synchronous motors, and it supports two sets of motor parameters, which can be switched over by multi-function digital input terminals or communication modes.

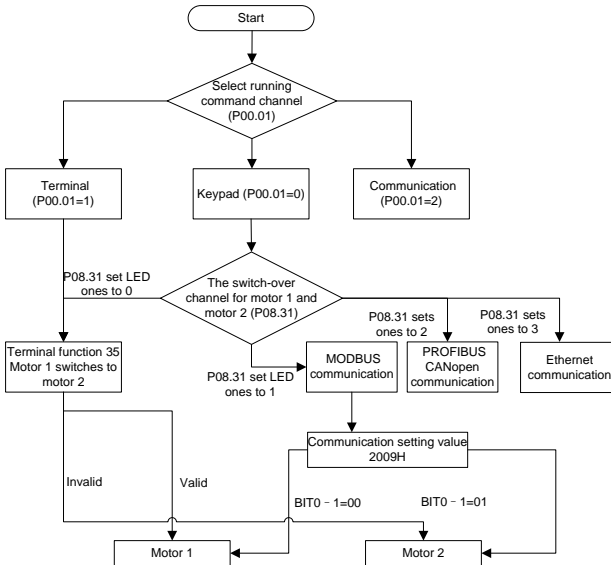

The control performance of the VFD is based on accurate motor model; therefore, users need to carry out motor parameter autotuning before running the motor for the first time (take motor 1 as an example).

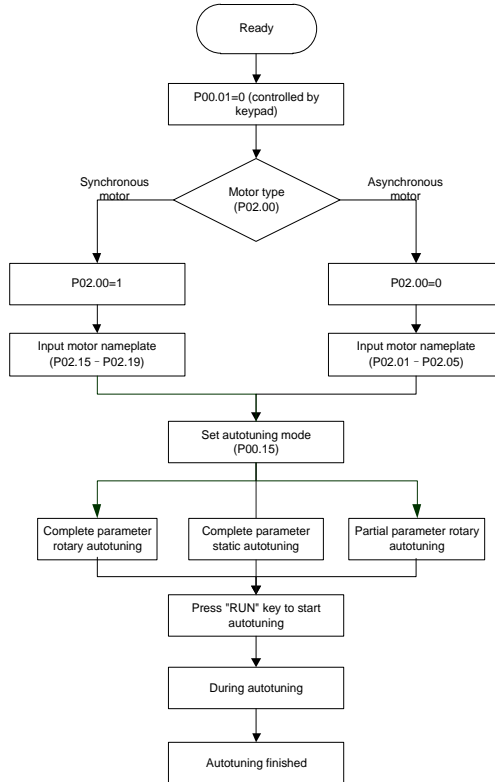

Note:

1. Motor parameters must be set correctly according to motor nameplate;
2. If rotary autotuning is selected during motor autotuning, it is a must to disconnect the motor from load to put the motor in static and no-load state, failed to do so may lead to inaccurate autotuned results. At this time, the asynchronous motor can autotune P02.06–P02.10, and synchronous motor can autotune P02.20–P02.23
3. If static autotuning is selected during motor autotuning, there is no need to disconnect the motor from load, as only part of the motor parameters have been autotuned, the control performance may be impacted, under such situation, the asynchronous motor can autotune P02.06–P02.10, while synchronous motor can autotune P02.20–P02.22, P02.23 (counter-emf constant of synchronous motor 1) can be obtained via calculation.
4. Motor autotuning can be carried out on current motor only, if users need to perform autotuning on the other motor, switch over the motor through selecting the switch-over channel of motor 1 and motor 2 by setting the ones of P08.31.

Related parameter list:

Function code	Name	Detailed parameter description	Default value
P00.01	Running command channel	0: Keypad 1: Terminal 2: Communication	0
P00.15	Motor parameter autotuning	0: No operation 1: Rotary autotuning 1; carry out comprehensive motor parameter autotuning; rotary autotuning is used in cases where high control precision is required; 2: Static autotuning 1 (comprehensive autotuning); static autotuning 1 is used in cases where the motor cannot be disconnected from load; 3: Static autotuning 2 (partial autotuning) ; when current motor is motor 1, only P02.06, P02.07 and P02.08 will be autotuned; when current motor is motor 2, only P12.06, P12.07 and P12.08 will be autotuned. 4: Rotary autotuning 2, which is similar to rotary autotuning 1 but is only applicable to asynchronous motors. 5: Rotary autotuning 3 (partial autotuning), which is only applicable to asynchronous motors.	0
P02.00	Type of motor 1	0: Asynchronous motor 1: Synchronous motor	0
P02.01	Rated power of asynchronous motor 1	0.1–3000.0kW	Depends on model
P02.02	Rated frequency of asynchronous motor 1	0.01Hz–P00.03 (max. output frequency)	50.00Hz
P02.03	Rated speed of asynchronous motor 1	1–60000rpm	Depends on model
P02.04	Rated voltage of asynchronous motor 1	0–1200V	Depends on model
P02.05	Rated current of asynchronous motor 1	0.8–6000.0A	Depends on model

Function code	Name	Detailed parameter description	Default value
P02.06	Stator resistance of asynchronous motor 1	0.001–65.535Ω	Depends on model
P02.07	Rotor resistance of asynchronous motor 1	0.001–65.535Ω	Depends on model
P02.08	Leakage inductance of asynchronous motor 1	0.1–6553.5mH	Depends on model
P02.09	Mutual inductance of asynchronous motor 1	0.1–6553.5mH	Depends on model
P02.10	No-load current of asynchronous motor 1	0.1–6553.5A	Depends on model
P02.15	Rated power of synchronous motor 1	0.1–3000.0kW	Depends on model
P02.16	Rated frequency of synchronous motor 1	0.01Hz–P00.03 (max. output frequency)	50.00Hz
P02.17	Number of pole pairs of synchronous motor 1	1–50	2
P02.18	Rated voltage of synchronous motor 1	0–1200V	Depends on model
P02.19	Rated current of synchronous motor 1	0.8–6000.0A	Depends on model
P02.20	Stator resistance of synchronous motor 1	0.001–65.535Ω	Depends on model
P02.21	Direct-axis inductance of synchronous motor 1	0.01–655.35mH	Depends on model
P02.22	Quadrature-axis inductance of synchronous motor 1	0.01–655.35mH	Depends on model
P02.23	Counter-emf constant of synchronous motor 1	0–10000	300
P05.01–P05.06	Function of multi-function digital input terminal (S1–S4, HDIA, HDIB)	35: Motor 1 switches to motor 2	/
P08.31	Switching between motor 1 and motor 2	0x00–0x14 Ones: Switch-over channel 0: Switch over by terminal 1: Switch over by Modbus communication 2: Switch over by	00

Function code	Name	Detailed parameter description	Default value
		PROFIBUS/CANopen/DeviceNet 3: Switch over by Ethernet communication 4: Switch over by EtherCAT/PROFINET communication Tens: Motor switch-over during running 0: Disable switch-over during running 1: Enable switch-over during running	
P12.00	Type of motor 2	0: Asynchronous motor 1: Synchronous motor	0
P12.01	Rated power of asynchronous motor 2	0.1–3000.0kW	Depends on model
P12.02	Rated frequency of asynchronous motor 2	0.01Hz–P00.03 (max. output frequency)	50.00Hz
P12.03	Rated speed of asynchronous motor 2	1–36000rpm	Depends on model
P12.04	Rated voltage of asynchronous motor 2	0–1200V	
P12.05	Rated current of asynchronous motor 2	0.8–6000.0A	
P12.06	Stator resistance of asynchronous motor 2	0.001–65.535Ω	
P12.07	Rotor resistance of asynchronous motor 2	0.001–65.535Ω	
P12.08	Leakage inductance of asynchronous motor 2	0.1–6553.5mH	
P12.09	Mutual inductance of asynchronous motor 2	0.1–6553.5mH	
P12.10	No-load current of asynchronous motor 2	0.1–6553.5A	
P12.15	Rated power of synchronous motor 2	0.1–3000.0kW	
P12.16	Rated frequency of synchronous motor 2	0.01Hz–P00.03 (max. output frequency)	
P12.17	Number of pole pairs of synchronous motor 2	1–50	2
P12.18	Rated voltage of synchronous motor 2	0–1200V	Depends on model

Function code	Name	Detailed parameter description	Default value
P12.19	Rated current of synchronous motor 2	0.8–6000.0A	Depends on model
P12.20	Stator resistance of synchronous motor 2	0.001–65.535Ω	Depends on model
P12.21	Direct-axis inductance of synchronous motor 2	0.01–655.35mH	Depends on model
P12.22	Quadrature-axis inductance of synchronous motor 2	0.01–655.35mH	Depends on model
P12.23	Counter-emf constant of synchronous motor 2	0–10000	300

5.5.7 Start/stop control

The start/stop control of the VFD is divided into three states: start after running command at power-up; start after restart-at-power-cut function is effective; start after automatic fault reset. Descriptions for these three start/stop control states are presented below.

There are three start modes for the VFD, which are start at starting frequency, start after DC brake, and start after speed-tracking. Users can select the proper start mode based on field conditions.

For large-inertia load, especially in cases where reversal may occur, users can choose to start after DC brake or start after speed-racking.

Note: It is recommended to drive synchronous motors in direct start mode.

1. Logic diagram for running command after power-up

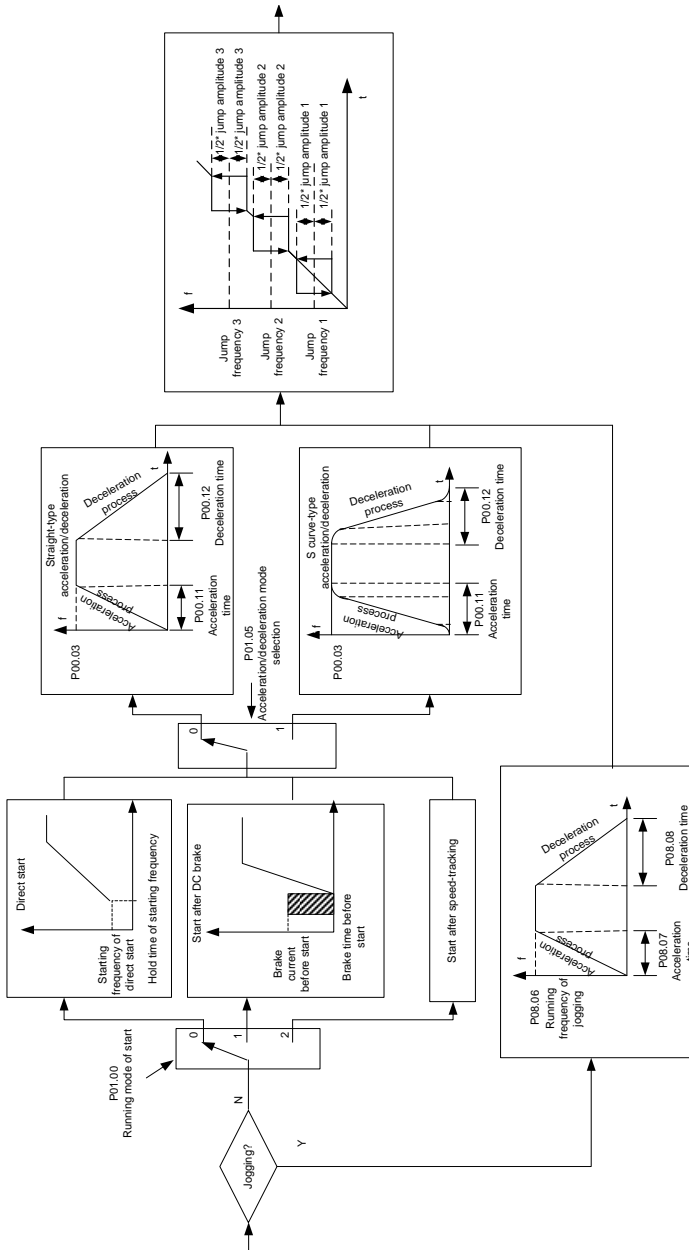

2. Logic diagram for restart after power-cut

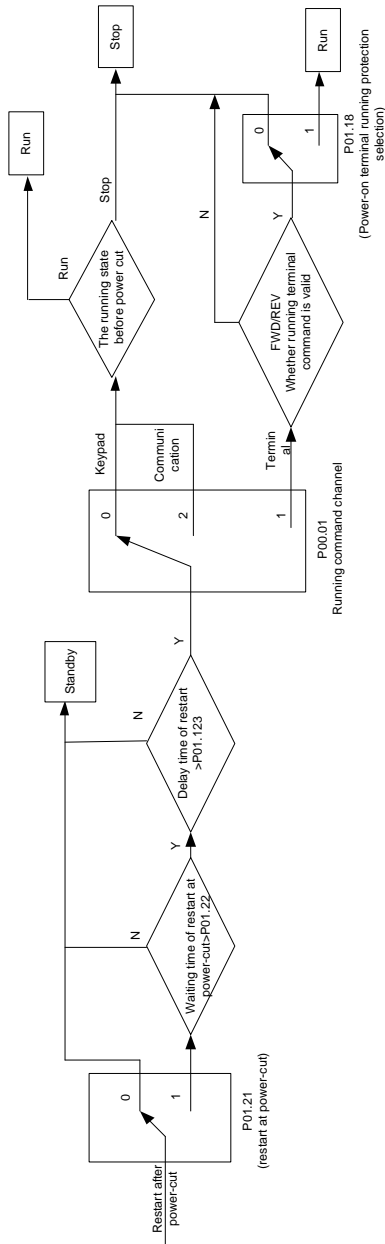

3. Logic diagram for restart after automatic fault reset

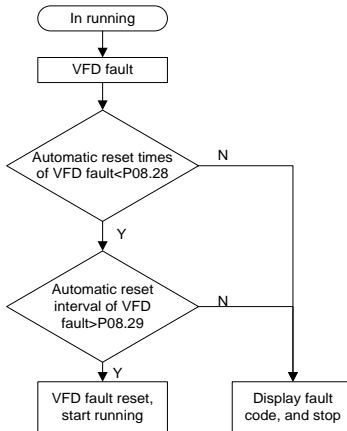

Related parameter list:

Function code	Name	Detailed parameter description	Default value
P00.01	Running command channel	0: Keypad 1: Terminal 2: Communication	0
P00.11	Acceleration time 1	0.0–3600.0s	Depends on model
P00.12	Deceleration time 1	0.0–3600.0s	Depends on model
P01.00	Running mode of start	0: Direct start 1: Start after DC brake 2: Start after speed-track 1 3: Start after speed-track 2	0
P01.01	Starting frequency of direct start	0.00–50.00Hz	0.50Hz
P01.02	Hold time of starting frequency	0.0–50.0s	0.0s
P01.03	DC brake current before start	0.0–100.0%	0.0%
P01.04	DC brake time before start	0.00–50.00s	0.00s
P01.05	Acceleration/deceleration mode	0: Straight line 1: S curve Note: If mode 1 is selected, it is required to set P01.07, P01.27 and P01.08 accordingly	0

Function code	Name	Detailed parameter description	Default value
P01.08	Stop mode	0: Decelerate to stop 1: Coast to stop	0
P01.09	Starting frequency of DC brake after stop	0.00Hz–P00.03 (max. output frequency)	0.00Hz
P01.10	Waiting time of DC brake after stop	0.00–50.00s	0.00s
P01.11	DC brake current of stop	0.0–100.0%	0.0%
P01.12	DC brake time of stop	0.00–50.00s	0.00s
P01.13	Deadzone time of forward/reverse rotation	0.0–3600.0s	0.0s
P01.14	Forward/reverse rotation switch-over mode	0: switch over after zero frequency 1: switch over after starting frequency 2: switch over after passing stop speed and delay	0
P01.15	Stop speed	0.00–100.00Hz	0.50 Hz
P01.16	Stop speed detection mode	0: Set value of speed (the only detection mode valid in SVPWM mode) 1: Detection value of speed	1
P01.18	Power-on terminal running protection selection	0: Terminal running command is invalid at power up 1: Terminal running command is valid at power up	0
P01.19	Action selection when the running frequency is below lower limit (lower limit should be larger than 0)	0: Run at the lower limit frequency 1: Stop 2: Sleep	0
P01.20	Wake-up-from-sleep delay	0.0–3600.0s (valid when P01.19 is 2)	0.0s
P01.21	Restart after power cut	0: Restart is disabled 1: Restart is enabled	0
P01.22	Waiting time of restart after power cut	0.0–3600.0s (valid when P01.21 is 1)	1.0s
P01.23	Start delay	0.0–60.0s	0.0s
P01.24	Stop speed delay	0.0–100.0s	0.0s
P01.25	Open-loop 0Hz output selection	0: No voltage output 1: With voltage output 2: Output as per DC brake current of stop	0

Function code	Name	Detailed parameter description	Default value
P01.26	Deceleration time of emergency-stop	0.0–60.0s	2.0s
P01.27	Time of starting section of deceleration S curve	0.0–50.0s	0.1s
P01.28	Time of ending section of deceleration S curve	0.0–50.0s	0.1s
P01.29	Short-circuit brake current	0.0–150.0% (rated VFD current)	0.0%
P01.30	Hold time of short-circuit brake at startup	0.00–50.00s	0.00s
P01.31	Hold time of short-circuit brake at stop	0.00–50.00s	0.00s
P01.32	Pre-exciting time of jogging	0–10.000s	0.000s
P01.33	Starting frequency of braking for jogging to stop	0–P00.03	0.00Hz
P01.34	Delay to enter sleep	0–3600.0s	0.0s
P05.01–P05.06	Digital input function selection	1: Forward running 2: Reverse running 4: Forward jogging 5: Reverse jogging 6: Coast to stop 7: Fault reset 8: Running pause 21: Acceleration/deceleration time selection 1 22: Acceleration/deceleration time selection 2 30: Acceleration/deceleration disabled	/
P08.06	Running frequency of jog	0.00Hz–P00.03 (max. output frequency)	5.00Hz
P08.07	Acceleration time at jogging	0.0–3600.0s	Depends on model
P08.08	Deceleration time at jogging	0.0–3600.0s	Depends on model
P08.00	Acceleration time 2	0.0–3600.0s	Depends on model
P08.01	Declaration time 2	0.0–3600.0s	Depends on model

Function code	Name	Detailed parameter description	Default value
P08.02	Acceleration time 3	0.0–3600.0s	Depends on model
P08.03	Declaration time 3	0.0–3600.0s	Depends on model
P08.04	Acceleration time 4	0.0–3600.0s	Depends on model
P08.05	Declaration time 4	0.0–3600.0s	Depends on model
P08.19	Switching frequency of acceleration/deceleration time	0.00–P00.03 (max. output frequency) 0.00Hz: No switch over If the running frequency is larger than P08.19, switch to acceleration /deceleration time 2	0
P08.21	Reference frequency of acceleration/deceleration time	0: Max. output frequency 1: Set frequency 2: 100Hz Note: Valid for straight-line acceleration/deceleration only	0
P08.28	Automatic fault reset times	0–10	0
P08.29	Automatic fault reset time interval	0.1–3600.0s	1.0s

5.5.8 Frequency setup

The GD350 IP54 series VFD supports multiple kinds of frequency reference modes, which can be categorized into two types: main reference channel and auxiliary reference channel.

There are two main reference channels, namely frequency reference channel A and frequency reference channel B. These two channels support simple arithmetical operation between each other, and they can be switched dynamically by setting multi-function terminals.

There is one input mode for auxiliary reference channel, namely terminal UP/DOWN switch input. By setting function codes, users can enable the corresponding reference mode and the impact made on the VFD frequency reference by this reference mode.

The actual reference of VFD is comprised of the main reference channel and auxiliary reference channel.

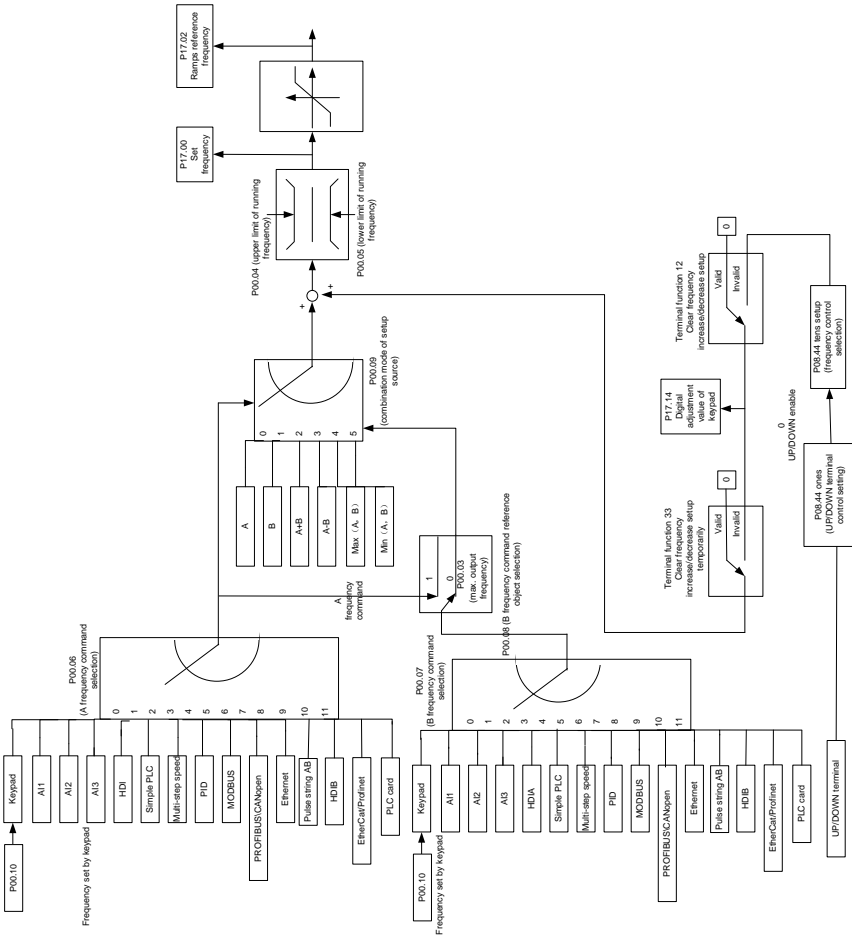

The GD350 IP54 series VFD supports switch-over between different reference channels, and the rules for channel switch-over are shown below.

Present reference channel P00.09	Multi-function terminal function 13 Channel A switches to channel B	Multi-function terminal function 14 Combination setup switches to channel A	Multi-function terminal function 15 Combination setup switches to channel B
A	B	/	/
B	A	/	/
A+B	/	A	B

Present reference channel P00.09	Multi-function terminal function 13 Channel A switches to channel B	Multi-function terminal function 14 Combination setup switches to channel A	Multi-function terminal function 15 Combination setup switches to channel B
A-B	/	A	B
Max (A, B)	/	A	B
Min (A, B)	/	A	B

Note: "/" indicates this multi-function terminal is invalid under present reference channel.

When setting the auxiliary frequency inside the VFD via multi-function terminal UP (10) and DOWN (11), users can increase/decrease the frequency quickly by setting P08.45 (UP terminal frequency incremental change rate) and P08.46 (DOWN terminal frequency decremental change rate).

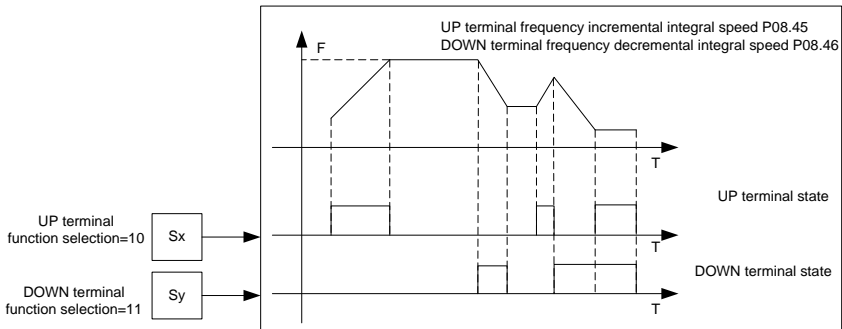

Related parameter list:

Function code	Name	Detailed parameter description	Default value
P00.03	Max. output frequency	P00.04–400.00Hz	50.00Hz
P00.04	Upper limit of running frequency	P00.05–P00.03	50.00Hz
P00.05	Lower limit of running frequency	0.00Hz–P00.04	0.00Hz
P00.06	A frequency command selection	0: Set via keypad 1: Set via AI1	0
P00.07	B frequency command selection	2: Set via AI2 3: Set via AI3 4: Set via high speed pulse HDIA 5: Set via simple PLC program 6: Set via multi-step speed running 7: Set via PID control	15

Function code	Name	Detailed parameter description	Default value
		8: Set via Modbus communication 9: Set via PROFIBUS/CANopen/DeviceNet communication 10: Set via Ethernet communication 11: Set via high speed pulse HDIB 12: Set via pulse string AB 13: Set via EtherCAT/PROFINET communication 14: Set via PLC card 15: Reserved	
P00.08	Reference object of B frequency command	0: Max. output frequency 1: A frequency command	0
P00.09	Combination mode of setup source	0: A 1: B 2: (A+B) 3: (A-B) 4: Max (A, B) 5: Min (A, B)	0
P05.01– P05.06	Function of multi-function digital input terminal (S1–S4, HDIA, HDIB)	10: Frequency increase (UP) 11: Frequency decrease (DOWN) 12: Clear frequency increase/decrease setting 13: Switch-over between setup A and setup B 14: Switch-over between combination setup and setup A 15: Switch-over between combination setup and setup B	/
P08.42	Reserved variables	/	/
P08.43	Reserved variables	/	/
P08.44	UP/DOWN terminal control	0x000–0x221 Ones: Frequency enabling selection 0: UP/DOWN terminal setting is valid 1: UP/DOWN terminal setting is invalid Tens: Frequency control selection 0: Valid only when P00.06=0 or P00.07=0	0x000

Function code	Name	Detailed parameter description	Default value
		1: Valid for all frequency modes 2: Invalid for multi-step speed when multi-step speed takes priority Hundreds: Action selection at stop 0: Valid 1: Valid during running, clear after stop 2: Valid during running, clear after receiving stop command	
P08.45	UP terminal frequency incremental change rate	0.01–50.00 Hz/s	0.50 Hz/s
P08.46	DOWN terminal frequency decremental change rate	0.01–50.00 Hz/s	0.50 Hz/s
P17.00	Set frequency	0.00Hz–P00.03 (max. output frequency)	0.00Hz
P17.02	Ramps reference frequency	0.00Hz–P00.03 (max. output frequency)	0.00Hz
P17.14	Digital adjustment value	0.00Hz–P00.03	0.00Hz

5.5.9 Analog input

GD350 IP54 series VFD carries two analog input terminals (AI1 is 0–10V/0–20mA (voltage input or current input can be set by P05.50); AI2 is -10–10V) and two high-speed pulse input terminals. Each input can be filtered separately, and the corresponding reference curve can be set by adjusting the reference corresponds to the max. value and min. value.

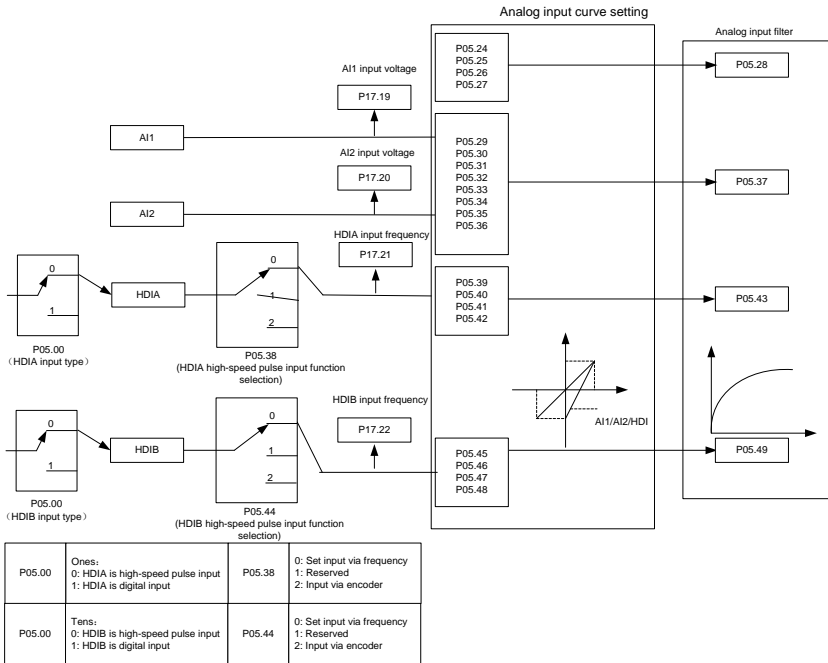

Related parameter list:

Function code	Name	Detailed parameter description	Default value
P05.00	HDI input type	0x00–0x11 Ones: HDIA input type 0: HDIA is high-speed pulse input 1: HDIA is digital input Tens: HDIB input type 0: HDIB is high-speed pulse input 1: HDIB is digital input	0x00
P05.24	Lower limit value of AI1	0.00V–P05.26	0.00V
P05.25	Corresponding setting of lower limit of AI1	-300.0%–300.0%	0.0%
P05.26	Upper limit value of AI1	P05.24–10.00V	10.00V
P05.27	Corresponding setting of upper limit of AI1	-300.0%–300.0%	100.0%
P05.28	Input filter time of AI1	0.000s–10.000s	0.100s

Function code	Name	Detailed parameter description	Default value
P05.29	Lower limit value of AI2	-10.00V~P05.31	-10.00V
P05.30	Corresponding setting of lower limit of AI2	-300.0%~300.0%	-100.0%
P05.31	Intermediate value 1 of AI2	P05.29~P05.33	0.00V
P05.32	Corresponding setting of intermediate value 1 of AI2	-300.0%~300.0%	0.0%
P05.33	Intermediate value 2 of AI2	P05.31~P05.35	0.00V
P05.34	Corresponding setting of intermediate value 2 of AI2	-300.0%~300.0%	0.0%
P05.35	Upper limit value of AI2	P05.33~10.00V	10.00V
P05.36	Corresponding setting of upper limit of AI2	-300.0%~300.0%	100.0%
P05.37	Input filter time of AI2	0.000s~10.000s	0.100s
P05.38	HDIA high-speed pulse input function	0: Set input via frequency 1: Reserved 2: Input via encoder, used in combination with HDIB	0
P05.39	Lower limit frequency of HDIA	0.000 kHz – P05.41	0.000kHz
P05.40	Corresponding setting of lower limit frequency of HDIA	-300.0%~300.0%	0.0%
P05.41	Upper limit frequency of HDIA	P05.39 –50.000kHz	50.000kHz
P05.42	Corresponding setting of upper limit frequency of HDIA	-300.0%~300.0%	100.0%
P05.43	HDIA frequency input filter time	0.000s~10.000s	0.030s
P05.44	HDIB high-speed pulse input function selection	0: Set input via frequency 1: Reserved 2: Input via encoder, used in combination with HDIA	0
P05.45	Lower limit frequency of HDIB	0.000 kHz – P05.47	0.000kHz
P05.46	Corresponding setting of lower limit frequency of HDIB	-300.0%~300.0%	0.0%

Function code	Name	Detailed parameter description	Default value
P05.47	Upper limit frequency of HDIB	P05.45 -50.000kHz	50.000kHz
P05.48	Corresponding setting of upper limit frequency of HDIB	-300.0%-300.0%	100.0%
P05.49	HDIB frequency input filter time	0.000s-10.000s	0.030s
P05.50	AI1 input signal type	0-1 0: Voltage type 1: Current type	0

5.5.10 Analog output

The GD350 IP54 series VFD carries one analog output terminal (0-10V/0-20mA) and one high-speed pulse output terminal. Analog output signals can be filtered separately, and the proportional relation can be adjusted by setting the max. value, min. value, and the percentage of their corresponding output. Analog output signal can output motor speed, output frequency, output current, motor torque and motor power at a certain proportion.

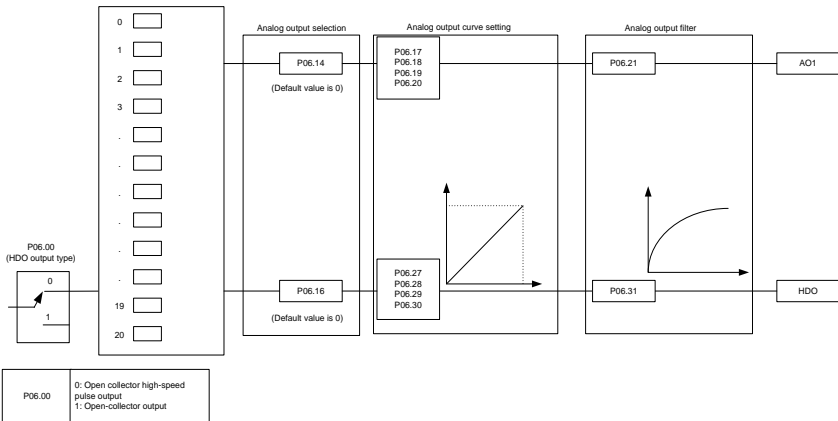

AO output relationship description:

(The min. value and max. value of the output correspond to 0.% and 100.00% of the pulse or analog default output. The actual output voltage or pulse frequency corresponds to the actual percentage, which can be through function codes.)

Set value	Function	Description
0	Running frequency	0-Max. output frequency
1	Set frequency	0-Max. output frequency

Set value	Function	Description
2	Ramps reference frequency	0–Max. output frequency
3	Running speed	0–Synchronous speed corresponding to max. output frequency
4	Output current (relative to VFD)	0–Two times of rated current of VFD
5	Output current (relative to motor)	0–Two times of rated current of motor
6	Output voltage	0–1.5 times of rated voltage of VFD
7	Output power	0–Two times of rated power of motor
8	Set torque value	0–Twice the motor rated current. A negative value corresponds to 0.0% by default.
9	Output torque	0 – +/- (Twice the motor rated torque)
10	AI1 input value	0–10V/0–20mA
11	AI2 input value	0V–10V. A negative value corresponds to 0.0% by default.
12	AI3 input value	0–10V/0–20mA
13	Input value of high-speed pulse HDIA	0.00–50.00kHz
14	Set value 1 of Modbus communication	-1000–1000
15	Set value 2 of Modbus communication	-1000–1000
16	Set value 1 of PROFIBUS/CANopen/DeviceNet communication	-1000–1000
17	Set value 2 of PROFIBUS/CANopen/DeviceNet communication	-1000–1000
18	Set value 1 of Ethernet communication	-1000–1000
19	Set value 2 of Ethernet communication	-1000–1000
20	Input value of high-speed pulse HDIB	0.00–50.00kHz
21	Set value 1 of EtherCAT/PROFINET communication	0–1000. A negative value corresponds to 0.0% by default.
22	Torque current (bipolar)	0–Triple the motor rated current. A negative value corresponds to 0.0% by default.

Set value	Function	Description
23	Exciting current	0–Triple the motor rated current. A negative value corresponds to 0.0% by default.
24	Set frequency (bipolar)	0–Max. output frequency. A negative value corresponds to 0.0% by default.
25	Ramp reference frequency (bipolar)	0–Max. output frequency. A negative value corresponds to 0.0% by default.
26	Running speed (bipolar)	0–Synchronous speed corresponding to max. output frequency. A negative value corresponds to 0.0% by default.
27	Set value 2 of EtherCAT/PROFINET communication	0–1000
28	C_AO1 from PLC	0–1000
29	C_AO2 from PLC	0–1000
30	Running speed	0–Twice the motor rated synchronous speed.
31	Output torque (bipolar)	0–Twice the motor rated torque. A negative value corresponds to 0.0% by default.
32–47	Reserved	

Related parameter list:

Function code	Name	Detailed parameter description	Default value
P06.00	HDO output type	0: Open collector high-speed pulse output 1: Open collector output	0
P06.14	AO1 output selection	0: Running frequency (0–Max. output frequency)	0
P06.15	Reserved	1: Set frequency (0–Max. output frequency)	0
P06.16	HDO high-speed pulse output	2: Ramp reference frequency (0–Max. output frequency) 3: Rotational speed (0–Speed corresponding to max. output frequency) 4: Output current (0–Twice the VFD rated current) 5: Output current (0–Twice the motor rated current)	0

Function code	Name	Detailed parameter description	Default value
		<p>6: Output voltage (0–1.5 times the VFD rated voltage)</p> <p>7: Output power (0–Twice the motor rated power)</p> <p>8: Set torque (0–Twice the motor rated current)</p> <p>9: Output torque (Absolute value, 0–+/- Twice the motor rated torque)</p> <p>10: AI1 input (0–10V/0–20mA)</p> <p>11: AI2 input (0–10V)</p> <p>12: AI3 input (0–10V/0–20mA)</p> <p>13: HDIA input(0.00–50.00kHz)</p> <p>14: Value 1 set through Modbus (0–1000)</p> <p>15: Value 2 set through Modbus (0–1000)</p> <p>16: Value 1 set through PROFIBUS/CANopen/DeviceNet (0–1000)</p> <p>17: Value 2 set through PROFIBUS/CANopen/DeviceNet (0–1000)</p> <p>18: Value 1 set through Ethernet 1 (0–1000)</p> <p>19: Value 2 set through Ethernet 2 (0–1000)</p> <p>20: HDIB input (0.00–50.00kHz)</p> <p>21: Value 1 set through EtherCAT/Profinet/EtherNetIP (0–1000)</p> <p>22: Torque current (bipolar, 0–Triple the motor rated current)</p> <p>23: Exciting current (bipolar, 0–Triple the motor rated current)</p> <p>24: Set frequency (bipolar, 0–Max. output frequency)</p> <p>25: Ramp reference frequency (bipolar, 0–Max. output frequency)</p> <p>26: Rotational speed (bipolar, 0–Speed</p>	

Function code	Name	Detailed parameter description	Default value
		corresponding to max. output frequency) 27: Value 2 set through EtherCAT/Profinet/EtherNetIP (0–1000) 28: C_AO1 (Set P27.00 to 1. 0–1000) 29: C_AO2 (Set P27.00 to 1. 0–1000) 30: Rotational speed (0–Twice the motor rated synchronous speed) 31: Output torque (Actual value, 0–Twice the motor rated torque) 32–47: ReservedEtherCATEtherCAT	
P06.17	Lower limit of AO1 output	-300.0%–P06.19	0.0%
P06.18	Corresponding AO1 output of lower limit	0.00V–10.00V	0.00V
P06.19	Upper limit of AO1 output	P06.17–300.0%	100.0%
P06.20	Corresponding AO1 output of upper limit	0.00V–10.00V	10.00V
P06.21	AO1 output filter time	0.000s–10.000s	0.000s
P06.22–P06.26	Reserved variable	0–65535	0
P06.27	Lower limit of HDO output	-300.0%–P06.29	0.0%
P06.28	Corresponding HDO output of lower limit	0.00–50.00kHz	0.0kHz
P06.29	Upper limit of HDO output	P06.27–300.0%	100.0%
P06.30	Corresponding HDO output of upper limit	0.00–50.00kHz	50.00kHz
P06.31	HDO output filter time	0.000s–10.000s	0.000s

5.5.11 Digital input

The GD350 IP54 series VFD carries four programmable digital input terminals and two HDI input terminals. The function of all the digital input terminals can be programmed by function codes. HDI input terminal can be set to act as high-speed pulse input terminal or common digital input terminal; if it is set to act as high-speed pulse input terminal, users can also set HDIA or HDIB high-speed pulse input to serve as the frequency reference and encoder signal input.

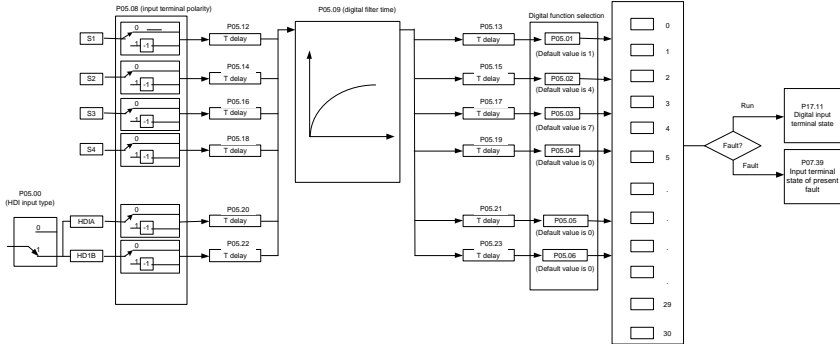

This parameter is used to set the corresponding function of digital multi-function input terminals.

Note: Two different multi-function input terminals cannot be set to the same function.

Set value	Function	Description
0	No function	The VFD does not act even if there is signal input; users can set the unused terminals to "no function" to avoid misacts.
1	Forward running (FWD)	Control the forward/reverse running of the VFD by external terminals.
2	Reverse running (REV)	
3	3-wire control	Set the VFD running mode to the 3-wire control mode by this terminal. See P05.13 for details.
4	Forward jogging	Frequency when jogging, see P08.06, P08.07 and P08.08 for jogging acceleration/deceleration time.
5	Reverse jogging	
6	Coast to stop	The VFD blocks output, and the stop process of motor is uncontrolled by the VFD. This mode is applied in cases of large-inertia load and free stop time; its definition is the same with P01.08, and it is mainly used in remote control.
7	Fault reset	External fault reset function, its function is the same with the STOP/RST key on the keypad. This function can be used in remote fault reset.
8	Running pause	The VFD decelerates to stop, however, all the running parameters are in memory state, eg PLC parameter, wobbling frequency, and PID parameter. After this signal disappears, the VFD will revert to the state before stop.
9	External fault input	When external fault signal is transmitted to the VFD, the VFD releases fault alarm and stops.

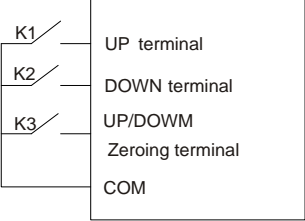
Set value	Function	Description								
10	Frequency increase (UP)	<p>Used to change the frequency-increase/decrease command when the frequency is given by external terminals.</p>  <p>The terminal used to clear frequency-increase/decrease setting can clear the frequency value of auxiliary channel set by UP/DOWN, thus restoring the reference frequency to the frequency given by main reference frequency command channel.</p>								
11	Frequency decrease (DOWN)									
12	Clear frequency increase/decrease setting									
13	Switching between A setting and B setting	<p>This function is used to switch between the frequency setting channels.</p> <p>A frequency reference channel and B frequency reference channel can be switched by no. 13 function; the combination channel set by P00.09 and the A frequency reference channel can be switched by no. 14 function; the combination channel set by P00.09 and the B frequency reference channel can be switched by no. 15 function.</p>								
14	Switching between combination setting and A setting									
15	Switching between combination setting and B setting									
16	Multi-step speed terminal 1	<p>16-step speeds can be set by combining digital states of these four terminals.</p> <p>Note: Multi-step speed 1 is low bit, multi-step speed 4 is high bit.</p> <table border="1" data-bbox="493 1147 975 1254"> <tr> <td>Multi-step speed 4</td> <td>Multi-step speed 3</td> <td>Multi-step speed 2</td> <td>Multi-step speed 1</td> </tr> <tr> <td>BIT3</td> <td>BIT2</td> <td>BIT1</td> <td>BIT0</td> </tr> </table>	Multi-step speed 4	Multi-step speed 3	Multi-step speed 2	Multi-step speed 1	BIT3	BIT2	BIT1	BIT0
Multi-step speed 4	Multi-step speed 3		Multi-step speed 2	Multi-step speed 1						
BIT3	BIT2		BIT1	BIT0						
17	Multi-step speed terminal 2									
18	Multi-step speed terminal 3									
19	Multi-step speed terminal 4									
20	Multi-step speed pause	<p>Pause multi-step speed selection function to keep the set value in present state.</p>								

Set value	Function	Description																				
21	Acceleration/deceleration time selection 1	Use these two terminals to select four groups of acceleration/decoration time.																				
		<table border="1"> <thead> <tr> <th>Terminal 1</th> <th>Terminal 2</th> <th>Acceleration or deceleration time selection</th> <th>Corresponding parameter</th> </tr> </thead> <tbody> <tr> <td>OFF</td> <td>OFF</td> <td>Acceleration/ deceleration time 1</td> <td>P00.11/P00.12</td> </tr> <tr> <td>ON</td> <td>OFF</td> <td>Acceleration/ deceleration time 2</td> <td>P08.00/P08.01</td> </tr> <tr> <td>OFF</td> <td>ON</td> <td>Acceleration/ deceleration time 3</td> <td>P08.02/P08.03</td> </tr> <tr> <td>ON</td> <td>ON</td> <td>Acceleration/ deceleration time 4</td> <td>P08.04/P08.05</td> </tr> </tbody> </table>	Terminal 1	Terminal 2	Acceleration or deceleration time selection	Corresponding parameter	OFF	OFF	Acceleration/ deceleration time 1	P00.11/P00.12	ON	OFF	Acceleration/ deceleration time 2	P08.00/P08.01	OFF	ON	Acceleration/ deceleration time 3	P08.02/P08.03	ON	ON	Acceleration/ deceleration time 4	P08.04/P08.05
		Terminal 1	Terminal 2	Acceleration or deceleration time selection	Corresponding parameter																	
		OFF	OFF	Acceleration/ deceleration time 1	P00.11/P00.12																	
ON	OFF	Acceleration/ deceleration time 2	P08.00/P08.01																			
OFF	ON	Acceleration/ deceleration time 3	P08.02/P08.03																			
ON	ON	Acceleration/ deceleration time 4	P08.04/P08.05																			
22	Acceleration/deceleration time selection 2	OFF ON Acceleration/ deceleration time 3 P08.02/P08.03																				
		ON ON Acceleration/ deceleration time 4 P08.04/P08.05																				
23	Simple PLC stop reset	Restart simple PLC process and clear previous PLC state information.																				
24	Simple PLC pause	The program pauses during PLC execution, and keeps running in current speed step. After this function is cancelled, simple PLC keeps running.																				
25	PID control pause	PID is ineffective temporarily, and the VFD maintains current frequency output.																				
26	Wobbling frequency pause (stop at current frequency)	The VFD pauses at current output. After this function is canceled, it continues wobbling-frequency operation at current frequency.																				
27	Wobbling frequency reset (revert to center frequency)	The set frequency of VFD reverts to center frequency.																				
28	Counter reset	Zero out the counter state.																				
29	Switching between speed control and torque control	The VFD switches from torque control mode to speed control mode, or vice versa.																				
30	Acceleration/deceleration disabled	Ensure the VFD will not be impacted by external signals (except for stop command), and maintains current output frequency.																				
31	Counter trigger	Enable pulse counting of the counter.																				
33	Clear frequency increase/decrease setting temporarily	When the terminal is closed, the frequency value set by UP/DOWN can be cleared to restore the reference frequency to the frequency given by frequency command channel; when terminal is disconnected, it will revert to the frequency value after frequency increase/decrease setting.																				

Set value	Function	Description
34	DC brake	The VFD starts DC brake immediately after the command becomes valid.
35	Switching between motor 1 and motor 2	When this terminal is valid, users can realize switch-over control of two motors.
36	Command switches to keypad	When this terminal is valid, the running command channel will switch to keypad compulsorily. If this function becomes invalid, the running command channel will revert to the original state.
37	Command switches to terminal	When this terminal is valid, the running command channel will switch to terminal compulsorily. If this function becomes invalid, the running command channel will revert to the original state.
38	Command switches to communication	When this terminal is valid, the running command channel will switch to communication compulsorily. If this function becomes invalid, the running command channel will revert to the original state.
39	Pre-exciting command	When this terminal is valid, motor pre-exciting will be started until this terminal becomes invalid.
40	Zero out power consumption quantity	After this command becomes valid, the power consumption quantity of the VFD will be zeroed out.
41	Maintain power consumption quantity	When this command is valid, current operation of the VFD will not impact the power consumption quantity.
42	Source of upper torque limit switches to keypad	When this command is valid, the upper limit of the torque will be set by keypad
56	Emergency stop	When this command is valid, the motor decelerate to emergency stop as per the time set by P01.26.
57	Motor over-temperature fault input	Motor stops at motor over-temperature fault input.
59	FVC switches to V/F control	When this terminal is valid in stop state, switch to SVPWM control.
60	Switch to FVC control	When this terminal is valid in stop state, switch to closed-loop vector control.
61	PID polarity switch-over	Switching the output polarity of PID, this terminal should be used in conjunction with P09.03
66	Zero out the counter	Zero out the position counting value
67	Pulse increase	When the terminal function is valid, the pulse input is increased according to the P21.27 pulse speed.

Set value	Function	Description
68	Enable pulse superimposition	When the pulse superimposition is enabled, pulse increase and pulse decrease are effective.
69	Pulse decrease	When the terminal function is valid, the pulse input is decreased according to the P21.27 pulse speed.
70	Electronic gear selection	When the terminal is valid, the proportional numerator is switched to the P21.30 numerator of the 2 nd command ratio.
71	Switch to mater	In stopped state, if the function is valid, the master is used.
72	Switch to slave	In stopped state, if the function is valid, the slave is used.
73–79	Reserved	/

Related parameter list:

Function code	Name	Detailed parameter description	Default value
P05.00	HDI input type	0x00–0x11 Ones: HDIA input type 0: HDIA is high-speed pulse input 1: HDIA is digital input Tens: HDIB input type 0: HDIB is high-speed pulse input 1: HDIB is digital input	0x00
P05.01	Function of S1 terminal	0: No function	1
P05.02	Function of S2 terminal	1: Forward running	4
P05.03	Function of S3 terminal	2: Reverse running	7
P05.04	Function of S4 terminal	3: 3-wire control	0
P05.05	Function of HDIA terminal	4: Forward jogging	0
P05.06	Function of HDIB terminal	5: Reverse jogging	0
P05.07	Reserved variables	6: Coast to stop 7: Fault reset 8: Running pause 9: External fault input 10: Frequency increase (UP) 11: Frequency decrease (DOWN) 12: Clear frequency increase/decrease setting 13: Switch-over between setup A and setup B	0

Function code	Name	Detailed parameter description	Default value
		14: Switch-over between combination setting and A setting 15: Switch-over between combination setting and setup B 16: Multi-step speed terminal 1 17: Multi-step speed terminal 2 18: Multi-step speed terminal 3 19: Multi-step speed terminal 4 20: Multi-step speed pause 21: Acceleration/deceleration time selection 1 22: Acceleration/deceleration time selection 2 23: Simple PLC stop reset 24: Simple PLC pause 25: PID control pause 26: Wobbling frequency pause 27: Wobbling frequency reset 28: Counter reset 29: Switching between speed control and torque control 30: Acceleration/deceleration disabled 31: Counter trigger 32: Reserved 33: Clear frequency increase/decrease setting temporarily 34: DC brake 35: Switching between motor 1 and motor 2 36: Command switches to keypad 37: Command switches to terminal 38: Command switches to communication 39: Pre-exciting command 40: Zero out power consumption quantity	

Function code	Name	Detailed parameter description	Default value
		41: Maintain power consumption quantity 42: Source of upper torque limit switches to keypad 56: Emergency stop 57: Motor over-temperature fault input 59: Switch to V/F control 60: Switch to FVC control 61: PID polarity switch-over 66: Zero out encoder counting 67: Pulse increase 68: Enable pulse superimposition 69: Pulse decrease 70: Electronic gear selection 71: Switch to master 72: Switch to slave 73–79: Reserved	
P05.08	Polarity of input terminal	0x00–0x3F	0x00
P05.09	Digital filter time	0.000–1.000s	0.010s
P05.10	Virtual terminal setting	0x00–0x3F (0: disable, 1: enable) BIT0: S1 virtual terminal BIT1: S2 virtual terminal BIT2: S3 virtual terminal BIT3: S4 virtual terminal BIT4: HDIA virtual terminal BIT8: HDIB virtual terminal	0x00
P05.11	2/3 wire control mode	0: 2-wire control 1 1: 2-wire control 2 2: 3-wire control 1 3: 3-wire control 2	0
P05.12	S1 terminal switch-on delay	0.000–50.000s	0.000s
P05.13	S1 terminal switch-off delay	0.000–50.000s	0.000s
P05.14	S2 terminal switch-on delay	0.000–50.000s	0.000s
P05.15	S2 terminal switch-off delay	0.000–50.000s	0.000s
P05.16	S3 terminal switch-on delay	0.000–50.000s	0.000s

Function code	Name	Detailed parameter description	Default value
P05.17	S3 terminal switch-off delay	0.000–50.000s	0.000s
P05.18	S4 terminal switch-on delay	0.000–50.000s	0.000s
P05.19	S4 terminal switch-off delay	0.000–50.000s	0.000s
P05.20	HDIA terminal switch-on delay	0.000–50.000s	0.000s
P05.21	HDIA terminal switch-off delay	0.000–50.000s	0.000s
P05.22	HDIB terminal switch-on delay	0.000–50.000s	0.000s
P05.23	HDIB terminal switch-off delay	0.000–50.000s	0.000s
P07.39	Input terminal state of present fault	/	0
P17.12	Digital input terminal state	/	0

5.5.12 Digital output

The GD350 IP54 series VFD carries two groups of relay output terminals, one open collector Y output terminal and one high-speed pulse output (HDO) terminal. The function of all the digital output terminals can be programmed by function codes, of which the high-speed pulse output terminal HDO can also be set to high-speed pulse output or digital output by function code.

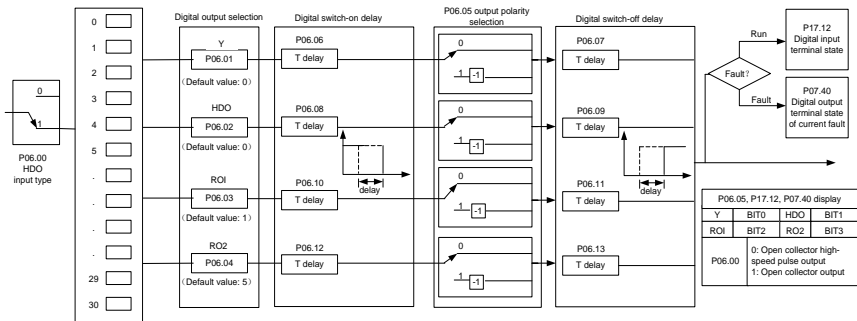

The table below lists the options for the above four function parameters, and users are allowed to select the same output terminal functions repetitively.

Set value	Function	Description
0	Invalid	Output terminal has no function
1	In running	Output ON signal when there is frequency output during running
2	In forward running	Output ON signal when there is frequency output during forward running

Set value	Function	Description
3	In reverse running	Output ON signal when there is frequency output during reverse running
4	In jogging	Output ON signal when there is frequency output during jogging
5	VFD fault	Output ON signal when VFD fault occurred
6	Frequency level detection FDT1	Refer to P08.32 and P08.33
7	Frequency level detection FDT2	Refer to P08.34 and P08.35
8	Frequency reached	Refer to P08.36
9	Running in zero speed	Output ON signal when the VFD output frequency and reference frequency are both zero.
10	Reach upper limit frequency	Output ON signal when the running frequency reaches upper limit frequency
11	Reach lower limit frequency	Output ON signal when the running frequency reached lower limit frequency
12	Ready to run	Main circuit and control circuit powers are established, the protection functions do not act; when the VFD is ready to run, output ON signal.
13	In pre-exciting	Output ON signal during pre-exciting of the VFD
14	Overload pre-alarm	Output ON signal after the pre-alarm time elapsed based on the pre-alarm threshold; see P11.08–P11.10 for details.
15	Underload pre-alarm	Output ON signal after the pre-alarm time elapsed based on the pre-alarm threshold; see P11.11–P11.12 for details.
16	Simple PLC state completed	Output signal when current stage of simple PLC is completed
17	Simple PLC cycle completed	Output signal when a single cycle of simple PLC operation is completed
23	Virtual terminal output of Modbus communication	Output corresponding signal based on the set value of Modbus; output ON signal when it is set to 1, output OFF signal when it is set to 0
24	Virtual terminal output of PROFIBUS/CANopen communication	Output corresponding signal based on the set value of PROFIBUS/CANopen; output ON signal when it is set to 1, output OFF signal when it is set to 0

Set value	Function	Description
25	Virtual terminal output of Ethernet communication	Output corresponding signal based on the set value of Ethernet; output ON signal when it is set to 1, output OFF signal when it is set to 0.
26	DC bus voltage established	Output is valid when the bus voltage is above the undervoltage threshold of the inverter.
27	Z pulse output	Output is valid when the encoder Z pulse is arrived, and is invalid after 10 ms.
28	During pulse superposition	Output is valid when the pulse superposition terminal input function is valid
29	STO action	Output when STO fault occurred
30	Positioning completed	Output is valid when position control positioning is completed
31	Spindle zeroing completed	Output is valid when spindle zeroing is completed
32	Spindle scale-division completed	Output is valid when spindle scale-division is completed
33	In speed limit	Output is valid when the frequency is limited
34	Virtual terminal output of EtherCAT/PROFINET communication	The corresponding signal is output according to the set value of PROFINET communication. When it is set to 1, the ON signal is output, and when it is set to 0, the OFF signal is output.
35	Reserved	
36	Speed/position control switch-over completed	Output is valid when the mode switch-over is completed
37–40	Reserved	
41	C_Y1	C_Y1 from PLC (set P27.00 to 1)
42	C_Y2	C_Y2 from PLC (set P27.00 to 1)
43	C_HDO	C_HDO from PLC (set P27.00 to 1)
44	C_RO1	C_RO1 from PLC (set P27.00 to 1)
45	C_RO2	C_RO2 from PLC (set P27.00 to 1)
46	C_RO3	C_RO3 from PLC (set P27.00 to 1)
47	C_RO4	C_RO4 from PLC (set P27.00 to 1)
48–63	Reserved variables	/

Related parameter list:

Function code	Name	Detailed parameter description	Default value
P06.00	HDO output type	0: Open collector high-speed pulse output 1: Open collector output	0

Function code	Name	Detailed parameter description	Default value
P06.01	Y1 output selection	0: Invalid	0
P06.02	HDO output selection	1: In running	0
P06.03	Relay RO1 output selection	2: In forward running 3: In reverse running	1
P06.04	Relay RO2 output selection	4: In jogging 5: VFD fault 6: Frequency level detection FDT1 7: Frequency level detection FDT2 8: Frequency reached 9: Running in zero speed 10: Reach upper limit frequency 11: Reach lower limit frequency 12: Ready to run 13: In pre-exciting 14: Overload pre-alarm 15: Underload pre-alarm 16: Simple PLC stage completed 17: Simple PLC cycle completed 18: Reach set counting value 19: Reach designated counting value 20: External fault is valid 21: Reserved 22: Reach running time 23: Virtual terminal output of Modbus communication 24: Virtual terminal output of POROFIBUS/CANopen communication 25: Virtual terminal output of Ethernet communication 26: DC bus voltage established 27: Z pulse output 28: During pulse superposition 29: STO action 30: Positioning completed 31: Spindle zeroing completed 32: Spindle scale-division completed 33: In speed limit 34: Virtual terminal output of	5

Function code	Name	Detailed parameter description	Default value
		EtherCAT/PROFINET communication 35: Reserved 36: Speed/position control switch-over completed 37: Any frequency reached 38–40: Reserved 41: C_Y1 from PLC (set P27.00 to 1) 42: C_Y2 from PLC (set P27.00 to 1) 43: C_HDO from PLC (set P27.00 to 1) 44: C_RO1 from PLC (set P27.00 to 1) 45: C_RO2 from PLC (set P27.00 to 1) 46: C_RO3 from PLC 3 (set P27.00 to 1) 47: C_RO4 from PLC (set P27.00 to 1) 48–63: Reserved	
P06.05	Output terminal polarity selection	0x00–0x0F	0x00
P06.06	Y switch-on delay	0.000–50.000s	0.000s
P06.07	Y switch-off delay	0.000–50.000s	0.000s
P06.08	HDO switch-on delay	0.000–50.000s (valid only when P06.00=1)	0.000s
P06.09	HDO switch-off delay	0.000–50.000s (valid only when P06.00=1)	0.000s
P06.10	Relay RO1 switch-on delay	0.000–50.000s	0.000s
P06.11	Relay RO1 switch-off delay	0.000–50.000s	0.000s
P06.12	Relay RO2 switch-on delay	0.000–50.000s	0.000s
P06.13	Relay RO2 switch-off delay	0.000–50.000s	0.000s
P07.40	Output terminal state of present fault	/	0
P17.13	Digital output terminal state	/	0

5.5.13 Simple PLC

Simple PLC is a multi-step speed generator, and the VFD can change the running frequency and direction automatically based on the running time to fulfill process requirements. Previously, such function was realized with external PLC, while now, the VFD itself can achieve this function.

The GD350 IP54 series VFD can realize 16-step speeds control, and provide four groups of acceleration/deceleration time for users to choose from.

After the configured PLC completes a cycle (or stage), an ON signal can be output by the multi-function relay.

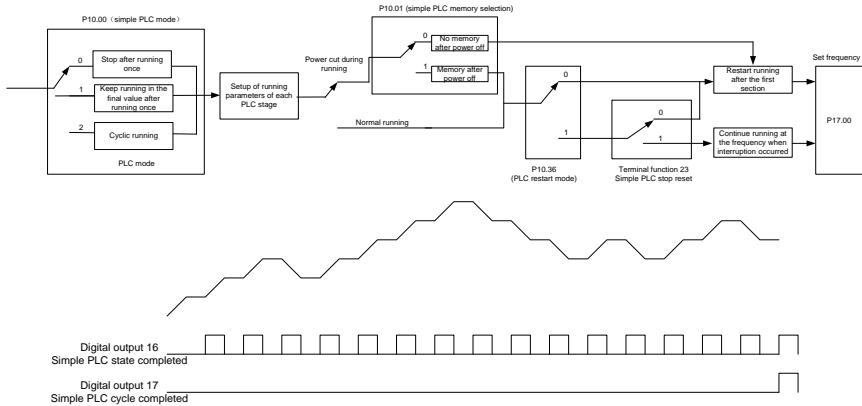

Related parameter list:

Function code	Name	Detailed parameter description	Default value
P05.01–P05.06	Digital input function	23: Simple PLC stop reset 24: Simple PLC pause 25: PID control pause	
P06.01–P06.04	Digital output function	16: Simple PLC stage reached 17: Simple PLC cycle reached	
P10.00	Simple PLC mode	0: Stop after running once 1: Keep running in the final value after running once 2: Cyclic running	0
P10.01	Simple PLC memory selection	0: No memory after power down 1: Memory after power down	0
P10.02	Multi-step speed 0	-100.0–100.0%	0.0%
P10.03	Running time of 0 th step	0.0–6553.5s (min)	0.0s
P10.04	Multi-step speed 1	-100.0–100.0%	0.0%
P10.05	Running time of 1 st step	0.0–6553.5s (min)	0.0s
P10.06	Multi-step speed 2	-100.0–100.0%	0.0%
P10.07	Running time of 2 nd step	0.0–6553.5s (min)	0.0s

Function code	Name	Detailed parameter description	Default value
P10.08	Multi-step speed 3	-100.0–100.0%	0.0%
P10.09	Running time of 3 rd step	0.0–6553.5s (min)	0.0s
P10.10	Multi-step speed 4	-100.0–100.0%	0.0%
P10.11	Running time of 4 th step	0.0–6553.5s (min)	0.0s
P10.12	Multi-step speed 5	-100.0–100.0%	0.0%
P10.13	Running time of 5 th step	0.0–6553.5s (min)	0.0s
P10.14	Multi-step speed 6	-100.0–100.0%	0.0%
P10.15	Running time of 6 th step	0.0–6553.5s (min)	0.0s
P10.16	Multi-step speed 7	-100.0–100.0%	0.0%
P10.17	Running time of 7 th step	0.0–6553.5s (min)	0.0s
P10.18	Multi-step speed 8	-100.0–100.0%	0.0%
P10.19	Running time of 8 th step	0.0–6553.5s (min)	0.0s
P10.20	Multi-step speed 9	-100.0–100.0%	0.0%
P10.21	Running time of 9 th step	0.0–6553.5s (min)	0.0s
P10.22	Multi-step speed 10	-100.0–100.0%	0.0%
P10.23	Running time of 10 th step	0.0–6553.5s (min)	0.0s
P10.24	Multi-step speed 11	-100.0–100.0%	0.0%
P10.25	Running time of 11 th step	0.0–6553.5s (min)	0.0s
P10.26	Multi-step speed 12	-100.0–100.0%	0.0%
P10.27	Running time of 12 th step	0.0–6553.5s (min)	0.0s
P10.28	Multi-step speed 13	-100.0–100.0%	0.0%
P10.29	Running time of 13 th step	0.0–6553.5s (min)	0.0s
P10.30	Multi-step speed 14	-100.0–100.0%	0.0%
P10.31	Running time of 14 th step	0.0–6553.5s (min)	0.0s
P10.32	Multi-step speed 15	-100.0–100.0%	0.0%
P10.33	Running time of 15 th step	0.0–6553.5s (min)	0.0s
P10.36	PLC restart mode	0: Restart from the first section 1: Continue running at the frequency when interruption occurred	0
P10.34	Acceleration/deceleration time of 0–7 stage of simple PLC	0x0000–0XFFFF	0000

Function code	Name	Detailed parameter description	Default value
P10.35	Acceleration/deceleration time of 8–15 stage of simple PLC	0x0000–0XFFFF	0000
P17.00	Set frequency	0.00Hz–P00.03 (max. output frequency)	0.00Hz
P17.27	Actual stage of simple PLC	Displays the present stage of the simple PLC function.	0

5.5.14 Multi-step speed running

Set the parameters used in multi-step speed running. the GD350 IP54 series VFD can set 16-step speeds, which are selectable by multi-step speed terminals 1–4, corresponding to multi-step speed 0 to multi-step speed 15.

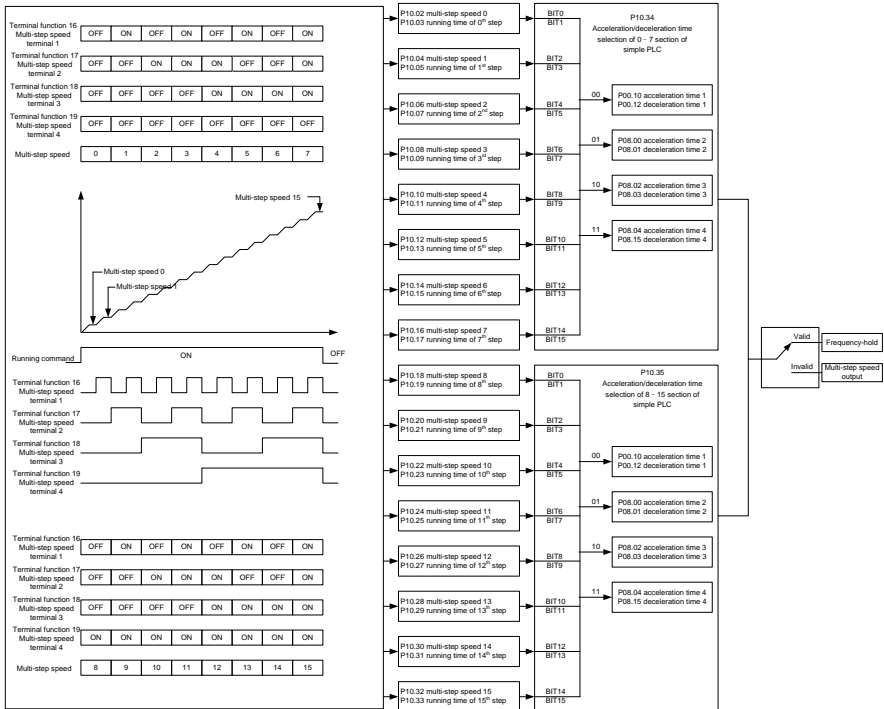

Related parameter list:

Function code	Name	Detailed parameter description	Default value
P05.01– P05.06	Digital input function selection	16: Multi-step speed terminal 1 17: Multi-step speed terminal 2 18: Multi-step speed terminal 3 19: Multi-step speed terminal 4 20: Multi-step speed pause	
P10.02	Multi-step speed 0	-100.0–100.0%	0.0%
P10.03	Running time of 0 th step	0.0–6553.5s (min)	0.0s
P10.04	Multi-step speed 1	-100.0–100.0%	0.0%
P10.05	Running time of 1 st step	0.0–6553.5s (min)	0.0s
P10.06	Multi-step speed 2	-100.0–100.0%	0.0%
P10.07	Running time of 2 nd step	0.0–6553.5s (min)	0.0s
P10.08	Multi-step speed 3	-100.0–100.0%	0.0%
P10.09	Running time of 3 rd step	0.0–6553.5s (min)	0.0s
P10.10	Multi-step speed 4	-100.0–100.0%	0.0%
P10.11	Running time of 4 th step	0.0–6553.5s (min)	0.0s
P10.12	Multi-step speed 5	-100.0–100.0%	0.0%
P10.13	Running time of 5 th step	0.0–6553.5s (min)	0.0s
P10.14	Multi-step speed 6	-100.0–100.0%	0.0%
P10.15	Running time of 6 th step	0.0–6553.5s (min)	0.0s
P10.16	Multi-step speed 7	-100.0–100.0%	0.0%
P10.17	Running time of 7 th step	0.0–6553.5s (min)	0.0s
P10.18	Multi-step speed 8	-100.0–100.0%	0.0%
P10.19	Running time of 8 th step	0.0–6553.5s (min)	0.0s
P10.20	Multi-step speed 9	-100.0–100.0%	0.0%
P10.21	Running time of 9 th step	0.0–6553.5s (min)	0.0s
P10.22	Multi-step speed 10	-100.0–100.0%	0.0%
P10.23	Running time of 10 th step	0.0–6553.5s (min)	0.0s
P10.24	Multi-step speed 11	-100.0–100.0%	0.0%
P10.25	Running time of 11 th step	0.0–6553.5s (min)	0.0s
P10.26	Multi-step speed 12	-100.0–100.0%	0.0%
P10.27	Running time of 12 th step	0.0–6553.5s (min)	0.0s
P10.28	Multi-step speed 13	-100.0–100.0%	0.0%
P10.29	Running time of 13 th step	0.0–6553.5s (min)	0.0s
P10.30	Multi-step speed 14	-100.0–100.0%	0.0%
P10.31	Running time of 14 th step	0.0–6553.5s (min)	0.0s

Function code	Name	Detailed parameter description	Default value
P10.32	Multi-step speed 15	-100.0–100.0%	0.0%
P10.33	Running time of 15 th step	0.0–6553.5s (min)	0.0s
P10.34	Acceleration/decoration time selection of 0–7 section of simple PLC	0x0000–0xFFFF	0000
P10.35	Acceleration/decoration time selection of 8–15 section of simple PLC	0x0000–0xFFFF	0000
P17.27	Actual stage of simple PLC	Displays the present stage of the simple PLC function.	0

5.5.15 PID control

PID control, a common mode for process control, is mainly used to adjust the VFD output frequency or output voltage through performing scale-division, integral and differential operations on the difference between feedback signal of controlled variables and signal of the target, thus forming a negative feedback system to keep the controlled variables above the target. It is suitable for flow control, pressure control, temperature control, etc. Diagram of basic principles for output frequency regulation is shown in the figure below.

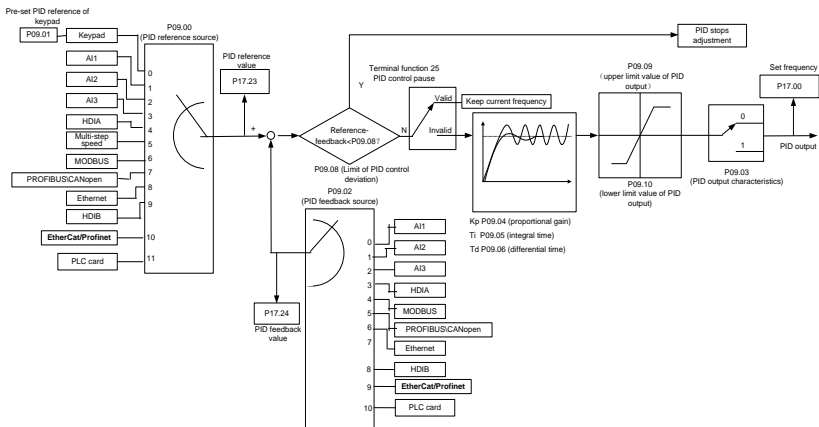

Introduction to the working principles and control methods for PID control

Proportional control (Kp):

When the feedback deviates from the reference, the output will be proportional to the deviation, if such deviation is constant, the regulating variable will also be constant. Proportional control can respond to feedback changes rapidly, however, it cannot eliminate the error by itself. The larger the

proportional gain, the faster the regulating speed, but too large gain will result in oscillation. To solve this problem, first, set the integral time to a large value and the derivative time to 0, and run the system by proportional control, and then change the reference to observe the deviation between feedback signal and the reference (static difference), if the static difference is (eg, increase the reference, and the feedback variable is always less than the reference after system stabilizes), continue increasing the proportional gain, otherwise, decrease the proportional gain; repeat such process until the static error becomes small.

Integral time (Ti):

When feedback deviates from reference, the output regulating variable accumulates continuously, if the deviation persists, the regulating variable will increase continuously until deviation disappears. Integral regulator can be used to eliminate static difference; however, too large regulation may lead to repetitive overshoot, which will cause system instability and oscillation. The feature of oscillation caused by strong integral effect is that the feedback signal fluctuates up and down based on the reference variable, and fluctuation range increases gradually until oscillation occurred. Integral time parameter is generally regulated gradually from large to small until the stabilized system speed fulfills the requirement.

Derivative time (Td):

When the deviation between feedback and reference changes, output the regulating variable which is proportional to the deviation variation rate, and this regulating variable is only related to the direction and magnitude of the deviation variation rather than the direction and magnitude of the deviation itself. Differential control is used to control the feedback signal variation based on the variation trend. Differential regulator should be used with caution as it may easily enlarge the system interferences, especially those with high variation frequency.

When frequency command selection (P00.06, P00.07) is 7, or channel of voltage setup (P04.27) is 6, the running mode of VFD is process PID control.

5.5.15.1 General procedures for PID parameter setup**a. Determining proportional gain P**

When determining proportional gain P, first, remove the integral term and derivative term of PID by making $T_i=0$ and $T_d=0$ (see PID parameter setup for details), thus turning PID into pure proportional control. Set the input to 60%–70% of the max. allowable value, and increase proportional gain P gradually from 0 until system oscillation occurred, and then in turn, decrease proportional gain P gradually from current value until system oscillation disappears, record the proportional gain P at this point and set the proportional gain P of PID to 60%–70% of current value. This is whole commissioning process of proportional gain P.

b. Determine integral time Ti

After proportional gain P is determined, set the initial value of a larger integral time T_i , and decrease T_i gradually until system oscillation occurred, and then in turn, increase T_i until system oscillation

disappears, record the T_i at this point, and set the integral time constant T_i of PID to 150%–180% of current value. This is the commissioning process of integral time constant T_i .

c. Determining derivative time T_d

The derivative time T_d is generally set to 0.

If users need to set T_d to another value, set in the same way with P and T_i , namely set T_d to 30% of the value when there is no oscillation.

d. Empty system load, perform load-carrying joint debugging, and then fine-tune PID parameter until fulfilling the requirement.

5.5.15.2 How to fine-tune PID

After setting the parameters controlled by PID, users can fine-tune these parameters by the following means.

Control overmodulation: When overmodulation occurred, shorten the derivative time (T_d) and prolong integral time (T_i).

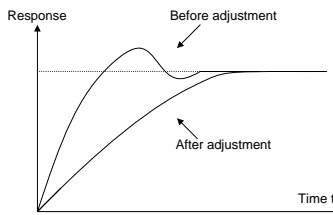

Stabilize the feedback value as fast as possible: when overmodulation occurred, shorten integral time (T_i) and prolong derivative time (T_d) to stabilize control as fast as possible.

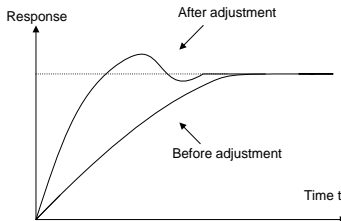

Control long-term vibration: If the cycle of periodic vibration is longer than the set value of integral time (T_i), it indicates the integral action is too strong, prolong the integral time (T_i) to control vibration.

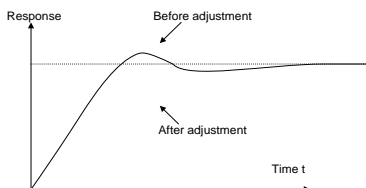

Control short-term vibration: If the vibration cycle is short is almost the same with the set value of derivative time (Td), it indicates derivative action is too strong, shorten the derivative time (Td) to control vibration. When derivative time (Td) is set to 0.00 (namely no derivative control), and there is no way to control vibration, decrease the proportional gain.

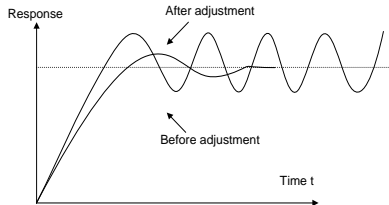

Related parameter list:

Function code	Name	Detailed parameter description	Default value
P09.00	PID reference source	0: Keypad (P09.01) 1: AI1 2: AI2 3: AI3 4: High-speed pulse HDIA 5: Multi-step 6: Modbus communication 7: PROFIBUS/CANopen/DeviceNet communication 8: Ethernet communication 9: High-speed pulse HDIB 10: EtherCAT/PROFINET communication 11: Programmable extension card 12: Reserved	0
P09.01	Pre-set PID reference of keypad	-100.0%–100.0%	0.0%
P09.02	PID feedback source	0: AI1 1: AI2 2: AI3 3: High-speed pulse HDIA 4: Modbus communication 5: PROFIBUS/CANopen/DeviceNet communication 6: Ethernet communication	0

Function code	Name	Detailed parameter description	Default value
		7: High-speed pulse HDIB 8: EtherCAT/PROFINET communication 9: Programmable extension card 10: Reserved	
P09.03	PID output characteristics	0: PID output is positive characteristic 1: PID output is negative characteristic	0
P09.04	Proportional gain (Kp)	0.00–100.00	1.80
P09.05	Integral time (Ti)	0.01–10.00s	0.90s
P09.06	Differential time (Td)	0.00–10.00s	0.00s
P09.07	Sampling cycle (T)	0.000–10.000s	0.100s
P09.08	Limit of PID control deviation	0.0–100.0%	0.0%
P09.09	Upper limit value of PID output	P09.10–100.0% (max. frequency or voltage)	100.0%
P09.10	Lower limit value of PID output	-100.0%–P09.09 (max. frequency or voltage)	0.0%
P09.11	Feedback offline detection value	0.0–100.0%	0.0%
P09.12	Feedback offline detection time	0.0–3600.0s	1.0s
P09.13	PID control selection	0x0000–0x1111 Ones: 0: Continue integral control after the frequency reaches upper/lower limit 1: Stop integral control after the frequency reaches upper/lower limit Tens: 0: The same with the main reference direction 1: Contrary to the main reference direction Hundreds: 0: Limit as per the max. frequency 1: Limit as per A frequency Thousands: 0: A+B frequency, acceleration /deceleration of main reference A	0x0001

Function code	Name	Detailed parameter description	Default value
		frequency source buffering is invalid 1: A+B frequency, acceleration/ deceleration of main reference A frequency source buffering is valid, acceleration/deceleration is determined by P08.04 (acceleration time 4).	
P09.14	Low frequency proportional gain (Kp)	0.00–100.00	1.00
P09.15	ACC/DEC time of PID command	0.0–1000.0s	0.0s
P09.16	PID output filter time	0.000–10.000s	0.000s
P09.17	Reserved	-100.0–100.0%	0.0%
P09.18	Low frequency integral time (Ti)	0.00–10.00s	0.90s
P09.19	Low frequency differential time (Td)	0.00–10.00s	0.00s
P09.20	Low frequency point for PID parameter switching	0.00–P09.21	5.00Hz
P09.21	High frequency point for PID parameter switching	P09.20–P00.04	10.00Hz
P17.00	Set frequency	0.00Hz–P00.03 (max. output frequency)	0.00Hz
P17.23	PID reference value	-100.0–100.0%	0.0%
P17.24	PID feedback value	-100.0–100.0%	0.0%

5.5.16 Run at wobbling frequency

Wobbling frequency is mainly applied in cases where transverse movement and winding functions are needed like textile and chemical fiber industries. The typical working process is shown as below.

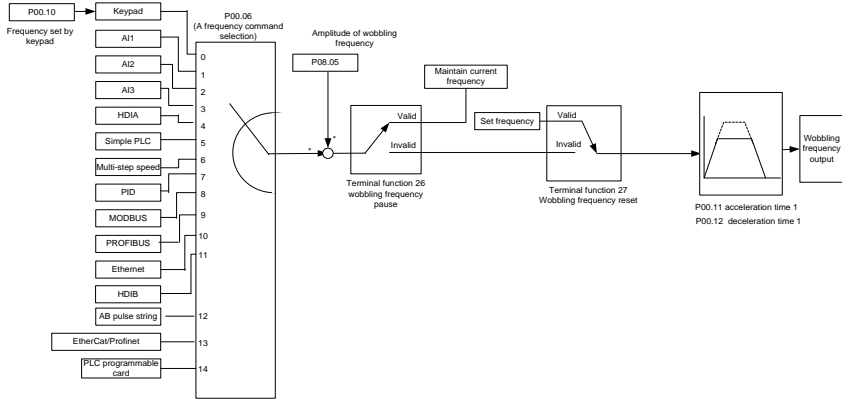

Function code	Name	Detailed parameter description	Default value
P00.03	Max. output frequency	P00.03–400.00Hz	50.00Hz
P00.06	A frequency command selection	0: Set via keypad 1: Set via AI1 2: Set via AI2 3: Set via AI3 4: Set via high speed pulse HDIA 5: Set via simple PLC program 6: Set via multi-step speed running 7: Set via PID control 8: Set via Modbus communication 9: Set via PROFIBUS/CANopen/DeviceNet communication 10: Set via Ethernet communication 11: Set via high speed pulse HDIB 12: Set via pulse string AB 13: Set via EtherCAT/PROFINET communication 14: Set via PLC card	0
P00.11	Acceleration time 1	0.0–3600.0s	Depends on model
P00.12	Deceleration time 1	0.0–3600.0s	Depends on model
P05.01–P05.06	Digital input function selection	26: Wobbling frequency pause (stop at current frequency)	/

Function code	Name	Detailed parameter description	Default value
		27: Wobbling frequency reset (revert to center frequency)	
P08.15	Amplitude of wobbling frequency	0.0–100.0% (relative to set frequency)	0.0%
P08.16	Amplitude of jump frequency	0.0–50.0% (relative to amplitude of wobbling frequency)	0.0%
P08.17	Wobbling frequency rise time	0.1–3600.0s	5.0s
P08.18	Wobbling frequency fall time	0.1–3600.0s	5.0s

5.5.17 Local encoder input

The GD350 IP54 series VFD supports pulse count function by inputting the count pulse from HDI high-speed pulse port. When the actual count value is no less than the set value, digital output terminal will output count-value-reached pulse signal, and the corresponding count value will be zeroed out.

Function code	Name	Detailed parameter description	Default value
P05.00	HDI input type	0x00–0x11 Ones: HDIA input type 0: HDIA is high-speed pulse input 1: HDIA is digital input Tens: HDIB input type 0: HDIB is high-speed pulse input 1: HDIB is digital input	0x00
P05.38	HDIA high-speed pulse input function	0: Set input via frequency 1: Reserved 2: Input via encoder, used in combination with HDIB	0
P05.44	HDIB high-speed pulse input function selection	0: Set input via frequency 1: Reserved 2: Input via encoder, used in combination with HDIA	0
P20.15	Speed measurement mode	0: PG card 1: local; realized by HDIA and HDIB; supports incremental 24V encoder only	0
P18.00	Actual frequency of encoder	-999.9–3276.7Hz	0.0Hz

5.5.18 Commissioning procedures for closed-loop control, position control and spindle positioning

1. Commissioning procedures for closed-loop vector control of asynchronous motor

Step 1: Restore to default value via keypad

Step 2: Set P00.03, P00.04 and P02 group motor nameplate parameters

Step 3: Motor parameter autotuning

Carry out rotary parameter autotuning or static parameter autotuning via keypad, if the motor can be disconnected from load, then it is users can carry out rotary parameter autotuning; otherwise, carry out static parameter autotuning, the parameter obtained from autotuning will be saved in P02 motor parameter group automatically.

Step 4: Verify whether the encoder is installed and set properly

- a) Confirm the encoder direction and parameter setup

Set P20.01 (encoder pulse-per-revolution), set P00.00=2 and P00.10=20Hz, and run the VFD, at this point, the motor rotates at 20Hz, observe whether the speed measurement value of P18.00 is correct, if the value is negative, it indicates the encoder direction is reversed, under such situation, set P20.02 to 1; if the speed measurement value deviates greatly, it indicates P20.01 is set improperly. Observe whether P18.02 (encoder Z pulse count value) fluctuates, if yes, it indicates the encoder suffers interference or P20.01 is set improperly, requiring users to check the wiring and the shielding layer.

- b) Determine Z pulse direction

Set P00.10=20Hz, and set P00.13 (running direction) to forward and reverse direction respectively to observe whether the difference value of P18.02 is less than 5, if the difference value remains to be larger than 5 after setting Z pulse reversal function of P20.02, power off and exchange phase A and phase B of the encoder, and then observe the difference between the value of P18.02 during forward and reverse rotation. Z pulse direction only affects the forward/reverse positioning precision of the spindle positioning carried out with Z pulse.

Step 5: Closed-loop vector pilot-run

Set P00.00=3, and carry out closed-loop vector control, adjust P00.10 and speed loop and current loop PI parameter in P03 group to make it run stably in the whole range.

Step 6: Flux-weakening control

Set flux-weakening regulator gain P03.26=0–8000, and observe the flux-weakening control effect. P03.22–P03.24 can be adjusted as needed.

2. Commissioning procedures for closed-loop vector control of synchronous motor

Step 1: Set P00.18=1, restore to default value

Step 2: Set P00.00=3 (VC) , set P00.03, P00.04, and motor nameplate parameters in P02 group.

Step 3: Set P20.01 encoder parameters

When the encoder is resolver-type encoder, set the encoder pulse count value to (resolver pole pair number \times 1024), eg, if pole pair number is 4, set P20.01 to 4096.

Step 4: Ensure the encoder is installed and set correctly

When motor stops, observe whether P18.21 (resolver angle) fluctuates, if it fluctuates sharply, check the wiring and grounding. Rotates the motor slowly, observe whether P18.21 changes accordingly, if yes, it indicates motor is connected correctly; if the value of P18.02 keeps constant at a non-zero value after rotating for multiple circles, it indicates encoder Z signal is correct.

Step 5: Autotuning of initial position of magnetic pole

Set P20.11=2 or 3 (3: rotary autotuning; 2: static autotuning), press RUN key to run the VFD.

a) Rotary autotuning (P20.11 = 3)

Detect the position of current magnetic pole when autotuning starts, and then accelerates to 10Hz, autotuning corresponding magnetic pole position of encoder Z pulse, and decelerate to stop.

During running, if ENC1O or ENC1D fault occurred, set P20.02=1 and carry out autotuning again.

After autotuning is done, the angle obtained from autotuning will be saved in P20.09 and P20.10 automatically.

b) Static autotuning

In cases where the load can be disconnected, it is recommended to adopt rotary autotuning (P20.11=3) as it has high angle precision. If the load cannot be disconnected, users can adopt static autotuning (P20.11=2). The magnetic pole position obtained from autotuning will be saved in P20.09 and P20.10.

Step 6: Closed-loop vector pilot-run

Adjust P00.10 and speed loop and current loop PI parameter in P03 group to make it run stably in the whole range. If oscillation occurred, reduce the value of P03.00, P03.03, P03.09 and P03.10. If current oscillation noise occurred during low speed, adjust P20.05.

Note: It is necessary to re-determine P20.02 (encoder direction) and carry out magnetic pole position autotuning again if the wiring of motor or encoder is changed.

3. Commissioning procedures for pulse string control

Pulse input is operated based on closed-loop vector control; speed detection is needed in the subsequent spindle positioning, zeroing operation and division operation.

Step 1: Restore to default value by keypad

Step 2: Set P00.03, P00.04 and motor nameplate parameters in P02 group

Step 3: Motor parameter autotuning: rotary parameter autotuning or static parameter autotuning

Step 4: Verify the installation and settings of encoder. Set P00.00=3 and P00.10=20Hz to run the system, and check the control effect and performance of the system.

Step 5: Set P21.00=0001 to set positioning mode to position control, namely pulse-string control. There are four kinds of pulse command modes, which can be set by P21.01 (pulse command mode).

Under position control mode, users can check high bit and low bit of position reference and feedback, P18.02 (count value of Z pulse), P18.00 (actual frequency of encoder), P18.17 (pulse command frequency) and P18.19 (position regulator output) via P18, through which users can figure out the relation between P18.8 (position of position reference point) and P18.02, pulse command frequency P18.17, pulse command feedforward P18.18 and position regulator output P18.19.

Step 6: The position regulator has two gains, namely P21.02 and P21.03, and they can be switched by speed command, torque command and terminals.

Step 7: When P21.08 (output limit of position controller) is set to 0, the position control will be invalid, and at this point, the pulse string acts as frequency source, P21.13 (position feedforward gain) should be set to 100%, and the speed acceleration/deceleration time is determined by the acceleration /deceleration time of pulse string, the pulse string acceleration/deceleration time of the system can be adjusted. If the pulse string acts as the frequency source in speed control, users can also set P21.00 to 0000, and set the frequency source reference P00.06 or P00.07 to 12 (set by pulse string AB), at this point, the acceleration/deceleration time is determined by the acceleration/deceleration time of the VFD, meanwhile, the parameters of pulse string AB is still set by P21 group. In speed mode, the filter time of pulse string AB is determined by P21.29.

Step 8: The input frequency of pulse string is the same with the feedback frequency of encoder pulse, the relation between them can be changed by altering P21.11 (numerator of position command ratio) and P21.12 (denominator of position command ratio)

Step 9: When running command or servo enabling is valid (by setting P21.00 or terminal function 63), it will enter pulse string servo running mode.

4. Commissioning procedures for spindle positioning

Spindle orientation is to realize orientation functions like zeroing and division based on closed-loop vector control

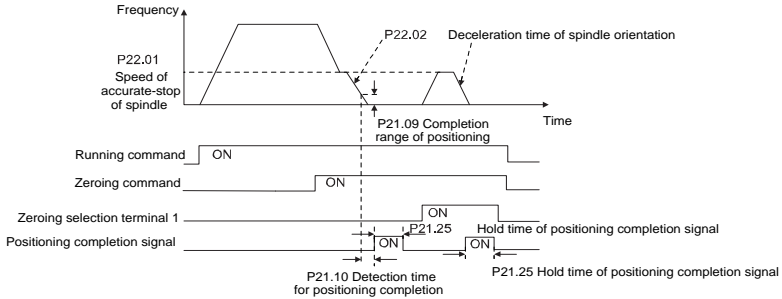

Step 1–4: These four steps are the same with the first four steps of the commissioning procedures for closed-loop vector control, which aim to fulfill the control requirements of closed-loop vector control, thus realizing spindle positioning function in either position control or speed control mode.

Step 5: Set P22.00.bit0=1 to enable spindle positioning, set P22.00.bit1 to select spindle zero input. If the system adopts encoder for speed measurement, set P22.00.bit1 to 0 to select Z pulse input; if the system adopts photoelectric switch for speed measurement, set P22.00.bit1 to 1 to select photoelectric switch as zero input; set P22.00.bit2 to select zero search mode, set P22.00.bit3 to enable or disable zero calibration, and select zero calibration mode by setting P22.00.bit7.

Step 6: Spindle zeroing operation

- a) Select the positioning direction by setting P22.00.bit4;
- b) There are four zero positions in P22 group, users can choose one out of four zeroing positions by setting zeroing input terminal selection (46, 47) in P05 group. When executing zeroing function, the motor will stop accurately at corresponding zeroing position according to the set positioning direction, which can be viewed via P18.10;
- c) The positioning length of spindle zeroing is determined by the deceleration time of accurate-stop and the speed of accurate-stop;

Step 7: Spindle division operation

There are seven scale-division positions in P22 group, users can choose one out of seven scale-division positions by setting scale-division input terminal selection (48, 49, 50) in P05 group. Enable corresponding scale-division terminal after the motor stops accurately, and the motor will check the scale-division position state and switch to corresponding position incrementally, at this point, users can check P18.09.

Step 8: Priority level of speed control, position control and zeroing

The priority level of speed running is higher than that of the scale division, when the system runs in scale-division mode, if spindle orientation is prohibited, the motor will turn to speed mode or position mode.

The priority level of zeroing is higher than that of the scale division.

Scale-division command is valid when the scale-division terminal is from 000 state to non-000 state, eg, in 000–011, the spindle executes scale division 3. The transition time during terminal switch-over needs to be less than 10ms; otherwise, wrong scale division command may be executed.

Step 9: Hold positioning

The position loop gain during positioning is P21.03; while the position loop gain in positioning-completion-hold state is P21.02. In order to keep sufficient position-hold force and ensure no system oscillation occurred, adjust P03.00, P03.01, P20.05 and P21.02.

Step 10: Positioning command selection (bit6 of P22.00)

Electric level signal: Positioning command (zeroing and scale division) can be executed only when there is running command or the servo is enabled.

Step 11: Spindle reference point selection (bit0 of P22.00)

Encoder Z pulse positioning supports the following spindle positioning modes:

- a) the encoder is installed on the motor shaft, the motor shaft and spindle is 1:1 rigid connection;
- b) the encoder is installed on the motor shaft, the motor shaft and spindle is 1:1 belt connection;

At this point, the belt may slip during high-speed running and cause inaccurate positioning, it is recommended to install proximity switch on the spindle.

- c) The encoder is installed on the spindle, and the motor shaft is connected to the spindle with belt, the drive ratio is not necessarily 1:1;

At this point, set P20.06 (speed ratio of the mounting shaft between motor and encoder), and set P22.14 (spindle drive ratio) to 1. As the encoder is not installed on the motor, the control performance of closed-loop vector will be affected.

Proximity switch positioning supports the following spindle positioning modes:

- a) The encoder is installed on the motor shaft, the drive ratio between motor shaft and spindle is not necessarily 1:1;

At this point, it is required to set P22.14 (spindle drive ratio).

5. Commissioning procedures for digital positioning

The diagram for digital positioning is shown below.

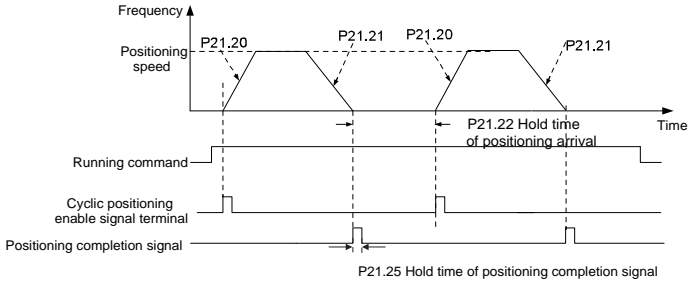

Step 1–4: These four steps are the same with the first four steps of the commissioning procedures for closed-loop vector control, which aim to fulfill the control requirements of closed-loop vector control.

Step 5: Set P21.00=0011 to enable digital positioning. Set P21.17, P21.11 and P21.12 (set positioning displacement) according to actual needs ; set P21.18 and P21.19 (set positioning speed); set P21.20 and P21.21 (set acceleration/deceleration time of positioning).

Step 6: Single positioning operation

Set P21.16.bit1=0, and the motor will carry out single positioning action and stay in the positioning position according to the setup in step 5.

Step 7: Cyclic positioning operation

Set P21.16.bit1=1 to enable cyclic positioning. The cyclic positioning is divided into continuous mode and repetitive mode; users can also carry out cyclic positioning through terminal function (no. 55, enable digital positioning cycle)

6. Commissioning procedures for positioning of photoelectric switch

Photoelectric switch positioning is to realize positioning function based on closed-loop vector control.

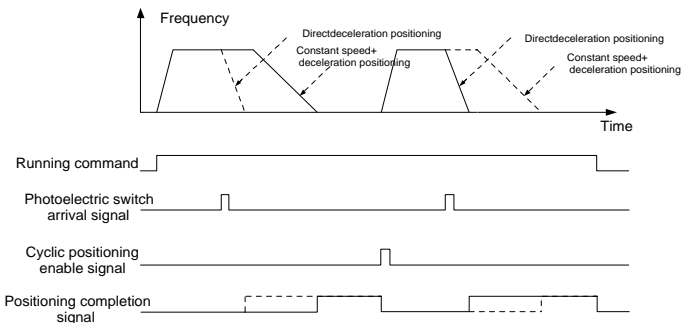

Step 1–4: These four steps are the same with the first four steps of the commissioning procedures for closed-loop vector control, which aim to fulfill the control requirements of closed-loop vector control.

Step 5: Set P21.00=0021 to enable photoelectric switch positioning, the photoelectric switch signal

can be connected to S8 terminal only, and set P05.08=43, meanwhile, set P21.17, P21.11 and P21.12 (set positioning displacement) based on actual needs; set P21.21 (deceleration time of positioning), however, when present running speed is too fast or the set positioning displacement is too small, the deceleration time of positioning will be invalid, and it will enter direct deceleration positioning mode.

Step 6: Cyclic positioning

After positioning is done, the motor will stay in current position. Users can set cyclic positioning through input terminal function selection (55: enable cyclic digital positioning) in P05 group; when the terminal receives cyclic positioning enable signal (pulse signal), the motor will continue running in the set speed as per the speed mode and re-enter positioning state after encountering photoelectric switch.

(7) Hold positioning

The position loop gain during positioning is P21.03; while the position loop gain in positioning-completion-hold state is P21.02. In order to keep sufficient position-hold force and ensure no system oscillation occurred, adjust P03.00, P03.01, P20.05 and P21.02.

5.5.19 Fault handling

GD350 series VFD provides abundant information concerning fault handling for the convenience of the users.

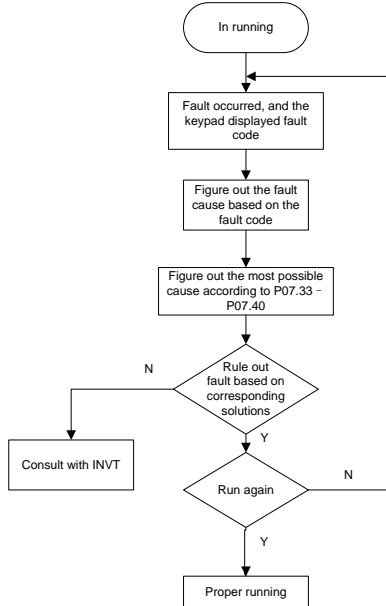

Related parameter list:

Function code	Name	Detailed parameter description	Default value
P07.27	Type of present fault	0: No fault	0
P07.28	Type of the last fault	1: Inverter unit U phase protection (OUt1)	/
P07.29	Type of the last but one fault	2: Inverter unit V phase protection (OUt2)	/
P07.30	Type of the last but two fault	3: Inverter unit W phase protection (OUt3)	/
P07.31	Type of the last but three fault	4: Overcurrent during acceleration (OC1) 5: Overcurrent during deceleration (OC2) 6: Overcurrent during constant speed (OC3) 7: Overvoltage during acceleration (OV1) 8: Overvoltage during deceleration (OV2) 9: Overvoltage during constant speed (OV3) 10: Bus undervoltage fault (UV) 11: Motor overload (OL1) 12: VFD overload (OL2) 13: Phase loss on input side (SPI) 14: Phase loss on output side (SPO) 15: Rectifier module overheat (OH1) 16: Inverter module overheat (OH2) 17: External fault (EF)	/
P07.32	Type of the last but four fault	18: 485 communication fault (CE) 19: Current detection fault (ItE) 20: Motor autotuning fault (tE) 21: EEPROM operation fault (EEP) 22: PID feedback offline fault (PIDE) 23: Brake unit fault (bCE) 24: Running time reached (END) 25: Electronic overload (OL3) 26: Keypad communication error (PCE) 27: Parameter upload error (UPE) 28: Parameter download error (DNE) 29: PROFIBUS DP communication fault (E-DP) 30: Ethernet communication fault (E-NET)	

Function code	Name	Detailed parameter description	Default value
		31: CANopen communication fault (E-CAN) 32: To-ground short-circuit fault 1 (ETH1) 33: To-ground short-circuit fault 2 (ETH2) 34: Speed deviation fault (dEu) 35: Mal-adjustment fault (STo) 36: Underload fault (LL) 37: Encoder offline fault (ENC1O) 38: Encoder reversal fault (ENC1D) 39: Encoder Z pulse offline fault (ENC1Z) 40: Safe torque off (STO) 41: Channel H1 safety circuit exception (STL1) 42: Channel H2 safety circuit exception (STL2) 43: Channel H1 and H2 exception (STL3) 44: Safety code FLASH CRC check fault (CrCE) 55: Repetitive extension card type fault (E-Err) 56: Encoder UVW loss fault (ENCUV) 57: PROFINET communication timeout fault (E-PN) 58: CAN communication fault (SECAN) 59: Motor over-temperature fault (OT) 60: Card slot 1 card identification failure (F1-Er) 61: Card slot 2 card identification failure (F2-Er) 62: Card slot 3 card identification failure (F3-Er) 63: Card slot 1 card communication timeout fault (C1-Er) 64: Card slot 2 card communication timeout fault (C2-Er) 65: Card slot 3 card communication timeout fault (C3-Er) 66: EtherCAT communication fault	

Function code	Name	Detailed parameter description	Default value
		(E-CAT) 67: Bacnet communication fault (E-BAC) 68: DeviceNet communication fault (E-DEV) 69: Master-slave synchronous CAN slave fault (S-Err)	
P07.33	Running frequency of present fault	0.00Hz~P00.03	0.00Hz
P07.34	Ramps reference frequency of present fault	0.00Hz~P00.03	0.00Hz
P07.35	Output voltage of present fault	0~1200V	0V
P07.36	Output current of present fault	0.0~6300.0A	0.0A
P07.37	Bus voltage of present fault	0.0~2000.0V	0.0V
P07.38	Max. temperature of present fault	-20.0~120.0°C	0.0°C
P07.39	Input terminal state of present fault	0x0000~0xFFFF	0
P07.40	Output terminal state of present fault	0x0000~0xFFFF	0
P07.41	Running frequency of the last fault	0.00Hz~P00.03	0.00Hz
P07.42	Ramps reference frequency of the last fault	0.00Hz~P00.03	0.00Hz
P07.43	Output voltage of the last fault	0~1200V	0V
P07.44	Output current of the last fault	0.0~6300.0A	0.0A
P07.45	Bus voltage of the last fault	0.0~2000.0V	0.0V
P07.46	Max. temperature of the last fault	-20.0~120.0°C	0.0°C
P07.47	Input terminal state of the last fault	0x0000~0xFFFF	0
P07.48	Output terminal state of the last fault	0x0000~0xFFFF	0
P07.49	Running frequency of the last but one fault	0.00Hz~P00.03	0.00Hz

Function code	Name	Detailed parameter description	Default value
P07.50	Ramps reference frequency of the last but one fault	0.00Hz~P00.03	0.00Hz
P07.51	Output voltage of the last but one fault	0~1200V	0V
P07.52	Output current of the last but one fault	0.0~6300.0A	0.0A
P07.53	Bus voltage of the last but one fault	0.0~2000.0V	0.0V
P07.54	Max. temperature of the last but one fault	-20.0~120.0°C	0.0°C
P07.55	Input terminal state of the last but one fault	0x0000~0xFFFF	0
P07.56	Output terminal state of the last but one fault	0x0000~0xFFFF	0

6 Function parameter list

6.1 What this chapter contains

This chapter lists all the function codes and corresponding description of each function code.

6.2 Function parameter list

Function parameters of the GD350 IP54 series VFD are categorized according to functions. Among the function groups, P98 is analog input/output calibration group, and P99 is factory function group which cannot be accessed by users. The function code adopts three-level menu, eg, "P08.08" indicates it is the no. 8 function code in P8 group.

The function group no. corresponds to the first-level menu; function code no. corresponds to the second-level menu; function code parameter corresponds to the third-level menu.

1. The function list is divided into the following columns.

Column 1 "Function code": number of the function parameter group and the parameter;

Column 2 "Name": complete name of the function parameter;

Column 3 "Detailed parameter description": detailed description of this function parameter;

Column 4 "Default value": The original set value of the function parameter by default;

Column 5: "Modify": The modification attribute of the function parameter, namely whether the function parameter can be modified and the condition for modification, as shown below.

"○": the set value of this parameter can be modified when the VFD is in stop or running state;

"◎": the set value of this parameter cannot be modified when the VFD is in running state;

"●": the parameter value is the measured value which cannot be modified.

(The VFD has assigned the modification attribute of each parameter automatically to avoid inadvertent modification by users.)

2. "System of numeration for parameters" is decimalism; if the parameter is presented in hexadecimal numbers, the data of each bit will be independent of each other during parameter edit, and the value range of partial bits can be 0–F in hexadecimal system.
3. "Default value" is value restored after parameter refresh during restoring to default value; however, the measured value or recorded value will not be refreshed.
4. In order to enhance parameter protection, the VFD provides password protection for the function codes. After setting user password (namely user password P07.00 is not zero), when users press **PRG/ESC** key to enter function code edit state, the system will first enter user password verification state which displays "0.0.0.0.0.", requiring operators to input the correct user password. For factory parameters, besides user password, it is also required to input the correct factory password (users should not attempt to modify factory parameters as improper setup may easily lead to mal-operation or damage the VFD). When password protection is unlocked, the user password can

be modified at any time; user password is subject to the last input. User password can be cancelled by setting P07.00 to 0; if P01.00 is set to a non-zero value, the parameter will be protected by password. When modifying function parameters through serial communication, the function of user password also follows above rules.

P00—Basic functions

Function code	Name	Detailed parameter description	Default value	Modify
P00.00	Speed control mode	0: SVC 0 1: SVC 1 2: SVPWM 3: VC Note: If 0, 1 or 3 is selected, it is required to carry out motor parameter autotuning first.	2	☉
P00.01	Running command channel	0: Keypad 1: Terminal 2: Communication	0	○
P00.02	Communication running command channel	0: Modbus 1: PROFIBUS/CANopen/DeviceNet 2: Ethernet 3: EtherCAT/PROFINET 4: PLC programmable card 5: Wireless communication card Note: 1, 2, 3, 4 and 5 are extended functions which are applicable with corresponding cards.	0	○
P00.03	Max. output frequency	Used to set the max. output frequency of the VFD. It is the basis of frequency setup and the acceleration/deceleration. Setting range: Max (P00.04 , 10.00) –630.00Hz	50.00Hz	☉
P00.04	Upper limit of running frequency	The upper limit of running frequency is upper limit value of VFD output frequency. This value should be no more than the max. output frequency. When the set frequency is higher than the upper limit frequency, the VFD runs at the upper limit frequency. Setting range: P00.05 – P00.03 (max. output frequency)	50.00Hz	☉
P00.05	Lower limit of running frequency	The lower limit of running frequency is the lower limit value of VFD output frequency. When the set frequency is lower than the lower	0.00Hz	☉

Function code	Name	Detailed parameter description	Default value	Modify
		limit frequency, the VFD runs at the lower limit frequency. Note: Max. output frequency \geq upper limit frequency \geq lower limit frequency. Setting range: 0.00Hz– P00.04 (upper limit of running frequency)		
P00.06	A frequency command selection	0: Set via keypad 1: Set via AI1 2: Set via AI2	0	<input type="radio"/>
P00.07	B frequency command selection	3: Set via AI3 4: Set via high speed pulse HDIA 5: Set via simple PLC program 6: Set via multi-step speed running 7: Set via PID control 8: Set via Modbus communication 9: Set via PROFIBUS/CANopen/DeviceNet communication 10: Set via Ethernet communication 11: Set via high speed pulse HDIB 12: Set via pulse string AB 13: Set via EtherCAT/PROFINET communication 14: Set via PLC card 15: Reserved	15	<input type="radio"/>
P00.08	Reference object of B frequency command	0: Max. output frequency 1: A frequency command	0	<input type="radio"/>
P00.09	Combination mode of setting source	0: A 1: B 2: (A+B) 3: (A-B) 4: Max. (A, B) 5: Min. (A, B)	0	<input type="radio"/>
P00.10	Set frequency via keypad	When A and B frequency commands are set by keypad, the value is the initial digital set value of the VFD frequency. Setting range: 0.00 Hz– P00.03 (max. output frequency)	50.00Hz	<input type="radio"/>

Function code	Name	Detailed parameter description	Default value	Modify																										
P00.11	Acceleration time 1	Acceleration time is the time needed for accelerating from 0Hz to max. output frequency	Depends on model	<input type="radio"/>																										
P00.12	Deceleration time 1	Deceleration time is the time needed from decelerating from max. output frequency (P00.03) to 0Hz. The Goodrive350 IP54 high-ingress protection series VFD defines four groups of acceleration and deceleration time, which can be selected via multi-function digital input terminals (P05 group). The acceleration/deceleration time of the VFD is the first group by default. Setting range of P00.11 and P00.12: 0.0–3600.0s	Depends on model	<input type="radio"/>																										
P00.13	Running direction	0: Run in default direction 1: Run in reverse direction 2: Reverse running is prohibited	0	<input type="radio"/>																										
P00.14	Carrier frequency setup	<table border="1"> <thead> <tr> <th>Carrier frequency</th> <th>Electro magnetic noise</th> <th>Noise and leakage current</th> <th>Cooling level</th> </tr> </thead> <tbody> <tr> <td>1kHz</td> <td>↑ High</td> <td>↑ Low</td> <td>↑ Low</td> </tr> <tr> <td>10kHz</td> <td>↕</td> <td>↕</td> <td>↕</td> </tr> <tr> <td>15kHz</td> <td>↓ Low</td> <td>↓ High</td> <td>↓ High</td> </tr> </tbody> </table> <p>The relation between the model and carrier frequency is shown below.</p> <table border="1"> <thead> <tr> <th colspan="2">Model</th> <th>Default value of carrier frequency</th> </tr> </thead> <tbody> <tr> <td rowspan="3">380V</td> <td>004G/5R5P-011G/015P</td> <td>8kHz</td> </tr> <tr> <td>015G/018P-055G/075P</td> <td>4kHz</td> </tr> <tr> <td>075G/090P and higher</td> <td>2kHz</td> </tr> </tbody> </table> <p>Advantages of high carrier frequency are as follows: ideal current waveform, few current harmonics and small motor noise.</p>	Carrier frequency	Electro magnetic noise	Noise and leakage current	Cooling level	1kHz	↑ High	↑ Low	↑ Low	10kHz	↕	↕	↕	15kHz	↓ Low	↓ High	↓ High	Model		Default value of carrier frequency	380V	004G/5R5P-011G/015P	8kHz	015G/018P-055G/075P	4kHz	075G/090P and higher	2kHz	Depends on model	<input type="radio"/>
Carrier frequency	Electro magnetic noise	Noise and leakage current	Cooling level																											
1kHz	↑ High	↑ Low	↑ Low																											
10kHz	↕	↕	↕																											
15kHz	↓ Low	↓ High	↓ High																											
Model		Default value of carrier frequency																												
380V	004G/5R5P-011G/015P	8kHz																												
	015G/018P-055G/075P	4kHz																												
	075G/090P and higher	2kHz																												

Function code	Name	Detailed parameter description	Default value	Modify
		<p>Disadvantages of high carrier frequency are as follows: growing switch consumption, enlarged temperature rise, impacted output capacity; under high carrier frequency, the VFD needs to be derated for use, meanwhile, the leakage current will increase, which increases electromagnetic interference to the surroundings.</p> <p>While low carrier frequency is the contrary. Low carrier frequency will cause unstable operation at low frequency, decrease the torque, or even lead to oscillation.</p> <p>The carrier frequency of VFD is set properly by default, and it should not be changed by users at will.</p> <p>If the default carrier frequency is exceeded during use, derating is required, derate by 10% for every additional 1k carrier frequency.</p> <p>Setting range: 1.2–15.0kHz</p>		
P00.15	Motor parameter autotuning	<p>0: No operation</p> <p>1: Rotary autotuning 1; carry out comprehensive motor parameter autotuning; rotary autotuning is used in cases where high control precision is required;</p> <p>2: Static autotuning 1 (comprehensive autotuning); static autotuning 1 is used in cases where the motor cannot be disconnected from load;</p> <p>3: Static autotuning 2 (partial autotuning) ; when current motor is motor 1, only P02.06, P02.07 and P02.08 will be autotuned; when current motor is motor 2, only P12.06, P12.07 and P12.08 will be autotuned.</p> <p>4: Rotary autotuning 2, which is similar to rotary autotuning 1 but is only applicable to asynchronous motors.</p> <p>5: Rotary autotuning 3 (partial autotuning), which is only applicable to asynchronous motors.</p>	0	⊙
P00.16	AVR function	<p>0: Invalid</p> <p>1: Valid during the whole process</p>	1	○

Function code	Name	Detailed parameter description	Default value	Modify
		Automatic voltage regulation function is used to eliminate the impact on the output voltage of VFD when bus voltage fluctuates.		
P00.17	VFD model	0: G model 1: P model		
P00.18	Function parameter restoration	0: No operation 1: Restore to default value 2: Clear fault history Note: After the selected function operations are done, this function code will be restored to 0 automatically. Restoration to default value will clear the user password. This function should be used with caution.	0	⊙

P01—Start/stop control

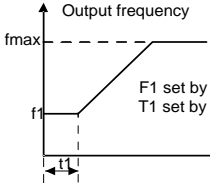
Function code	Name	Detailed parameter description	Default value	Modify
P01.00	Running mode of start	0: Direct start 1: Start after DC brake 2: Start after speed-tracking 1 3: Start after speed-tracking 2	0	⊙
P01.01	Starting frequency of direct start	Starting frequency of direct startup is the initial frequency when the VFD starts. See P01.02 (hold time of starting frequency) for details. Setting range: 0.00–50.00Hz	0.50Hz	⊙
P01.02	Hold time of starting frequency	 <p>A proper starting frequency can increase the torque during startup. Within the hold time of starting frequency, the output frequency of VFD is the starting frequency, and then it runs from the starting frequency to the target frequency, if the target frequency (frequency command) is below the</p>	0.0s	⊙

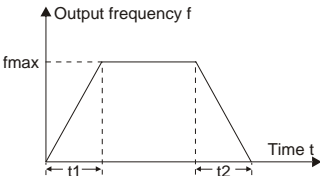
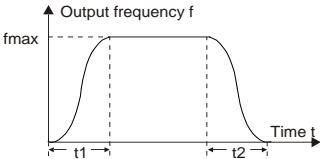
Function code	Name	Detailed parameter description	Default value	Modify
		starting frequency, the VFD will be standby rather than running. The starting frequency value is unlimited by the lower limit frequency. Setting range: 0.0–50.0s		
P01.03	DC brake current before start	During starting, the VFD will first perform DC brake based on the set DC brake current before startup, and then it will accelerate after the set DC brake time before startup elapses. If the set DC brake time is 0, DC brake will be invalid.	0.0%	☉
P01.04	DC brake time before start	The larger the DC brake current, the stronger the brake force. The DC brake current before startup refers to the percentage relative to rated VFD current. Setting range of P01.03 : 0.0–100.0% Setting range of P01.04 : 0.00–50.00s	0.00s	☉
P01.05	Acceleration/deceleration mode	<p>This function code is used to select the frequency variation mode during starting and running.</p> <p>0: Straight line; the output frequency increases or decreases in straight line;</p>  <p>1: S curve; the output frequency increases or decreases in S curve;</p> <p>S curve is generally used in cases where smooth start/stop is required, eg, elevator, conveyer belt, etc.</p>  <p>Note: When set to 1, it is required to set P01.06, P01.07, P01.27 and P01.28 accordingly.</p>	0	☉

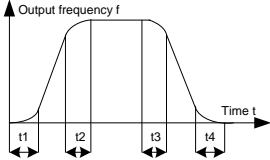
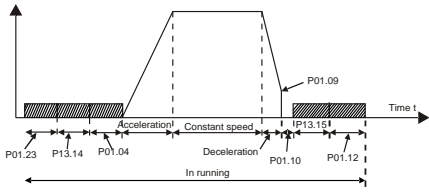
Function code	Name	Detailed parameter description	Default value	Modify
P01.06	Time of starting section of acceleration S curve	The curvature of S curve is determined by acceleration range and acceleration and deceleration time.  <p style="text-align: right;"> t1=P01.06 t2=P01.07 t3=P01.27 t4=P01.28 </p>	0.1s	☉
P01.07	Time of ending section of acceleration S curve		Setting range: 0.0–50.0s	0.1s
P01.08	Stop mode	0: Decelerate to stop; after stop command is valid, the VFD lowers output frequency based on the deceleration mode and the defined deceleration time, after the frequency drops to the stop speed (P01.15), the VFD stops. 1: Coast to stop; after stop command is valid, the VFD stops output immediately, and the load coasts to stop as per mechanical inertia.	0	○
P01.09	Starting frequency of DC brake after stop	Starting frequency of DC brake after stop; during decelerating to stop, when this frequency is reached, DC brake will be performed after stop.	0.00Hz	○
P01.10	Waiting time of DC brake after stop	Demagnetization time (waiting time of DC brake after stop): Before the DC brake, the VFD will block output, and after the demagnetization time elapses, DC brake will start. This function is used to prevent overcurrent fault caused by DC brake during high speed.	0.00s	○
P01.11	DC brake current of stop	DC brake current after stop: it means the DC brake force applied, the larger the current, the stronger the DC brake effect.	0.0%	○
P01.12	DC brake time of stop	 <p>Setting range of P01.09: 0.00Hz–P00.03 (max. output frequency)</p>	0.00s	○

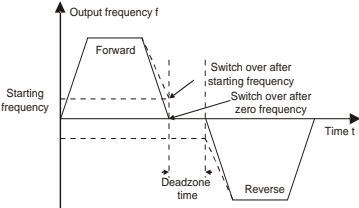
Function code	Name	Detailed parameter description	Default value	Modify
		Setting range of P01.10 : 0.00–30.00s Setting range of P01.11 : 0.0–100.0% Setting range of P01.12 : 0.0–50.0s		
P01.13	Deadzone time of forward/reverse rotation	This function code refers to the transition time of the threshold set by P01.14 during setting forward/reverse rotation of the VFD, as shown below.  Setting range: 0.0–3600.0s	0.0s	○
P01.14	Forward/reverse rotation switch-over mode	0: Switch over after zero frequency 1: Switch over after starting frequency 2: Switch over after passing stop speed and delay	1	◎
P01.15	Stop speed	0.00–100.00Hz	0.50Hz	◎
P01.16	Stop speed detection mode	0: Set value of speed (the only detection mode valid in SVPWM mode) 1: Detection value of speed	0	◎
P01.17	Stop speed detection time	0.00–100.00s	0.50s	◎
P01.18	Running protection of power-on terminal	When the running command channel is controlled by terminals, the system will detect running terminal state automatically during power up. 0: Terminal running command is invalid during power up. The VFD will not run during power up even if the running command terminal is detected to be valid, and the system is in running protection state. The VFD will run only after this terminal is cancelled and enabled again. 1: Terminal running command is valid during power up. The system will start the VFD automatically after initialization is done if the running command terminal is detected to be valid during power up.	0	○

Function code	Name	Detailed parameter description	Default value	Modify
		Note: This function must be set with caution, otherwise, serious consequences may occur.		
P01.19	Action selection when the running frequency is below lower limit (lower limit should be larger than 0)	<p>This function code is used to set the running state of VFD when the set frequency is below lower limit frequency.</p> <p>0: Run in lower limit of the frequency 1: Stop 2: Sleep</p> <p>When the set frequency is below lower limit frequency, the VFD coasts to stop; when the set frequency is above lower limit again and continues to be so after the time set by P01.20 elapses, the VFD will be restored to running state automatically.</p>	0	⊙
P01.20	Wake-up-from-sleep delay	<p>This function code is used to set the sleep delay. When the running frequency of VFD is below the lower limit frequency, the VFD enters sleep state; when the set frequency is above the lower limit again and continues to be so after the time set by P01.20 elapses, the VFD will run automatically.</p> <p>Setting range: 0.0–3600.0s (valid when P01.19 is 2)</p>	0.0s	○
P01.21	Restart after power cut	<p>This function code sets the automatic running of the VFD at next power-on after power down.</p> <p>0: Disabled restart 1: Enable restart, namely the VFD will run automatically after the time set by P01.22 elapses if the starting conditions are met.</p>	0	○

Function code	Name	Detailed parameter description	Default value	Modify
P01.22	Waiting time of restart after power cut	<p>This function code sets the waiting time before automatically running at next power-on after power down.</p> <p>Setting range: 0.0–3600.0s (valid when P01.21 is 1)</p>	1.0s	<input type="radio"/>
P01.23	Start delay	<p>This function code sets the delay of the VFD's wake-up-from-sleep after running command is given, the VFD will start to run and output after the time set by P01.23 elapses to realize brake release.</p> <p>Setting range: 0.0–600.0s</p>	0.0s	<input type="radio"/>
P01.24	Stop speed delay	0.0–600.0s	0.0s	<input type="radio"/>
P01.25	Open-loop 0Hz output selection	0: No voltage output 1: With voltage output 2: Output as per DC brake current of stop	0	<input type="radio"/>
P01.26	Deceleration time of emergency-stop	0.0–60.0s	2.0s	<input type="radio"/>
P01.27	Time of starting section of deceleration S curve	0.0–50.0s	0.1s	<input checked="" type="radio"/>
P01.28	Time of ending section of deceleration S curve	0.0–50.0s	0.1s	<input checked="" type="radio"/>
P01.29	Short-circuit brake current	When the VFD starts in direct start mode (P01.00 =0), set P01.30 to a non-zero value to enter	0.0%	<input type="radio"/>
P01.30	Hold time of short-circuit brake at startup	short-circuit brake. During stop, if the running frequency of VFD is below the starting frequency of brake after stop (P01.09),	0.00s	<input type="radio"/>
P01.31	Hold time of short-circuit brake at stop	set P01.31 to a non-zero value to enter short-circuit brake after stop, and then carry out DC brake in the time set by P01.12 (refer to P01.09–P01.12).	0.00s	<input type="radio"/>

Function code	Name	Detailed parameter description	Default value	Modify
		Setting range of P01.29 : 0.0–150.0% (VFD) Setting range of P01.30 : 0.0–50.0s Setting range of P01.31 : 0.0–50.0s		
P01.32	Pre-exciting time of jogging	0–10.000s	0.000s	<input type="radio"/>
P01.33	Starting frequency of braking for jogging to stop	0–P00.03	0.00Hz	<input type="radio"/>
P01.34	Delay to enter sleep	0–3600.0s	0.0s	<input type="radio"/>

P02—Parameters of motor 1

Function code	Name	Detailed parameter description	Default value	Modify
P02.00	Type of motor 1	0: Asynchronous motor 1: Synchronous motor	0	<input checked="" type="radio"/>
P02.01	Rated power of asynchronous motor 1	0.1–3000.0kW	Depends on model	<input checked="" type="radio"/>
P02.02	Rated frequency of asynchronous motor 1	0.01Hz– P00.03 (max. output frequency)	50.00Hz	<input checked="" type="radio"/>
P02.03	Rated speed of asynchronous motor 1	1–60000rpm	Depends on model	<input checked="" type="radio"/>
P02.04	Rated voltage of asynchronous motor 1	0–1200V	Depends on model	<input checked="" type="radio"/>
P02.05	Rated current of asynchronous motor 1	0.8–6000.0A	Depends on model	<input checked="" type="radio"/>
P02.06	Stator resistance of asynchronous motor 1	0.001–65.535Ω	Depends on model	<input type="radio"/>
P02.07	Rotor resistance of asynchronous motor 1	0.001–65.535Ω	Depends on model	<input type="radio"/>

Function code	Name	Detailed parameter description	Default value	Modify
P02.08	Leakage inductance of asynchronous motor 1	0.1–6553.5Mh	Depends on model	<input type="radio"/>
P02.09	Mutual inductance of asynchronous motor 1	0.1–6553.5Mh	Depends on model	<input type="radio"/>
P02.10	No-load current of asynchronous motor 1	0.1–6553.5A	Depends on model	<input type="radio"/>
P02.11	Magnetic saturation coefficient 1 of iron core of asynchronous motor 1	0.0–100.0%	80.0%	<input type="radio"/>
P02.12	Magnetic saturation coefficient 2 of iron core of asynchronous motor 1	0.0–100.0%	68.0%	<input type="radio"/>
P02.13	Magnetic saturation coefficient 3 of iron core of asynchronous motor 1	0.0–100.0%	57.0%	<input type="radio"/>
P02.14	Magnetic saturation coefficient 4 of iron core of asynchronous motor 1	0.0–100.0%	40.0%	<input type="radio"/>
P02.15	Rated power of synchronous motor 1	0.1–3000.0kW	Depends on model	<input checked="" type="radio"/>

Function code	Name	Detailed parameter description	Default value	Modify
P02.16	Rated frequency of synchronous motor 1	0.01Hz– P00.03 (max. output frequency)	50.00Hz	☉
P02.17	Number of pole pairs of synchronous motor 1	1–128	2	☉
P02.18	Rated voltage of synchronous motor 1	0–1200V	Depends on model	☉
P02.19	Rated current of synchronous motor 1	0.8–6000.0A	Depends on model	☉
P02.20	Stator resistance of synchronous motor 1	0.001–65.535Ω	Depends on model	○
P02.21	Direct-axis inductance of synchronous motor 1	0.01–655.35Mh	Depends on model	○
P02.22	Quadrature-axis inductance of synchronous motor 1	0.01–655.35Mh	Depends on model	○
P02.23	Counter-emf constant of synchronous motor 1	0–10000	300	○
P02.24	Initial pole position of synchronous motor 1 (reserved)	0x0000–0xFFFF	0	●
P02.25	Identification current of synchronous motor 1 (reserved)	0%–50% (rated motor current)	10%	●

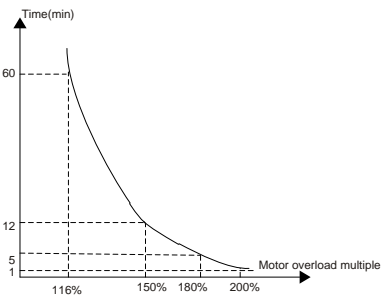
Function code	Name	Detailed parameter description	Default value	Modify
P02.26	Overload protection of motor 1	<p>0: No protection</p> <p>1: Common motor (with low-speed compensation). As the cooling effect of common motor will be degraded in low speed, the corresponding electronic thermal protection value should also be adjusted properly, the low compensation here means to lower the overload protection threshold of the motor whose running frequency is below 30Hz.</p> <p>2: Frequency-variable motor (without low speed compensation). As the cooling effect of frequency-variable motor is not affected by the rotating speed, there is no need to adjust the protection value during low speed running.</p>	2	☉
P02.27	Overload protection coefficient of motor 1	<p>Motor overload multiples $M = I_{out} / (I_n \times K)$</p> <p>$I_n$ is rated motor current, I_{out} is VFD output current, K is motor overload protection coefficient. The smaller the K, the larger the value of M, and the easier the protection.</p> <p>When $M=116\%$, protection is performed after motor overload lasts for 1 hour; when $M=150\%$, protection is performed after motor overload lasts for 12 minutes; when $M=180\%$, protection is performed after motor overload lasts for 5 minutes; when $M=200\%$, protection is performed after motor overload lasts for 60 seconds; and when $M \geq 400\%$, protection is performed immediately.</p>  <p>Setting range: 20.0%–120.0%</p>	100.0%	○

Function code	Name	Detailed parameter description	Default value	Modify
P02.28	Power display calibration coefficient of motor 1	This function adjusts the power display value of motor 1 only, and it does not affect the control performance of the VFD. Setting range: 0.00–3.00	1.00	<input type="radio"/>
P02.29	Parameter display of motor 1	0: Display as per motor type; under this mode, only parameters related to current motor type will be displayed. 1: Display all; under this mode, all the motor parameters will be displayed.	0	<input type="radio"/>
P02.30	System inertia of motor 1	0–30.000kgm ²	0	<input type="radio"/>
P02.31–P02.32	Reserved variables	0–65535	0	<input type="radio"/>

P03—Vector control of motor 1

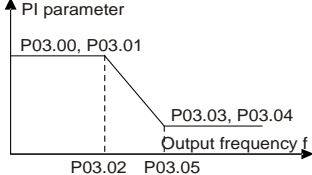
Function code	Name	Detailed parameter description	Default value	Modify
P03.00	Speed loop proportional gain 1	Parameters of P03.00–P03.05 fit for vector control mode only. Below P03.02 , speed loop PI parameter is P03.00 and P03.01 ; above P03.05 , speed loop PI parameter is P03.03 and P03.04 ; in between, PI parameter is obtained by linear variation between two groups of parameters, as shown below. 	20.0	<input type="radio"/>
P03.01	Speed loop integral time 1		0.200s	<input type="radio"/>
P03.02	Switch low point frequency		5.00Hz	<input type="radio"/>
P03.03	Speed loop proportional gain 2		20.0	<input type="radio"/>
P03.04	Speed loop integral time 2		0.200s	<input type="radio"/>
P03.05	Switch over high point frequency	The speed loop dynamic response characteristics of vector control can be adjusted by setting the proportional coefficient and integral time of speed regulator. Increase proportional gain or decrease integral time can accelerate dynamic response of speed loop, however, if the proportional gain is too large or integral time is too small, system oscillation and overshoot may occur; if	10.00Hz	<input type="radio"/>

Function code	Name	Detailed parameter description	Default value	Modify
		<p>proportional gain is too small, stable oscillation or speed offset may occur.</p> <p>Speed loop PI parameter is closely related to the system inertial, users should make adjustment based on default PI parameter according to different load characteristics to fulfill different needs.</p> <p>Setting range of P03.00:0.0–200.0; Setting range of P03.01: 0.000–10.000s Setting range of P03.02: 0.00Hz–P03.05 Setting range of P03.03: 0.0–200.0 Setting range of P03.04: 0.000–10.000s Setting range of P03.05: P03.02–P00.03 (max. output frequency)</p>		
P03.06	Speed loop output filter	0–8 (corresponds to 0–2 ⁸ /10ms)	0	<input type="radio"/>
P03.07	Vector control slip compensation coefficient (motoring)	Slip compensation coefficient is used to adjust the slip frequency of vector control to improve speed control precision. This parameter can be used to control speed offset.	100%	<input type="radio"/>
P03.08	Vector control slip compensation coefficient (generating)	Setting range: 50–200%	100%	<input type="radio"/>
P03.09	Current loop proportional coefficient P	Note: 1. These two parameters are used to adjust PI parameters of current loop; it affects dynamic response speed and control precision of the system directly. The default value needs no adjustment under common conditions;	1000	<input type="radio"/>
P03.10	Current loop integral coefficient I	2. Fit for SVC mode 0 (P00.00 =0), SVC mode 1 (P00.00 =1) and VC mode (P00.00 =3); Setting range: 0–65535	1000	<input type="radio"/>
P03.11	Torque setup mode selection	1: Keypad (P03.12) 2: AI1 3: AI2 4: AI3	1	<input type="radio"/>

Function code	Name	Detailed parameter description	Default value	Modify
		5: Pulse frequency HDIA 6: Multi-step torque 7: Modbus communication 8: PROFIBUS/CANopen/DeviceNet communication 9: Ethernet communication 10: Pulse frequency HDIB 11: EtherCAT/PROFINET communication 12: PLC Note: For setting sources 2–6 and 10, 100% corresponds to three times the rated motor current.		
P03.12	Torque set by keypad	-300.0%–300.0% (rated motor current)	20.0%	<input type="radio"/>
P03.13	Torque reference filter time	0.000–10.000s	0.010s	<input type="radio"/>
P03.14	Source of upper limit frequency setup of forward rotation in torque control	0: Keypad (P03.16) 1: AI1 (100% corresponds to max. frequency) 2: AI2 (the same as above) 3: AI3 (the same as above) 4: Pulse frequency HDIA (the same as above) 5: Multi-step (the same as above) 6: Modbus communication (the same as above) 7: PROFIBUS/CANopen/DeviceNet communication (the same as above) 8: Ethernet communication (the same as above) 9: Pulse frequency HDIB (the same as above) 10: EtherCAT/PROFINET communication 11: PLC 12: Reserved	0	<input type="radio"/>
P03.15	Source of upper limit frequency setup of reverse rotation in torque control	0: Keypad (P03.17) 1: AI1 (100% corresponds to max. frequency) 2: AI2 (the same as above) 3: AI3 (the same as above) 4: Pulse frequency HDIA (the same as above) 5: Multi-step (the same as above) 6: Modbus communication (the same as above)	0	<input type="radio"/>

Function code	Name	Detailed parameter description	Default value	Modify
		7: PROFIBUS/CANopen/DeviceNet communication (the same as above) 8: Ethernet communication (the same as above) 9: Pulse frequency HDIB (the same as above) 10: EtherCAT/PROFINET communication 11: PLC 12: Reserved Note: Source 1-11, 100% relative to the max. frequency		
P03.16	Keypad limit value of upper limit frequency of forward rotation in torque control	This function code is used to set frequency limit. 100% corresponds to the max. frequency. P03.16 sets the value when P03.14 =1; P03.17 sets the value when P03.15 =1. Setting range: 0.00Hz– P00.03 (max. output frequency)	50.00Hz	<input type="radio"/>
P03.17	Max. output frequency		50.00Hz	<input type="radio"/>
P03.18	Source of upper limit setup of the torque during motoring	0: Keypad (P03.20) 1: AI1 2: AI2 3: AI3 4: Pulse frequency HDIA 5: Modbus communication 6: PROFIBUS/CANopen/DeviceNet communication 7: Ethernet communication 8: Pulse frequency HDIB 9: EtherCAT/PROFINET communication 10: PLC 11: Reserved Note: For setting sources 1–4 and 8, 100% corresponds to three times the rated motor current.	0	<input type="radio"/>
P03.19	Source of upper limit setup of brake torque	0: Keypad (P03.21) 1–10: the same as P03.18	0	<input type="radio"/>
P03.20	Set upper limit of the torque when	This function code is used to set torque limit. Setting range: 0.0–300.0% (rated motor current)	180.0%	<input type="radio"/>

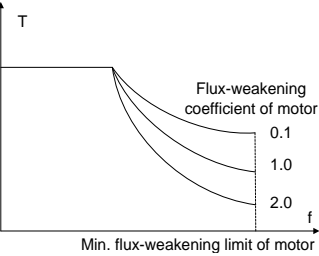
Function code	Name	Detailed parameter description	Default value	Modify
	motoring via keypad			
P03.21	Set upper limit of brake torque via keypad		180.0%	<input type="radio"/>
P03.22	Flux-weakening coefficient of constant-power zone	Used when asynchronous motor is in flux-weakening control. 	0.3	<input type="radio"/>
P03.23	Min. flux-weakening point of constant-power zone	P03.22 and P03.23 are valid during constant power. When motor speed is above rated speed, motor enters flux-weakening running state. The flux-weakening control coefficient can change the flux-weakening curvature, the larger the coefficient, the steeper the curve, the smaller the coefficient, the smoother the curve. Setting range of P03.22 : 0.1–2.0 Setting range of P03.23 : 10%–100%	20%	<input type="radio"/>
P03.24	Max. voltage limit	P03.24 sets the max. output voltage of the VFD, which is the percentage of rated motor voltage. This value should be set according to field conditions. Setting range:0.0–120.0%	100.0%	<input type="radio"/>
P03.25	Pre-exciting time	Carry out motor pre-exciting during starting to build a magnetic field inside the motor to improve the torque characteristics of motor during starting. Setting range: 0.000–10.000s	0.300s	<input type="radio"/>
P03.26	Flux-weakening proportional gain	0–8000	1000	<input type="radio"/>
P03.27	Vector control speed display	0: Display as per actual value 1: Display as per the set value	0	<input type="radio"/>

Function code	Name	Detailed parameter description	Default value	Modify
P03.28	Static friction compensation coefficient	0.0–100.0%	0.0%	<input type="radio"/>
P03.29	Corresponding frequency point of static friction	0.50– P03.31	1.00Hz	<input type="radio"/>
P03.30	High speed friction compensation coefficient	0.0–100.0%	0.0%	<input type="radio"/>
P03.31	Corresponding frequency of high speed friction torque	P03.29 –400.00Hz	50.00Hz	<input type="radio"/>
P03.32	Torque control enable	0:Disable 1:Enable	0	<input checked="" type="radio"/>
P03.33	Flux weakening integral gain	0–8000	1200	<input type="radio"/>
P03.34	Reserved	0–65535	0	<input checked="" type="radio"/>
P03.35	Control optimization setting	0–0x1111 Ones place: Torque command selection 0: Torque reference 1: Torque current reference Tens place: Reserved 0: Reserved 1: Reserved Hundreds place: Whether to enable ASR integral separation 0: Disable 1: Enable Thousands place: Reserved 0: Reserved 1: Reserved	0x0000	<input type="radio"/>
P03.36	Speed loop differential gain	0.00–10.00s	0.00s	<input type="radio"/>
P03.37	High-frequency current loop	Under closed-loop vector control mode (P00.00 =3) and P03.39 , the current loop PI parameters are	1000	<input type="radio"/>

Function code	Name	Detailed parameter description	Default value	Modify
	proportional coefficient	P03.09 and P03.10 ; above P03.39 , the PI parameters are P03.37 and P03.38 .		
P03.38	High-frequency current loop integral coefficient	Setting range of P03.37 : 0–65535 Setting range of P03.38 : 0–65535 Setting range of P03.39 : 0.0–100.0% (relative to max. frequency)	1000	<input type="radio"/>
P03.39	Current loop high-frequency switch-over point		100.0%	<input type="radio"/>
P03.40	Inertia compensation enable	0: Disable 1: Enable	0	<input type="radio"/>
P03.41	Upper limit of inertia compensation torque	Limit the max. inertia compensation torque to prevent inertia compensation torque from being too large. Setting range: 0.0–150.0% (rated motor torque)	10.0%	<input type="radio"/>
P03.42	Inertia compensation filter times	Filter times of inertia compensation torque, used to smooth inertia compensation torque. Setting range: 0–10	7	<input type="radio"/>
P03.43	Inertia identification torque value	Due to friction force, it is required to set certain identification torque for the inertia identification to be performed properly. 0.0–100.0% (rated motor torque)	10.0%	<input type="radio"/>
P03.44	Enable inertia identification	0: No operation 1: Start identification	0	<input checked="" type="radio"/>
P03.45	Current loop proportional coefficient after autotuning	Automatic update will be performed after motor parameter autotuning. In the closed-loop vector control mode for synchronous motors, you can set the value of this function code to P03.09. Range: 0–65535 Note: Set the value to 0 if motor parameter autotuning is not performed.	0	<input checked="" type="radio"/>
P03.46	Current integral proportional coefficient after autotuning	Automatic update will be performed after motor parameter autotuning. In the closed-loop vector control mode for synchronous motors, you can set the value of this function code to P03.10. Range: 0–65535 Note: Set the value to 0 if motor parameter autotuning is not performed.	0	<input checked="" type="radio"/>

P04—V/F control

Function code	Name	Detailed parameter description	Default value	Modify
P04.00	V/F curve setup of motor 1	<p>This group of function code defines the V/F curve of motor 1 to satisfy different load characteristics needs.</p> <p>0: Straight V/F curve; fit for constant-torque load 1: Multi-point V/F curve 2: Torque down V/F curve (1.3th order) 3: Torque down V/F curve (1.7th order) 4: Torque down V/F curve (2.0nd order)</p> <p>Curve 2–4 are suitable for torque-variable load of fan pump and similar equipment. Users can make adjustment based on load characteristics to achieve optimal energy-saving effect.</p> <p>5: Customized V/F (V/F separation); under this mode, V is separated from f. Users can adjust f through the frequency reference channel set by P00.06 to change the curve characteristic, or adjust V through the voltage reference channel set by P04.27 to change the curve characteristics.</p> <p>Note: The V_b in the figure below corresponds to rated motor voltage, and f_b corresponds to rated motor frequency.</p>	0	⊙
P04.01	Torque boost of motor 1	In order to compensate for low-frequency torque characteristics, users can make some boost compensation to the output voltage. P04.01 is relative to the max. output voltage V_b .	0.0%	○
P04.02	Motor 1 torque boost cut-off	P04.02 defines the percentage of cut-off frequency of manual torque boost to the rated motor frequency f_b . Torque boost can improve the low-frequency torque characteristics of V/F. Users should select torque boost based on the load, eg, larger load requires larger torque boost,	20.0%	○

Function code	Name	Detailed parameter description	Default value	Modify
		<p>however, if the torque boost is too large, the motor will run at over-excitation, which will cause increased output current and motor heat-up, thus degrading the efficiency.</p> <p>When torque boost is set to 0.0%, the VFD is automatic torque boost.</p> <p>Torque boost cut-off threshold: Below this frequency threshold, the torque boost is valid, exceeding this threshold will nullify torque boost.</p> <p>Setting range of P04.01: 0.0%: (automatic) 0.1%–10.0%</p> <p>Setting range of P04.02: 0.0%–50.0%</p>		
P04.03	V/F frequency point 1 of motor 1	When P04.00 =1 (multi-point V/F curve), users can set V/F curve via P04.03–P04.08 .	0.00Hz	<input type="radio"/>
P04.04	V/F voltage point 1 of motor 1	V/F curve is usually set according to the characteristics of motor load.	00.0%	<input type="radio"/>
P04.05	V/F frequency point 2 of motor 1	Note: $V1 < V2 < V3$, $f1 < f2 < f3$. If low-frequency voltage is set too high, motor overheat or burnt-down may occur, and overcurrent stall or overcurrent protection may occur to the VFD.	0.00Hz	<input type="radio"/>
P04.06	V/F voltage point 2 of motor 1		0.0%	<input type="radio"/>
P04.07	V/F frequency point 3 of motor 1		0.00Hz	<input type="radio"/>
P04.08	V/F voltage point 3 of motor 1	<p>Setting range of P04.03: 0.00Hz–P04.05</p> <p>Setting range of P04.04: 0.0%–110.0% (rated voltage of motor 1)</p>	00.0%	<input type="radio"/>

Function code	Name	Detailed parameter description	Default value	Modify
		Setting range of P04.05 : P04.03 – P04.07 Setting range of P04.06 : 0.0%–110.0% (rated voltage of motor 1) Setting range of P04.07 : P04.05 – P02.02 (rated frequency of motor 1) or P04.05 – P02.16 (rated frequency of motor 1) Setting range of P04.08 : 0.0%–110.0% (rated voltage of motor 1)		
P04.09	V/F slip compensation gain of motor 1	This function code is used to compensate for the motor speed changes occurred during load variation in SVPWM control mode, thus improving the rigidity of mechanical characteristics of motor. Rated slip frequency of the motor should be calculated. $\Delta f = fb - n \times p / 60$ of which: fb is rated motor frequency, corresponds to P02.02 ; n is rated motor speed, corresponds to P02.03 ; p is the number of motor pole pairs. 100% corresponds to the rated slip frequency of motor Δf . Setting range: 0.0–200.0%	0.0%	<input type="radio"/>
P04.10	Low-frequency oscillation control factor of motor 1	Under SVPWM control mode, the motor, especially the large-power motor may experience current oscillation during certain frequencies,	10	<input type="radio"/>
P04.11	High-frequency oscillation control factor of motor 1	which may lead to unstable motor operation, or even VFD overcurrent, users can adjust these two parameters properly to eliminate such phenomenon.	10	<input type="radio"/>
P04.12	Oscillation control threshold of motor 1	Setting range of P04.10 : 0–100 Setting range of P04.11 : 0–100 Setting range of P04.12 : 0.00Hz– P00.03 (max. output frequency)	30.00Hz	<input type="radio"/>
P04.13	V/F curve setup of motor 2	0: Straight V/F curve; 1: Multi-point V/F curve 2: Torque-down V/F curve (1.3 th order) 3: Torque-down V/F curve (1.7 th order) 4: Torque-down V/F curve (2.0 th order) 5: Customize V/F (V/F separation)	0	<input checked="" type="radio"/>

Function code	Name	Detailed parameter description	Default value	Modify
P04.14	Torque boost of motor 2	0.0%: (automatic) 0.1%–10.0%	0.0%	○
P04.15	Motor 2 torque boost cut-off	0.0%–50.0% (relative to rated frequency of motor 2)	20.0%	○
P04.16	V/F frequency point 1 of motor 2	0.00Hz– P04.18	0.00Hz	○
P04.17	V/F voltage point 1 of motor 2	0.0%–110.0% (rated voltage of motor 2)	00.0%	○
P04.18	V/F frequency point 2 of motor 2	P04.16 – P04.20	0.00Hz	○
P04.19	V/F voltage point 2 of motor 2	0.0%–110.0% (rated voltage of motor 2)	00.0%	○
P04.20	V/F frequency point 3 of motor 2	P04.18 – P12.02 (rated frequency of asynchronous motor 2) Or P04.18 – P12.16 (rated frequency of synchronous motor 2)	0.00Hz	○
P04.21	V/F voltage point 3 of motor 2	0.0%–110.0% (rated motor voltage)	00.0%	○
P04.22	V/F slip compensation gain of motor 2	0.0–200.0%	0.0%	○
P04.23	Low-frequency oscillation control factor of motor 2	0–100	10	○
P04.24	High-frequency oscillation control factor of motor 2	0–100	10	○
P04.25	Oscillation control threshold of motor 2	0.00Hz– P00.03 (max. output frequency)	30.00Hz	○
P04.26	Energy-saving run	0: No action 1: Automatic energy-saving operation Under light-load state, the motor can adjust the output voltage automatically to achieve energy-saving purpose	0	◎
P04.27	Channel of voltage setup	0: Keypad; output voltage is determined by P04.28 1: AI1	0	○

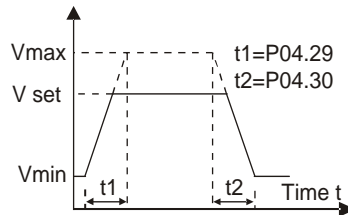
Function code	Name	Detailed parameter description	Default value	Modify
		2: AI2 3: AI3 4: HDIA 5: Multi-step (the set value is determined by P10 group) 6: PID 7: Modbus communication 8: PROFIBUS/CANopen/DeviceNet communication 9: Ethernet communication 10: HDIB 11: EtherCAT/PROFINET communication 12: PLC programmable card 13: Reserved		
P04.28	Set voltage value via keypad	When the channel for voltage setup is set to "keypad", the value of this function code is digital voltage set value. Setting range: 0.0%–100.0%	100.0%	○
P04.29	Voltage acceleration time	Voltage increase time means the time needed from outputting the min. voltage to accelerating to output the max. voltage.	5.0s	○
P04.30	Voltage deceleration time	Voltage decrease time means the time needed from outputting max. voltage to outputting the min. voltage Setting range: 0.0–3600.0s	5.0s	○
P04.31	Max. output voltage	Set the upper/lower limit value of output voltage.	100.0%	◎
P04.32	Min. output voltage	 <p>Setting range of P04.31: P04.32–100.0% (rated motor voltage) Setting range of P04.32: 0.0%–P04.31</p>	0.0%	◎

Function code	Name	Detailed parameter description	Default value	Modify
P04.33	Flux-weakening coefficient of constant-power zone	1.00–1.30	1.00	<input type="radio"/>
P04.34	VF pull-in current 1 of synchronous motor	-100.0%–100.0% (rated motor current)	20.0%	<input type="radio"/>
P04.35	VF pull-in current 2 of synchronous motor	-100.0%–100.0% (rated motor current)	10.0%	<input type="radio"/>
P04.36	VF pull-in current frequency switch-over threshold of synchronous motor	0.00Hz– P00.03 (max. output frequency)	50.00Hz	<input type="radio"/>
P04.37	VF reactive closed-loop proportional coefficient of synchronous motor	0–3000	50	<input type="radio"/>
P04.38	VF reactive closed-loop integral time of synchronous motor	0–3000	30	<input type="radio"/>
P04.39	VF reactive closed-loop output limit of synchronous motor	0–16000	8000	<input type="radio"/>
P04.40	Enable/disable IF mode of asynchronous motor 1	0–1	0	<input checked="" type="radio"/>
P04.41	IF current setting of asynchronous motor 1	0.0–200.0%	120.0%	<input type="radio"/>

Function code	Name	Detailed parameter description	Default value	Modify
P04.42	IF proportional coefficient of asynchronous motor 1	0–5000	650	<input type="radio"/>
P04.43	IF integral coefficient of asynchronous motor 1	0–5000	350	<input type="radio"/>
P04.44	Starting frequency point for switching off IF mode for asynchronous motor 1	0.00–P04.50	10.00Hz	<input type="radio"/>
P04.45	Enable/disable IF mode of asynchronous motor 2	0–1	0	<input checked="" type="radio"/>
P04.46	IF current setting of asynchronous motor 2	0.0–200.0%	120.0%	<input type="radio"/>
P04.47	IF proportional coefficient of asynchronous motor 2	0–5000	650	<input type="radio"/>
P04.48	IF integral coefficient of asynchronous motor 2	0–5000	350	<input type="radio"/>
P04.49	Starting frequency point for switching off IF mode for asynchronous motor 2	0.00–P04.51	10.00Hz	<input type="radio"/>
P04.50	End frequency point for switching off IF	P04.44–P00.03	25.00Hz	<input checked="" type="radio"/>

Function code	Name	Detailed parameter description	Default value	Modify
	mode for asynchronous motor 1			
P04.51	End frequency point for switching off IF mode for asynchronous motor 2	P04.49–P00.03	25.00Hz	●

P05—Input terminals

Function code	Name	Detailed parameter description	Default value	Modify
P05.00	HDI input type	0x00–0x11 Ones: HDIA input type 0: HDIA is high-speed pulse input 1: HDIA is digital input Tens: HDIB input type 0: HDIB is high-speed pulse input 1: HDIB is digital input	0	◎
P05.01	Function of S1 terminal	0: No function 1: Forward running	1	◎
P05.02	Function of S2 terminal	2: Reverse running 3: 3-wire control	4	◎
P05.03	Function of S3 terminal	4: Forward jogging 5: Reverse jogging	7	◎
P05.04	Function of S4 terminal	6: Coast to stop 7: Fault reset	0	◎
P05.05	Function of HDIA terminal	8: Running pause 9: External fault input	0	◎
P05.06	Function of HDIB terminal	10: Frequency increase (UP) 11: Frequency decrease (DOWN) 12: Clear frequency increase/decrease setting 13: Switch-over between setup A and setup B 14: Switch-over between combination setup and setup A 15: Switch-over between combination setup and	0	◎

Function code	Name	Detailed parameter description	Default value	Modify
		setup B 16: Multi-step speed terminal 1 17: Multi-step speed terminal 2 18: Multi-step speed terminal 3 19: Multi-step speed terminal 4 20: Multi-step speed pause 21: Acceleration/deceleration time selection 1 22: Acceleration/deceleration time selection 2 23: Simple PLC stop reset 24: Simple PLC pause 25: PID control pause 26: Wobbling frequency pause 27: Wobbling frequency reset 28: Counter reset 29: Switch-over between speed control and torque control 30: Acceleration/deceleration disabled 31: Counter trigger 32: Reserved 33: Clear frequency increase/decrease setting temporarily 34: DC brake 35: Switch-over between motor 1 and motor 2 36: Command switches to keypad 37: Command switches to terminal 38: Command switches to communication 39: Pre-exciting command 40: Zero out power consumption quantity 41: Maintain power consumption quantity 42: Source of upper torque limit switches to keypad 43: Position reference point input (only S6, S7 and S8 are valid) 44: Spindle orientation disabled 45: Spindle zeroing/local positioning zeroing 46: Spindle zero position selection 1 47: Spindle zero position selection 2 48: Spindle scale division selection 1 49: Spindle scale division selection 2		

Function code	Name	Detailed parameter description	Default value	Modify
		50: Spindle scale division selection 3 51: Position control and speed control switch-over terminal 52: Pulse input disabled 53: Clear position deviation cleared 54: Switch over position proportional gain 55: Enable cyclic positioning of digital position positioning 56: Emergency stop 57: Motor over-temperature fault input 58: Enable rigid tapping 59: Switches to V/F control 60: Switches to FVC control 61: PID polarity switch-over 62: Reserved 63: Enable servo 64: Limit of forward run 65: Limit of reverse run 66: Zero out encoder counting 67: Pulse increase 68: Enable pulse superimposition 69: Pulse decrease 70: Electronic gear selection 71–79: Reserved		
P05.07	Reserved variables	0–65535	0	●
P05.08	Polarity of input terminal	This function code is used to set the polarity of input terminals. When the bit is set to 0, input terminal polarity is positive; When the bit is set to 1, input terminal polarity is negative; 0x000–0x3F	0x000	○
P05.09	Digital filter time	Set S1–S4, filter time of HDI terminal sampling. In cases where interference is strong, increase the value of this parameter to avoid mal-operation. 0.000–1.000s	0.010s	○

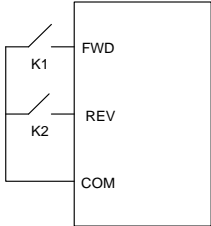
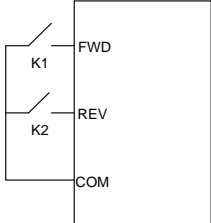
Function code	Name	Detailed parameter description	Default value	Modify																														
P05.10	Virtual terminal setting	0x000–0x3F (0: disable, 1: enable) BIT0: S1 virtual terminal BIT1: S2 virtual terminal BIT2: S3 virtual terminal BIT3: S4 virtual terminal BIT4: HDIA virtual terminal BIT5: HDIB virtual terminal	0x00	⊙																														
P05.11	2/3 wire control mode	<p>This function code is used to set the 2/3 wire control mode.</p> <p>0: 2-wire control 1; integrate enabling function with direction. This mode is the most popular dual-line mode. Direction of motor rotation is determined by the defined FWD/REV terminal command.</p>  <table border="1" data-bbox="632 651 815 877"> <thead> <tr> <th>FWD</th> <th>REV</th> <th>Running command</th> </tr> </thead> <tbody> <tr> <td>OFF</td> <td>OFF</td> <td>Stop</td> </tr> <tr> <td>ON</td> <td>OFF</td> <td>Forward running</td> </tr> <tr> <td>OFF</td> <td>ON</td> <td>Reverse running</td> </tr> <tr> <td>ON</td> <td>ON</td> <td>Hold</td> </tr> </tbody> </table> <p>1: 2-wire control 2; separate enabling function with direction. In this mode, the defined FWD is enabling terminal, and the direction is determined by the state of REV.</p>  <table border="1" data-bbox="632 1013 815 1236"> <thead> <tr> <th>FWD</th> <th>REV</th> <th>Running command</th> </tr> </thead> <tbody> <tr> <td>OFF</td> <td>OFF</td> <td>Stop</td> </tr> <tr> <td>ON</td> <td>OFF</td> <td>Forward running</td> </tr> <tr> <td>OFF</td> <td>ON</td> <td>Stop</td> </tr> <tr> <td>ON</td> <td>ON</td> <td>Reverse running</td> </tr> </tbody> </table> <p>2: 3-wire control 1; This mode defines Sin as enabling terminal, and the running command is generated by FWD, the direction is controlled by REV. During running, the Sin terminal should be closed, and terminal FWD generates a rising edge signal, then the VFD starts to run in the direction set</p>	FWD	REV	Running command	OFF	OFF	Stop	ON	OFF	Forward running	OFF	ON	Reverse running	ON	ON	Hold	FWD	REV	Running command	OFF	OFF	Stop	ON	OFF	Forward running	OFF	ON	Stop	ON	ON	Reverse running	0	⊙
FWD	REV	Running command																																
OFF	OFF	Stop																																
ON	OFF	Forward running																																
OFF	ON	Reverse running																																
ON	ON	Hold																																
FWD	REV	Running command																																
OFF	OFF	Stop																																
ON	OFF	Forward running																																
OFF	ON	Stop																																
ON	ON	Reverse running																																

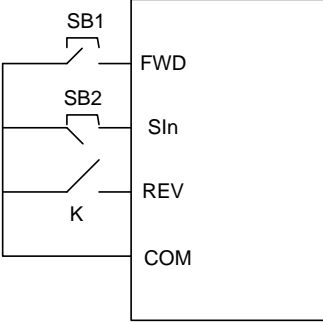
Function code	Name	Detailed parameter description	Default value	Modify																					
		<p>by the state of terminal REV; the VFD should be stopped by disconnecting terminal Sin.</p>  <p>The direction control during running is shown below.</p> <table border="1" data-bbox="378 663 850 983"> <thead> <tr> <th>Sin</th> <th>REV</th> <th>Previous running direction</th> <th>Current running direction</th> </tr> </thead> <tbody> <tr> <td rowspan="2">ON</td> <td rowspan="2">OFF→ON</td> <td>Forward</td> <td>Reverse</td> </tr> <tr> <td>Reverse</td> <td>Forward</td> </tr> <tr> <td rowspan="2">ON</td> <td rowspan="2">ON→OFF</td> <td>Reverse</td> <td>Forward</td> </tr> <tr> <td>Forward</td> <td>Reverse</td> </tr> <tr> <td rowspan="2">ON→OFF</td> <td>ON</td> <td colspan="2" rowspan="2">Decelerate to stop</td> </tr> <tr> <td>OFF</td> </tr> </tbody> </table> <p>SIn: 3-wire control, FWD: Forward running, REV: Reverse running 3: 3-wire control 2; This mode defines Sin as enabling terminal. The running command is generated by FWD or REV, and they control the running direction. During running, the terminal Sin should be closed, and terminal FWD or REV generates a rising edge signal to control the running and direction of VFD; the VFD should be stopped by disconnecting terminal Sin.</p>	Sin	REV	Previous running direction	Current running direction	ON	OFF→ON	Forward	Reverse	Reverse	Forward	ON	ON→OFF	Reverse	Forward	Forward	Reverse	ON→OFF	ON	Decelerate to stop		OFF		
Sin	REV	Previous running direction	Current running direction																						
ON	OFF→ON	Forward	Reverse																						
		Reverse	Forward																						
ON	ON→OFF	Reverse	Forward																						
		Forward	Reverse																						
ON→OFF	ON	Decelerate to stop																							
	OFF																								

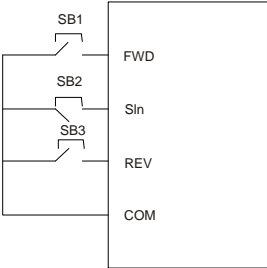
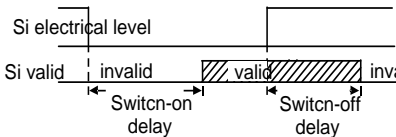
Function code	Name	Detailed parameter description	Default value	Modify																					
		 <table border="1" data-bbox="384 523 844 826"> <thead> <tr> <th>SIn</th> <th>FWD</th> <th>REV</th> <th>Running direction</th> </tr> </thead> <tbody> <tr> <td rowspan="2">ON</td> <td>OFF→ON</td> <td>ON</td> <td>Forward</td> </tr> <tr> <td></td> <td>OFF</td> <td>Forward</td> </tr> <tr> <td rowspan="2">ON</td> <td>ON</td> <td rowspan="2">OFF→ON</td> <td>Reverse</td> </tr> <tr> <td>OFF</td> <td>Reverse</td> </tr> <tr> <td>ON→OFF</td> <td></td> <td></td> <td>Decelerate to stop</td> </tr> </tbody> </table> <p>SIn: 3-wire control, FWD: Forward running, REV: Reverse running</p> <p>Note: For dual-line running mode, when FWD/REV terminal is valid, if the VFD stops due to stop command given by other sources, it will not run again after the stop command disappears even if the control terminals FWD/REV are still valid. To make the VFD run again, users need to trigger FWD/REV again, eg, PLC single-cycle stop, fixed-length stop, and valid STOP/RST stop during terminal control. (see P07.04).</p>	SIn	FWD	REV	Running direction	ON	OFF→ON	ON	Forward		OFF	Forward	ON	ON	OFF→ON	Reverse	OFF	Reverse	ON→OFF			Decelerate to stop		
SIn	FWD	REV	Running direction																						
ON	OFF→ON	ON	Forward																						
		OFF	Forward																						
ON	ON	OFF→ON	Reverse																						
	OFF		Reverse																						
ON→OFF			Decelerate to stop																						
P05.12	S1 terminal switch-on delay	These function codes define corresponding delay of the programmable input terminals during level variation from switch-on to switch-off. 	0.000s	○																					
P05.13	S1 terminal switch-off delay		0.000s	○																					
P05.14	S2 terminal switch-on delay		0.000s	○																					
P05.15	S2 terminal		0.000s	○																					

Function code	Name	Detailed parameter description	Default value	Modify
	switch-off delay	Setting range: 0.000–50.000s.		
P05.16	S3 terminal switch-on delay	Note: After a virtual terminal is enabled, the state of the terminal can only be changed in communication mode. The communication address is 0x200A.	0.000s	<input type="radio"/>
P05.17	S3 terminal switch-off delay		0.000s	<input type="radio"/>
P05.18	S4 terminal switch-on delay		0.000s	<input type="radio"/>
P05.19	S4 terminal switch-off delay		0.000s	<input type="radio"/>
P05.20	HDIA terminal switch-on delay		0.000s	<input type="radio"/>
P05.21	HDIA terminal switch-off delay		0.000s	<input type="radio"/>
P05.22	HDIB terminal switch-on delay		0.000s	<input type="radio"/>
P05.23	HDIB terminal switch-off delay		0.000s	<input type="radio"/>
P05.24	Lower limit value of AI1		These function codes define the relation between analog input voltage and corresponding set value of analog input. When the analog input voltage exceeds the range of max./min. input, the max. input or min. input will be adopted during calculation. When analog input is current input, 0–20mA current corresponds to 0–10V voltage. In different applications, 100% of analog setting corresponds to different nominal values. The figure below illustrates several settings.	0.00V
P05.25	Corresponding setting of lower limit of AI1	0.0%		<input type="radio"/>
P05.26	Upper limit value of AI1	10.00V		<input type="radio"/>
P05.27	Corresponding setting of upper limit of AI1	100.0%		<input type="radio"/>
P05.28	Input filter time of AI1	0.030s		<input type="radio"/>
P05.29	Lower limit value of AI2	-10.00V		<input type="radio"/>
P05.30	Corresponding setting of lower limit of AI2	-100.0%		<input type="radio"/>
P05.31	Intermediate value 1 of AI2	0.00V		<input type="radio"/>

Function code	Name	Detailed parameter description	Default value	Modify
P05.32	Corresponding setting of intermediate value 1 of AI2		0.0%	<input type="radio"/>
P05.33	Intermediate value 2 of AI2		0.00V	<input type="radio"/>
P05.34	Corresponding setting of intermediate value 2 of AI2		0.0%	<input type="radio"/>
P05.35	Upper limit value of AI2		10.00V	<input type="radio"/>
P05.36	Corresponding setting of upper limit of AI2		100.0%	<input type="radio"/>
P05.37	Input filter time of AI2	<p>Note: AI1 can support 0–10V/0–20mA input, when AI1 selects 0–20mA input; the corresponding voltage of 20mA is 10V; AI2 supports -10V+10V input.</p> <p>Setting range of P05.24: 0.00V–P05.26</p> <p>Setting range of P05.25: -300.0%–300.0%</p> <p>Setting range of P05.26: P05.24–10.00V</p> <p>Setting range of P05.27: -300.0%–300.0%</p> <p>Setting range of P05.28: 0.000s–10.000s</p> <p>Setting range of P05.29: -10.00V–P05.31</p> <p>Setting range of P05.30: -300.0%–300.0%</p> <p>Setting range of P05.31: P05.29–P05.33</p> <p>Setting range of P05.32: -300.0%–300.0%</p> <p>Setting range of P05.33: P05.31–P05.35</p> <p>Setting range of P05.34: -300.0%–300.0%</p> <p>Setting range of P05.35: P05.33–10.00V</p> <p>Setting range of P05.36: -300.0%–300.0%</p> <p>Setting range of P05.37: 0.000s–10.000s</p>	0.030s	<input type="radio"/>
P05.38	HDIA high-speed pulse input function	0: Set input via frequency 1: Reserved 2: Input via encoder, used in combination with HDIB	0	<input checked="" type="radio"/>
P05.39	Lower limit frequency of HDIA	0.000 kHz– P05.41	0.000 kHz	<input type="radio"/>

Function code	Name	Detailed parameter description	Default value	Modify
P05.40	Corresponding setting of lower limit frequency of HDIA	-300.0%~300.0%	0.0%	<input type="radio"/>
P05.41	Upper limit frequency of HDIA	P05.39 ~50.000kHz	50.000 kHz	<input type="radio"/>
P05.42	Corresponding setting of upper limit frequency of HDIA	-300.0%~300.0%	100.0%	<input type="radio"/>
P05.43	HDIA frequency input filter time	0.000s~10.000s	0.030s	<input type="radio"/>
P05.44	HDIB high-speed pulse input function selection	0: Set input via frequency 1: Reserved 2: Encoder input, it should be used in combination with HDIA	0	<input checked="" type="radio"/>
P05.45	Lower limit frequency of HDIB	0.000 kHz~ P05.47	0.000 kHz	<input type="radio"/>
P05.46	Corresponding setting of lower limit frequency of HDIB	-300.0%~300.0%	0.0%	<input type="radio"/>
P05.47	Upper limit frequency of HDIB	P05.45 ~50.000kHz	50.000 kHz	<input type="radio"/>
P05.48	Corresponding setting of upper limit frequency of HDIB	-300.0%~300.0%	100.0%	<input type="radio"/>
P05.49	HDIB frequency input filter time	0.000s~10.000s	0.030s	<input type="radio"/>
P05.50	AI1 input signal type	0~1 0: Voltage type 1: Current type Note: You can set the AI1 input signal type through the corresponding function code.	0	<input checked="" type="radio"/>

Function code	Name	Detailed parameter description	Default value	Modify
P05.51– P05.52	Reserved variables	0–65535	0	●

P06—Output terminals

Function code	Name	Detailed parameter description	Default value	Modify
P06.00	HDO output type	0: Open collector high-speed pulse output: Max. frequency of the pulse is 50.00kHz. For details about the related functions, see P06.27–P06.31 . 1: Open collector output: For details about the related functions, see P06.02 .	0	◎
P06.01	Y output selection	0: Invalid 1: In running	0	○
P06.02	HDO output selection	2: In forward running 3: In reverse running	0	○
P06.03	Relay RO1 output selection	4: In jogging 5: VFD fault	1	○
P06.04	Relay RO2 output selection	6: Frequency level detection FDT1 7: Frequency level detection FDT2 8: Frequency reached 9: Running in zero speed 10: Reach upper limit frequency 11: Reach lower limit frequency 12: Ready to run 13: In pre-exciting 14: Overload pre-alarm 15: Underload pre-alarm 16: Simple PLC stage completed 17: Simple PLC cycle completed 18: Reach set counting value 19: Reach designated counting value 20: External fault is valid 21: Reserved 22: Reach running time 23: Virtual terminal output of Modbus communication 24: Virtual terminal output of POROFIBUS/ CANopen communication	5	○

Function code	Name	Detailed parameter description	Default value	Modify								
		25: Virtual terminal output of Ethernet communication 26: DC bus voltage established 27: z pulse output 28: During pulse superposition 29: STO act 30: Positioning completed 31: Spindle zeroing completed 32: Spindle scale-division completed 33: In speed limit 34–35: Reserved 36: Speed/position control switch-over completed 37: Any frequency reached 38–40: Reserved 41: C_Y1 from PLC (set P27.00 to 1) 42: C_Y2 from PLC (set P27.00 to 1) 43: C_HDO from PLC (set P27.00 to 1) 44: C_RO1 from PLC (set P27.00 to 1) 45: C_RO2 from PLC (set P27.00 to 1) 46: C_RO3 from PLC (set P27.00 to 1) 47: C_RO4 from PLC (set P27.00 to 1) 48–63: Reserved 29: STO action 48–63: Reserved										
P06.05	Output terminal polarity selection	This function code is used to set the polarity of output terminals. When the bit is set to 0, input terminal polarity is positive; When the bit is set to 1 input terminal polarity is negative. <table border="1" style="margin-left: auto; margin-right: auto;"> <tr> <td style="text-align: center;">BIT3</td> <td style="text-align: center;">BIT2</td> <td style="text-align: center;">BIT1</td> <td style="text-align: center;">BIT0</td> </tr> <tr> <td style="text-align: center;">RO2</td> <td style="text-align: center;">RO1</td> <td style="text-align: center;">HDO</td> <td style="text-align: center;">Y</td> </tr> </table> Setting range: 0x0–0Xf	BIT3	BIT2	BIT1	BIT0	RO2	RO1	HDO	Y	00	○
BIT3	BIT2	BIT1	BIT0									
RO2	RO1	HDO	Y									
P06.06	Y switch-on delay		0.000s	○								
P06.07	Y switch-off delay	This function code defines the corresponding delay of the level variation from switch-on to switch-off.	0.000s	○								
P06.08	HDO switch-on delay		0.000s	○								

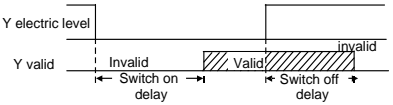
Function code	Name	Detailed parameter description	Default value	Modify
P06.09	HDO switch-off delay	 <p>Setting range: 0.000–50.000s</p> <p>Note: P06.08 and P06.09 are valid only when P06.00=1.</p>	0.000s	<input type="radio"/>
P06.10	Relay RO1 switch-on delay		0.000s	<input type="radio"/>
P06.11	Relay RO1 switch-off delay		0.000s	<input type="radio"/>
P06.12	Relay RO2 switch-on delay		0.000s	<input type="radio"/>
P06.13	Relay RO2 switch-off delay		0.000s	<input type="radio"/>
P06.14	AO1 output selection	0: Running frequency (0–Max. output frequency)	0	<input type="radio"/>
P06.15	Reserved	1: Set frequency (0–Max. output frequency)	0	<input type="radio"/>
P06.16	HDO high-speed pulse output	2: Ramp reference frequency (0–Max. output frequency)	0	<input type="radio"/>
		3: Rotational speed (0–Speed corresponding to max. output frequency)		
		4: Output current (0–Twice the VFD rated current)		
		5: Output current (0–Twice the motor rated current)		
		6: Output voltage (0–1.5 times the VFD rated voltage)		
		7: Output power (0–Twice the motor rated power)		
		8: Set torque (0–Twice the motor rated current)		
		9: Output torque (Absolute value, 0–+/- Twice the motor rated torque)		
		10: AI1 input (0–10V/0–20mA)		
		11: AI2 input (0–10V)		
		12: AI3 input (0–10V/0–20mA)		
		13: HDIA input(0.00–50.00kHz)		
		14: Value 1 set through Modbus (0–1000)		
		15: Value 2 set through Modbus (0–1000)		
		16: Value 1 set through PROFIBUS/CANopen/DeviceNet (0–1000)		
17: Value 2 set through PROFIBUS/CANopen/DeviceNet (0–1000)				
18: Value 1 set through Ethernet 1 (0–1000)				
19: Value 2 set through Ethernet 2 (0–1000)				
		20: HDIB input (0.00–50.00kHz)		

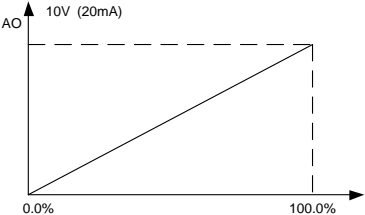
Function code	Name	Detailed parameter description	Default value	Modify
		21: Value 1 set through EtherCAT/Profinet/EtherNet/IP (0–1000) 22: Torque current (bipolar, 0–Triple the motor rated current) 23: Exciting current (bipolar, 0–Triple the motor rated current) 24: Set frequency (bipolar, 0–Max. output frequency) 25: Ramp reference frequency (bipolar, 0–Max. output frequency) 26: Rotational speed (bipolar, 0–Speed corresponding to max. output frequency) 27: Value 2 set through EtherCAT/Profinet/EtherNet/IP (0–1000) 28: C_AO1 (Set P27.00 to 1. 0–1000) 29: C_AO2 (Set P27.00 to 1. 0–1000) 30: Rotational speed (0–Twice the motor rated synchronous speed) 31: Output torque (Actual value, 0–Twice the motor rated torque) 32–47: Reserved EtherCAT/EtherCAT		
P06.17	Lower limit of AO1 output	Above function codes define the relation between output value and analog output. When the output value exceeds the set max./min. output range, the upper/low limit of output will be adopted during calculation. When analog output is current output, 1mA corresponds to 0.5V voltage. In different applications, 100% of output value corresponds to different analog outputs.	0.0%	<input type="radio"/>
P06.18	Corresponding AO1 output of lower limit		0.00V	<input type="radio"/>
P06.19	Upper limit of AO1 output		100.0%	<input type="radio"/>
P06.20	Corresponding AO1 output of upper limit		10.00V	<input type="radio"/>
P06.21	AO1 output filter time			0.000s
		Setting range of P06.17 : -300.0%– P06.19		

Function code	Name	Detailed parameter description	Default value	Modify
		Setting range of P06.18 : 0.00V–10.00V Setting range of P06.19 : P06.17 –300.0% Setting range of P06.20 : 0.00V–10.00V Setting range of P06.21 : 0.000s–10.000s		
P06.22– P06.26	Reserved variables	0–65535	0	●
P06.27	Lower limit of HDO output	-300.0%– P06.29	0.00%	○
P06.28	Corresponding HDO output of lower limit	0.00–50.00kHz	0.00kHz z	○
P06.29	Upper limit of HDO output	P06.27 –300.0%	100.0%	○
P06.30	Corresponding HDO output of upper limit	0.00–50.00kHz	50.00 kHz	○
P06.31	HDO output filter time	0.000s–10.000s	0.000s	○
P06.32	Reserved variable	0–65535	0	●
P06.33	Frequency reach detection value	0–P00.03	1.00Hz	○
P06.34	Frequency reach detection time	0–3600.0s	0.5s	○

P07—HMI

Function code	Name	Detailed parameter description	Default value	Modify
P07.00	User password	0–65535 Set it to any non-zero value to enable password protection. 00000: Clear previous user password and disable password protection. After user password becomes valid, if wrong password is inputted, users will be denied entry. It is necessary to keep the user password in mind. Password protection will be effective one minute	0	○

Function code	Name	Detailed parameter description	Default value	Modify
		after exiting function code edit state, and it will display "0.0.0.0.0" if users press PRG/ESC key to enter function code edit state again, users need to input the correct password. Note: Restoring to default values will clear user password, use this function with caution.		
P07.01	Reserved		/	/
P07.02	Function of keys	Range: 0x00–0x27 Ones: Function selection of QUICK/JOG key 0: No function 1: Jogging 2: Reserved 3: Forward/reverse rotation switch-over 4: Clear UP/DOWN setting 5: Coast to stop 6: Switch over the running command reference mode in sequence 7: Reserved Tens: Reserved	0x01	⊙
P07.03	Running command channel switch-over sequence of QUICK key	When P07.02 =6, set the switch-over sequence of running command channel. 0: keypad control→terminal control→communication control 1: keypad control←→terminal control 2: keypad control←→communication control 3: terminal control←→communication control	0	○
P07.04	Stop function selection of STOP/RST key	Validness selection of stop function of STOP/RST . For fault reset, STOP/RST is valid under any situation. 0: valid only for panel control only 1: valid for both panel and terminal control 2: valid for both panel and communication control 3: valid for all control modes	0	○
P07.05–P07.07	Reserved		/	/
P07.08	Frequency display coefficient	0.01–10.00 Display frequency=running frequency× P07.08	1.00	○

Function code	Name	Detailed parameter description	Default value	Modify
P07.09	Speed display coefficient	0.1–999.9% Mechanical speed=120×display running frequency× P07.09 /number of motor pole pairs	100.0%	○
P07.10	Linear speed display coefficient	0.1–999.9% Linear speed=mechanical speed× P07.10	1.0%	○
P07.11	Temperature of rectifier bridge module	-20.0–120.0°C	/	●
P07.12	Temperature of inverter module	-20.0–120.0°C	/	●
P07.13	Software version of control board	1.00–655.35	/	●
P07.14	Accumulated running time	0–65535h	/	●
P07.15	High bit of VFD power consumption	Display the power consumption of the VFD. VFD power consumption= P07.15 ×1000+ P07.16	/	●
P07.16	Low bit of VFD power consumption	Setting range of P07.15 : 0–65535 kWh (×1000) Setting range of P07.16 : 0.0–999.9 kWh	/	●
P07.17	Reserved		/	/
P07.18	Rated power of VFD	0.4–3000.0kW	/	●
P07.19	Rated voltage of VFD	50–1200V	/	●
P07.20	Rated current of VFD	0.1–6000.0A	/	●
P07.21	Factory barcode 1	0x0000–0xFFFF	/	●
P07.22	Factory barcode 2	0x0000–0xFFFF	/	●
P07.23	Factory barcode 3	0x0000–0xFFFF	/	●
P07.24	Factory barcode 4	0x0000–0xFFFF	/	●
P07.25	Factory barcode 5	0x0000–0xFFFF	/	●
P07.26	Factory barcode 6	0x0000–0xFFFF	/	●
P07.27	Type of present fault	0: No fault 1: Inverter unit U phase protection (OUt1)	/	●

Function code	Name	Detailed parameter description	Default value	Modify
P07.28	Type of the last fault	2: Inverter unit V phase protection (OUt2) 3: Inverter unit W phase protection (OUt3)	/	●
P07.29	Type of the last but one fault	4: Overcurrent during acceleration (OC1) 5: Overcurrent during deceleration (OC2)	/	●
P07.30	Type of the last but two fault	6: Overcurrent during constant speed (OC3) 7: Overvoltage during acceleration (OV1)	/	●
P07.31	Type of the last but three fault	8: Overvoltage during deceleration (OV2) 9: Overvoltage during constant speed (OV3)	/	●
P07.32	Type of the last but four fault	10: Bus undervoltage fault (UV) 11: Motor overload (OL1) 12: VFD overload (OL2) 13: Phase loss on input side (SPI) 14: Phase loss on output side (SPO) 15: Rectifier module overheat (OH1) 16: Inverter module overheat (OH2) 17: External fault (EF) 18: 485 communication fault (CE) 19: Current detection fault (ItE) 20: Motor autotuning fault (tE) 21: EEPROM operation fault (EEP) 22: PID feedback offline fault (PIDE) 23: Brake unit fault (bCE) 24: Running time reached (END) 25: Electronic overload (OL3) 26: Keypad communication error (PCE) 27: Parameter upload error (UPE) 28: Parameter download error (DNE) 29: PROFIBUS communication fault (E-DP) 30: Ethernet communication fault (E-NET) 31: CANopen communication fault (E-CAN) 32: To-ground short-circuit fault 1 (ETH1) 33: To-ground short-circuit fault 2 (ETH2) 34: Speed deviation fault (dEu) 35: Mal-adjustment fault (STo) 36: Underload fault (LL) 37: Encoder offline fault (ENC1O) 38: Encoder reversal fault (ENC1D) 39: Encoder Z pulse offline fault (ENC1Z)	/	●

Function code	Name	Detailed parameter description	Default value	Modify
		40: Safe torque off (STO) 41: Channel H1 safety circuit exception (STL1) 42: Channel H2 safety circuit exception (STL2) 43: Channel H1 and H2 exception (STL3) 44: Safety code FLASH CRC fault (CrCE) 45: PLC card customized fault 1 (P-E1) 46: PLC card customized fault 2 (P-E2) 47: PLC card customized fault 3 (P-E3) 48: PLC card customized fault 4 (P-E4) 49: PLC card customized fault 5 (P-E5) 50: PLC card customized fault 6 (P-E6) 51: PLC card customized fault 7 (P-E7) 52: PLC card customized fault 8 (P-E8) 53: PLC card customized fault 9 (P-E9) 54: PLC card customized fault 10 (P-E10) 55: Repetitive extension card type fault (E-Err) 56: Encoder UVW loss fault (ENCUV) 57: PROFIBUS communication fault (E-PN) 58: CANopen communication fault (ESCAN) 59: Motor over-temperature fault (OT) 60: Card slot 1 card identification failure (F1-Er) 61: Card slot 2 card identification failure (F2-Er) 62: Card slot 3 card identification failure (F3-Er) 63: Card slot 1 card communication timeout fault (C1-Er) 64: Card slot 2 card communication timeout fault (C2-Er) 65: Card slot 3 card communication timeout fault (C3-Er) 66: EtherCAT communication fault (E-CAT) 67: Bacnet communication fault (E-BAC) 68: DeviceNet communication fault (E-DEV) 69: Master-slave synchronous CAN slave fault (S-Err)		
P07.33	Running frequency of present fault	0.00Hz~P00.03	0.00Hz	●

Function code	Name	Detailed parameter description	Default value	Modify
P07.34	Ramp reference frequency of present fault	0.00Hz~P00.03	0.00Hz	●
P07.35	Output voltage of present fault	0~1200V	0V	●
P07.36	Output current of present fault	0.0~6300.0A	0.0A	●
P07.37	Bus voltage of present fault	0.0~2000.0V	0.0V	●
P07.38	Max. temperature of present fault	-20.0~120.0°C	0.0°C	●
P07.39	Input terminal state of present fault	0x0000~0xFFFF	0	●
P07.40	Output terminal state of present fault	0x0000~0xFFFF	0	●
P07.41	Running frequency of the last fault	0.00Hz~P00.03	0.00Hz	●
P07.42	Ramp reference frequency of the last fault	0.00Hz~P00.03	0.00Hz	●
P07.43	Output voltage of the last fault	0~1200V	0V	●
P07.44	Output current of the last fault	0.0~6300.0A	0.0A	●
P07.45	Bus voltage of the last fault	0.0~2000.0V	0.0V	●
P07.46	Max. temperature of the last fault	-20.0~120.0°C	0.0°C	●
P07.47	Input terminal state of the last fault	0x0000~0xFFFF	0	●
P07.48	Output terminal state of the last fault	0x0000~0xFFFF	0	●

Function code	Name	Detailed parameter description	Default value	Modify
P07.49	Running frequency of the 2nd-last fault	0.00Hz–P00.03	0.00Hz	●
P07.50	Ramp reference frequency of the 2nd-last fault	0.00Hz–P00.03	0.00Hz	●
P07.51	Output voltage of the 2nd-last fault	0–1200V	0V	●
P07.52	Output current of the 2nd-last fault	0.0–6300.0A	0.0A	●
P07.53	Bus voltage of the 2nd-last fault	0.0–2000.0V	0.0V	●
P07.54	Max. temperature of the 2nd-last fault	-20.0–120.0°C	0.0°C	●
P07.55	Input terminal state of the 2nd-last fault	0x0000–0xFFFF	0	●
P07.56	Output terminal state of the 2nd-last fault	0x0000–0xFFFF	0	●

P08—Enhanced functions

Function code	Name	Detailed parameter description	Default value	Modify
P08.00	Acceleration time 2	See P00.11 and P00.12 for detailed definitions. The Goodrive350 IP54 high protection high-ingress protection Goodrive350 series VFD defines four groups of acceleration/deceleration time, which can be selected by multi-function digital input terminal (P05 group). The acceleration/deceleration time of the VFD is the first group by default. Setting range: 0.0–3600.0s	Depends on model	○
P08.01	Deceleration time 2		Depends on model	○
P08.02	Acceleration time 3		Depends on model	○
P08.03	Deceleration time 3		Depends on model	○
P08.04	Acceleration time 4		Depends on model	○
P08.05	Deceleration time 4		Depends on model	○

Function code	Name	Detailed parameter description	Default value	Modify
P08.06	Running frequency of jogging	This function code is used to define the reference frequency of the VFD during jogging. Setting range: 0.00Hz– P00.03 (max. output frequency)	5.00Hz	<input type="radio"/>
P08.07	Acceleration time of jogging	Jogging acceleration time is the time needed for the VFD to accelerate from 0Hz to max. output frequency (P00.03).	Depends on model	<input type="radio"/>
P08.08	Deceleration time of jogging	Jogging deceleration time is the time needed from decelerating from the max. output frequency (P00.03) to 0Hz. Setting range: 0.0–3600.0s		<input type="radio"/>
P08.09	Jump frequency 1	When the set frequency is within the range of jump frequency, the VFD will run at the boundary of jump frequency. The VFD can avoid mechanical resonance point by setting the jump frequency, and three jump frequency points can be set. If the jump frequency points are set to 0, this function will be invalid.	0.00Hz	<input type="radio"/>
P08.10	Jump frequency amplitude 1		0.00Hz	<input type="radio"/>
P08.11	Jump frequency 2		0.00Hz	<input type="radio"/>
P08.12	Jump frequency amplitude 2		0.00Hz	<input type="radio"/>
P08.13	Jump frequency 3		0.00Hz	<input type="radio"/>
P08.14	Jump frequency amplitude 3		0.00Hz	<input type="radio"/>
		Setting range: 0.00Hz– P00.03 (max. output frequency)		
P08.15	Amplitude of wobbling frequency	0.0–100.0% (relative to set frequency)	0.0%	<input type="radio"/>
P08.16	Amplitude of jump frequency	0.0–50.0% (relative to amplitude of wobbling frequency)	0.0%	<input type="radio"/>
P08.17	Rise time of wobbling frequency	0.1–3600.0s	5.0s	<input type="radio"/>
P08.18	Descend time of wobbling frequency	0.1–3600.0s	5.0s	<input type="radio"/>

Function code	Name	Detailed parameter description	Default value	Modify
P08.19	Switching frequency of acceleration/deceleration time	0.00– P00.03 (max. output frequency) 0.00Hz: no switch-over Switch to acceleration/deceleration time 2 if the running frequency is larger than P08.19	0.00Hz	<input type="radio"/>
P08.20	Frequency threshold of the start of droop control	0.00–50.00Hz	2.00Hz	<input type="radio"/>
P08.21	Reference frequency of acceleration/deceleration time	0: Max. output frequency 1: Set frequency 2: 100Hz Note: Valid for straight acceleration/deceleration only.	0	<input checked="" type="radio"/>
P08.22	Reserved variables	0–65535	0	<input type="radio"/>
P08.23	Number of decimal points of frequency	0: Two decimal points 1: One decimal point	0	<input type="radio"/>
P08.24	Number of decimal points of linear speed	0: No decimal point 1: One 2: Two 3: Three	0	<input type="radio"/>
P08.25	Set count value	P08.26 –65535	0	<input type="radio"/>
P08.26	Designated count value	0– P08.25	0	<input type="radio"/>
P08.27	Set running time	0–65535min	0min	<input type="radio"/>
P08.28	Automatic fault reset times	Automatic fault reset times: When the VFD selects automatic fault reset, it is used to set the times of automatic reset, if the continuous reset times exceeds the value set by P08.29, the VFD will report fault and stop to wait for repair.	0	<input type="radio"/>
P08.29	Automatic fault reset time interval	Interval of automatic fault reset: select the interval time from when fault occurred to automatic fault reset actions. After VFD starts, if no fault occurred during 60s, the fault reset times will be zeroed out. Setting range of P08.28 : 0–10 Setting range of P08.29 : 0.1–3600.0s	1.0s	<input type="radio"/>

Function code	Name	Detailed parameter description	Default value	Modify
P08.30	Reduction ratio of droop control	This function code sets the variation rate of the VFD output frequency based on the load; it is mainly used in balancing the power when multiple motors drive the same load. Setting range: 0.00–50.00Hz	0.00Hz	<input type="radio"/>
P08.31	Switch-over between motor 1 and motor 2	0x00–0x14 Ones: Switch-over channel 0: Switch over by terminal 1: Switch over by Modbus communication 2: Switch over by PROFIBUS/CANopen/DeviceNet 3: Switch over by Ethernet communication 4: Switch over by EtherCAT/PROFINET communication Tens: Motor switch over during running 0: Disable switch over during running 1: Enable switch over during running	0x00	<input checked="" type="radio"/>
P08.32	FDT1 level detection value	When the output frequency exceeds the corresponding frequency of FDT level, multi-function digital outputs "frequency level detection FDT" signal, this signal will be valid until the output frequency lowers to below the corresponding frequency (FDT level-FDT lag detection value), the waveform is shown in the figure below.	50.00Hz	<input type="radio"/>
P08.33	FDT1 lag detection value		5.0%	<input type="radio"/>
P08.34	FDT2 level detection value		50.00Hz	<input type="radio"/>
P08.35	FDT2 lag detection value	<p>Setting range of P08.32: 0.00Hz–P00.03 (max. output frequency) Setting range of P08.33: 0.0–100.0% (FDT1 level) Setting range of P08.34: 0.00Hz–P00.03 (max. output frequency) Setting range of P08.35: 0.0–100.0% (FDT2 level)</p>	5.0%	<input type="radio"/>

Function code	Name	Detailed parameter description	Default value	Modify
P08.36	Detection value for frequency arrival	<p>When the output frequency is within the positive /negative detection range of the set frequency, the multi-function digital output terminal outputs "frequency arrival" signal as shown below.</p> <p>Setting range: 0.00Hz–P00.03 (max. output frequency)</p>	0.00Hz	○
P08.37	Enable/disable energy-consumption brake	<p>0: Disable energy-consumption 1: Enable energy-consumption</p>	1	○
P08.38	Energy-consumption brake threshold voltage	<p>Set the starting bus voltage of energy-consumption brake, adjust this value properly can brake the load effectively. The default value will change with the change of voltage class. Setting range: 200.0–2000.0V</p>	<p>220V voltage: 380.0V; 380V voltage: 700.0V;</p>	○
P08.39	Running mode of cooling fan	<p>0: Common running mode 1: The fan keeps running after power up 2. Running mode 2</p>	0	○
P08.40	PWM selection	<p>0x0000–0x1121 Ones place: PWM mode selection 0: PWM mode 1, 3PH modulation and 2PH modulation 1: PWM mode 2, 3PH modulation Tens place: PWM low-speed carrier limit 0: Low-speed carrier limit mode 1 1: Low-speed carrier limit mode 2 2: No limit</p>	0x1101	◎

Function code	Name	Detailed parameter description	Default value	Modify
		<p>Hundreds place: Deadzone compensation method</p> <p>0: Compensation method 1</p> <p>1: Compensation method 2</p> <p>Thousands place: PWM loading mode selection</p> <p>0: Interruptive loading</p> <p>1: Normal loading</p>		
P08.41	Overmodulation selection	<p>0x00–0x1111</p> <p>Ones place:</p> <p>0: Disable overmodulation</p> <p>1: Enable overmodulation</p> <p>Tens place</p> <p>0: Mild overmodulation</p> <p>1: Deepened overmodulation</p> <p>Hundreds: Carrier frequency limit</p> <p>0: Yes</p> <p>1: No</p> <p>Thousands: Output voltage compensation</p> <p>0: No</p> <p>1: Yes</p>	0001	⊙
P08.42	Reserved	/	/	/
P08.43	Reserved	/	/	/
P08.44	UP/DOWN terminal control setup	<p>0x000–0x221</p> <p>Ones: Frequency control selection</p> <p>0: UP/DOWN terminal setup is valid</p> <p>1: UP/DOWN terminal setup is invalid</p> <p>Tens: Frequency control selection</p> <p>0: Valid only when P00.06=0 or P00.07=0</p> <p>1: All frequency modes are valid</p> <p>2: Invalid for multi-step speed when multi-step speed takes priority</p> <p>Hundreds: Action selection during stop</p> <p>0: Valid</p> <p>1: Valid during running, clear after stop</p> <p>2: Valid during running, clear after receiving stop command</p>	0x000	○
P08.45	UP terminal frequency incremental integral rate	0.01–50.00Hz/s	0.50Hz/s	○

Function code	Name	Detailed parameter description	Default value	Modify
P08.46	DOWN terminal frequency decremental change rate	0.01–50.00Hz/s	0.50Hz/s	<input type="radio"/>
P08.47	Action selection for frequency setup during power down	0x000–0x111 Ones place: Action selection at power-off during frequency adjusting through digitals. 0: Save the setting at power-off. 1: Clear the setting at power-off. Action selection at power-off during frequency adjusting through Modbus communication 0: Save the setting at power-off. 1: Clear the setting at power-off. Hundreds place: Action selection at power-off during frequency adjusting through DP communication 0: Save the setting at power-off. 1: Clear the setting at power-off.	0x000	<input type="radio"/>
P08.48	High bit of initial value of power consumption	Set the initial value of power consumption. Initial value of power consumption= P08.48 ×1000+	0°	<input type="radio"/>
P08.49	Low bit of initial value of power consumption	P08.49 Setting range of P08.48 : 0–59999 kWh (k) Setting range of P08.49 : 0.0–999.9 kWh	0.0°	<input type="radio"/>
P08.50	Flux braking	This function code is used to enable flux braking function. 0: Invalid 100–150: The larger the coefficient, the stronger the brake intensity The VFD enables motor to decelerate quickly by increasing the motor flux which converts energy generated during braking into thermal energy. The VFD monitors motor state continuously even during flux braking, thus flux braking can be applied in motor stop or used to change motor speed. The flux braking also carries the following advantages.	0	<input type="radio"/>

Function code	Name	Detailed parameter description	Default value	Modify
		1) Brake immediately after sending stop command, removing the need to wait for flux to attenuate. 2) Better cooling effect. During flux braking, the stator current of the motor increases, while the rotor current does not change, while the cooling effect of stator is much more effective than that of the rotor.		
P08.51	Current regulation coefficient on input side	This function code is used to adjust the current display value on the AC input side. 0.00–1.00	0.56	<input type="radio"/>
P08.52	STO lock	0: STO alarm lock Alarm-lock means STO alarm must be reset after state restoration when STO occurs. 1: STO alarm unlock Alarm-unlock means when STO occurs, after state restoration, STO alarm will disappear automatically.	0	<input type="radio"/>
P08.53	Bias value of upper limit frequency of torque control	0.00 Hz– P00.03 (max. output frequency)	0.00Hz	<input type="radio"/>
P08.54	Acceleration/deceleration selection of upper limit frequency of torque control	0: No limit on acceleration or deceleration 1: Acceleration/deceleration time 1 2: Acceleration/deceleration time 2 3: Acceleration/deceleration time 3 4: Acceleration/deceleration time 4	0	<input type="radio"/>

P09—PID control

Function code	Name	Detailed parameter description	Default value	Modify
P09.00	PID reference source	When frequency command (P00.06 , P00.07) is set to 7, or channel of voltage setup (P04.27) is set to 6, the VFD running mode is process PID control. This parameter determines the target reference	0	<input type="radio"/>

Function code	Name	Detailed parameter description	Default value	Modify
		<p>channel of process PID.</p> <p>0: Keypad (P09.01)</p> <p>1: AI1</p> <p>2: AI2</p> <p>3: AI3</p> <p>4: High-speed pulse HDIA</p> <p>5: Multi-step</p> <p>6: Modbus communication</p> <p>7: PROFIBUS/CANopen/DeviceNet communication</p> <p>8: Ethernet communication</p> <p>9: High-speed pulse HDIB</p> <p>10: EtherCAT/PROFINET communication</p> <p>11: Programmable extension card</p> <p>12: Reserved</p> <p>The set target value of process PID is relative value, the set 100% corresponds to 100% of the feedback signal of controlled system.</p> <p>The system operates based on the relative value (0–100.0%)</p>		
P09.01	Pre-set PID reference of keypad	<p>Users need to set this parameter when P09.00 is set to 0, the reference value of this parameter is the feedback variable of the system.</p> <p>Setting range: -100.0%–100.0%</p>	0.0%	○
P09.02	PID feedback source	<p>This parameter is used to select PID feedback channel.</p> <p>0: AI1</p> <p>1: AI2</p> <p>2: AI3</p> <p>3: High-speed pulse HDIA</p> <p>4: Modbus communication</p> <p>5: PROFIBUS/CANopen/DeviceNet communication</p> <p>6: Ethernet communication</p> <p>7: High-speed pulse HDIB</p> <p>8: EtherCAT/PROFINET communication</p> <p>9: Programmable extension card</p> <p>10: Reserved</p> <p>Note: The reference channel and feedback channel cannot overlap; otherwise, PID cannot be controlled effectively.</p>	0	○

Function code	Name	Detailed parameter description	Default value	Modify
P09.03	PID output characteristics	0: PID output is positive characteristic: namely, the feedback signal is larger than the PID reference, which requires the VFD output frequency to decrease for PID to reach balance, eg, tension PID control of winding 1: PID output is negative characteristics: namely the feedback signal is less than PID reference, which requires VFD output frequency to increase for PID to reach balance, eg, tension PID control of unwinding.	0	<input type="radio"/>
P09.04	Proportional gain (Kp)	This function code is suitable for proportional gain P of PID input. It determines the regulation intensity of the whole PID regulator, the larger the value of P, the stronger the regulation intensity. If this parameter is 100, it means when the deviation between PID feedback and reference is 100%, the regulation amplitude of PID regulator (ignoring integral and differential effect) on output frequency command is the max. frequency (ignoring integral and differential actions). Setting range: 0.00–100.00	1.80	<input type="radio"/>
P09.05	Integral time (Ti)	This parameter determines the speed of PID adjustor to carry out integral adjustment on the deviation between PID feedback and reference. When the deviation between PID feedback and reference is 100%, the integral adjustor works continuously after the time (ignoring the proportional effect and differential effect) to achieve the max. output frequency (P00.03) or the max. voltage (P04.31). Shorter the integral time is, stronger the regulation intensity is. Setting range: 0.00–10.00s	0.90s	<input type="radio"/>
P09.06	Differential time (Td)	This parameter determines the strength of the change ratio when PID carries out integral adjustment on the deviation of PID feedback and reference. If the PID feedback changes by 100% during this	0.00s	<input type="radio"/>

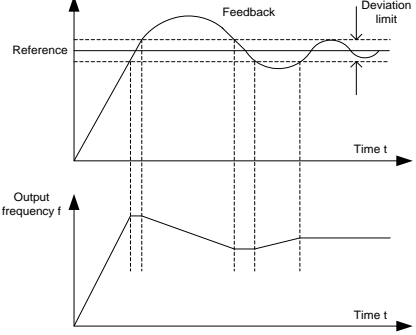

Function code	Name	Detailed parameter description	Default value	Modify
		period, the adjustment of differential regulator (ignoring the proportional effect and differential effect) is the max. output frequency (P00.03) or the max. voltage (P04.31). Longer the derivative time is, stronger the regulation intensity is. Setting range: 0.00–10.00s		
P09.07	Sampling cycle (T)	It means the sampling cycle of feedback. The regulator operates once during each sampling cycle. The larger the sampling cycle, the slower the response. Setting range: 0.001–10.000s	0.001s	○
P09.08	Limit of PID control deviation	It is the max. allowable deviation of PID system output value relative to closed-loop reference value. Within this limit, PID regulator stops regulation. Set this function code properly to regulate the precision and stability of PID system.  Setting range: 0.0–100.0%	0.0%	○
P09.09	Upper limit value of PID output	These two function codes are used to set the upper/lower limit value of PID regulator.	100.0%	○
P09.10	Lower limit value of PID output	100.0% corresponds to max. output frequency (P00.03) or max. voltage (P04.31) Setting range of P09.09: P09.10–100.0% Setting range of P09.10: -100.0%–P09.09	0.0%	○
P09.11	Feedback offline detection value	Set PID feedback offline detection value, when the detection value is no more than the feedback offline	0.0%	○
P09.12	Feedback offline detection time	detection value, and the duration exceeds the value set in P09.12, the VFD will report "PID feedback	1.0s	○

Function code	Name	Detailed parameter description	Default value	Modify
		<p>offline fault", and keypad displays PIDE.</p> <p>Setting range of P09.11: 0.0–100.0%</p> <p>Setting range of P09.12: 0.0–3600.0s</p>		
P09.13	PID control selection	<p>0x0000–0x1111</p> <p>Ones:</p> <ul style="list-style-type: none"> 0: Continue integral control after the frequency reaches upper/lower limit 1: Stop integral control after the frequency reaches upper/lower limit <p>Tens:</p> <ul style="list-style-type: none"> 0: The same with the main reference direction 1: Contrary to the main reference direction <p>Hundreds:</p> <ul style="list-style-type: none"> 0: Limit based on the max. frequency 1: Limit based on A frequency <p>Thousands:</p> <ul style="list-style-type: none"> 0: A+B frequency, acceleration /deceleration of main reference A frequency source buffering is invalid 1: A+B frequency, acceleration/ deceleration of main reference A frequency source buffering is valid, acceleration and deceleration are determined by P08.04 (Acceleration time 4). 	0x0001	<input type="radio"/>
P09.14	Low-frequency proportional gain (Kp)	<p>0.00–100.00</p> <p>Low-frequency switching point: 5.00Hz, high-frequency switching point: 10.00Hz (P09.04 corresponds to high-frequency parameter), and the middle is the linear interpolation between these two points</p>	1.00	<input type="radio"/>
P09.15	Acceleration/ deceleration time of PID command	0.0–1000.0s	0.0s	<input type="radio"/>

Function code	Name	Detailed parameter description	Default value	Modify
P09.16	Filter time of PID output	0.000–10.000s	0.000s	<input type="radio"/>
P09.17	Reserved	-100.0–100.0%	0.0%	<input type="radio"/>
P09.18	Low-frequency integral time (Ti)	0.00–10.00s	0.90s	<input type="radio"/>
P09.19	Low-frequency differential time (Td)	0.00–10.00s	0.00s	<input type="radio"/>
P09.20	Low-frequency point of PID parameter switching	0.00–P09.21	5.00Hz	<input type="radio"/>
P09.21	High-frequency point of PID parameter switching	P09.20–P00.04	10.00Hz	<input type="radio"/>
P09.22–P09.28	Reserved	0–65536	0	<input type="radio"/>

P10—Simple PLC and multi-step speed control

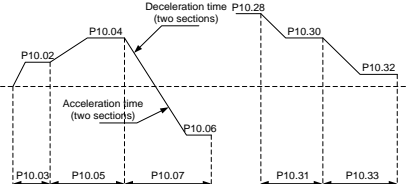
Function code	Name	Detailed parameter description	Default value	Modify
P10.00	Simple PLC mode	0: Stop after running once; the VFD stops automatically after running for one cycle, and it can be started only after receiving running command. 1: Keep running in the final value after running once; The VFD keeps the running frequency and direction of the last section after a single cycle. 2: Cyclic running; the VFD enters the next cycle after completing one cycle until receiving stop command and stops.	0	<input type="radio"/>
P10.01	Simple PLC memory selection	0: No memory after power down 1: Memory after power down; PLC memories its running stage and running frequency before power down.	0	<input type="radio"/>
P10.02	Multi-step speed 0	Setting range of the frequency in 0 th –15 th sections are -100.0–100.0%, 100% corresponds to max. output frequency P00.03 .	0.0%	<input type="radio"/>
P10.03	Running time of 0 th step		0.0s(min)	<input type="radio"/>

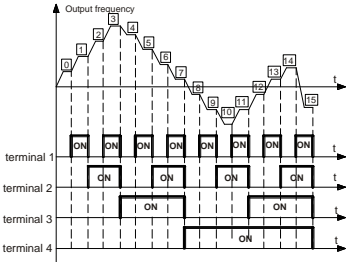
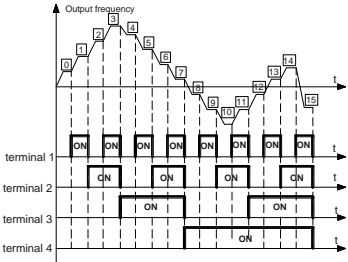
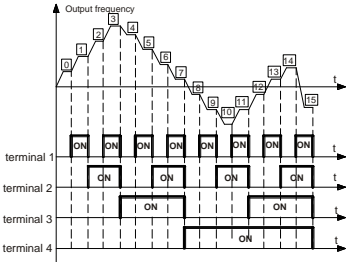
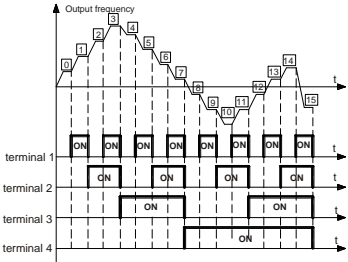
Function code	Name	Detailed parameter description	Default value	Modify
P10.04	Multi-step speed 1	Setting range of the running time in 0 th –15 th sections are 0.0–6553.5s (min), the time unit is determined by P10.37 .	0.0%	<input type="radio"/>
P10.05	Running time of 1 st step		0.0s(min)	<input type="radio"/>
P10.06	Multi-step speed 2	When simple PLC operation is selected, it is required to set P10.02–P10.33 to determine the running frequency and running time of each section.	0.0%	<input type="radio"/>
P10.07	Running time of 2 nd step		0.0s(min)	<input type="radio"/>
P10.08	Multi-step speed 3	Note: The symbol of multi-step speed determines the running direction of simple PLC, and the negative value means reverse running.	0.0%	<input type="radio"/>
P10.09	Running time of 3 rd step		0.0s(min)	<input type="radio"/>
P10.10	Multi-step speed 4		0.0%	<input type="radio"/>
P10.11	Running time of 4 th step		0.0s(min)	<input type="radio"/>
P10.12	Multi-step speed 5		0.0%	<input type="radio"/>
P10.13	Running time of 5 th step		0.0s(min)	<input type="radio"/>
P10.14	Multi-step speed 6	When selecting multi-step speed running, the multi-step speed is within the range of -fmax–fmax, and it can be set continuously. The start/stop of multi-step stop is also determined by P00.01 .	0.0%	<input type="radio"/>
P10.15	Running time of 6 th step	The Goodrive350 IP54 high-ingress protection series VFD can set 16-step speed, which are set by combined codes of multi-step terminals 1–4 (set by S terminal, correspond to function code P05.01–P05.06) and correspond to multi-step speed 0 to multi-step speed 15.	0.0s(min)	<input type="radio"/>
P10.16	Multi-step speed 7		0.0%	<input type="radio"/>
P10.17	Running time of 7 th step		0.0s(min)	<input type="radio"/>
P10.18	Multi-step speed 8	When terminal 1, terminal 2, terminal 3 and terminal 4 are OFF, the frequency input mode is set by P00.06 or P00.07 . When terminal 1, terminal 2, terminal 3 and terminal 4 are not all	0.0%	<input type="radio"/>
P10.19	Running time of 8 th step		0.0s(min)	<input type="radio"/>
P10.20	Multi-step speed 9		0.0%	<input type="radio"/>
P10.21	Running time of 9 th step		0.0s(min)	<input type="radio"/>
P10.22	Multi-step speed 10	When terminal 1, terminal 2, terminal 3 and terminal 4 are OFF, the frequency input mode is set by P00.06 or P00.07 . When terminal 1, terminal 2, terminal 3 and terminal 4 are not all	0.0%	<input type="radio"/>
P10.23	Running time of 10 th step		0.0s(min)	<input type="radio"/>
P10.24	Multi-step speed 11		0.0%	<input type="radio"/>
P10.25	Running time of 11 th step		0.0s(min)	<input type="radio"/>
P10.26	Multi-step speed 12		0.0%	<input type="radio"/>
			0.0%	<input type="radio"/>

Function code	Name	Detailed parameter description	Default value	Modify											
P10.27	Running time of 12 th step	OFF, the frequency set by multi-step speed will prevail, and the priority of multi-step setting is higher than that of the keypad, analog, high-speed pulse, PID, and communication settings. The relation between terminal 1, terminal 2, terminal 3 and terminal 4 are shown in the table below.	0.0s(min)	○											
P10.28	Multi-step speed 13		0.0%	○											
P10.29	Running time of 13 th step		0.0s(min)	○											
P10.30	Multi-step speed 14		0.0%	○											
P10.31	Running time of 14 th step		0.0s(min)	○											
P10.32	Multi-step speed 15		0.0%	○											
P10.33	Running time of 15 th step		Terminal 1	OFF	ON	OFF	ON	OFF	ON	OFF	ON	0.0s(min)	○		
			Terminal 2	OFF	OFF	ON	ON	OFF	OFF	ON	ON				
		Terminal 3	OFF	OFF	OFF	OFF	ON	ON	ON	ON					
		Terminal 4	OFF	OFF	OFF	OFF	OFF	OFF	OFF	OFF					
		Step	0	1	2	3	4	5	6	7					
P10.34	Acceleration/deceleration time of 0 th – 7 th step of simple PLC	Terminal 1	OFF	ON	OFF	ON	OFF	ON	OFF	ON	0x0000	○			
		Terminal 2	OFF	OFF	ON	ON	OFF	OFF	ON	ON					
		Terminal 3	OFF	OFF	OFF	OFF	ON	ON	ON	ON					
		Terminal 4	ON	ON	ON	ON	ON	ON	ON	ON					
		Step	8	9	10	11	12	13	14	15					
P10.35	Acceleration/deceleration time of 8 th – 15 th step of simple PLC	Detailed illustration is shown in the table below.										0x0000	○		
		Function code	Binary		Step number	ACC/DEC time 1	ACC/DEC time 2	ACC/DEC time 3	ACC/DEC time 4						
		P10.34	BIT1	BIT0	0	00	01	10	11						
			BIT3	BIT2	1	00	01	10	11						
			BIT5	BIT4	2	00	01	10	11						
			BIT7	BIT6	3	00	01	10	11						
			BIT9	BIT8	4	00	01	10	11						
			BIT11	BIT10	5	00	01	10	11						
			BIT13	BIT12	6	00	01	10	11						
			BIT15	BIT14	7	00	01	10	11						
		P10.35	BIT1	BIT0	8	00	01	10	11						
			BIT3	BIT2	9	00	01	10	11						
			BIT5	BIT4	10	00	01	10	11						
			BIT7	BIT6	11	00	01	10	11						
			BIT9	BIT8	12	00	01	10	11						
BIT11	BIT10		13	00	01	10	11								
BIT13	BIT12		14	00	01	10	11								
BIT15	BIT14		15	00	01	10	11								

Function code	Name	Detailed parameter description	Default value	Modify
		Select corresponding acceleration/deceleration time, and then convert 16-bit binary number into hexadecimal number, finally, set corresponding function code. Acceleration/deceleration time 1 is set by P00.11 and P00.12 ; Acceleration/deceleration time 2 is set by P08.00 and P08.01 ; Acceleration/deceleration time 3 is set by P08.02 and P08.03 ; Acceleration /deceleration time 4 is set by P08.04 and P08.05 . Setting range: 0x0000–0xFFFF		
P10.36	PLC restart mode	0: Restart from the first step, namely if the VFD stops during running (caused by stop command, fault or power down), it will run from the first step after restart. 1: Continue running from the step frequency when interruption occurred, namely if the VFD stops during running (caused by stop command or fault), it will record the running time of current step, and enters this step automatically after restart, then continue running at the frequency defined by this step in the remaining time.	0	⊙
P10.37	Multi-step time unit	0: s; the running time of each step is counted in seconds; 1: min; the running time of each step is counted in minutes;	0	⊙

P11—Protection parameters

Function code	Name	Detailed parameter description	Default value	Modify
P11.00	Phase-loss protection	0x000–0x111 Ones: 0: Disable software input phase loss protection 1: Enable software input phase loss protection Tens: 0: Disable output phase loss protection	0x110	○

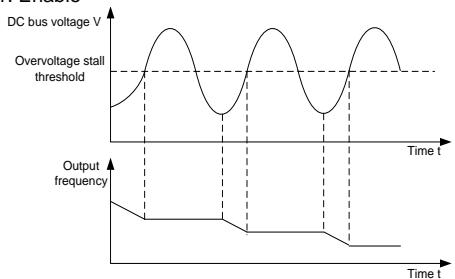
Function code	Name	Detailed parameter description	Default value	Modify
		1: Enable output phase loss protection Hundreds: 0: Disable hardware input phase loss protection 1: Enable hardware input phase loss protection		
P11.01	Frequency-drop at transient power down	0: Disable 1: Enable	0	<input type="radio"/>
P11.02	Energy braking for stop	0: Enable 1: Disable	0	<input checked="" type="radio"/>
P11.03	Overvoltage stall protection	0: Disable 1: Enable 	1	<input type="radio"/>
P11.04	Overvoltage stall protection voltage	120–150% (standard bus voltage) (380V)	136%	<input type="radio"/>
		120–150% (standard bus voltage) (220V)	120%	
P11.05	Current-limit selection	During accelerated running, as the load is too large, the actual acceleration rate of motor is lower than that of output frequency, if no measures are taken, the VFD may trip due to overcurrent during acceleration. 0x00–0x11 Ones: Current-limit action selection 0: Invalid 1: Always valid Tens: Hardware current-limit overload alarm selection 0: Valid 1: Invalid	01	<input checked="" type="radio"/>

Function code	Name	Detailed parameter description	Default value	Modify
P11.06	Automatic current-limit level	Current-limit protection function detects output current during running, and compares it with the current-limit level defined by P11.06 , if it exceeds the current-limit level, the VFD will run at stable frequency during accelerated running, or run in decreased frequency during constant-speed running; if it exceeds the current-limit level continuously, the VFD output frequency will drop continuously until reaching lower limit frequency. When the output current is detected to be lower than the current-limit level again, it will continue accelerated running.	G model: 160.0% P model: 120.0%	☉
P11.07	Frequency-drop rate during current limit	<p>Setting range of P11.06: 50.0–200.0% Setting range of P11.07: 0.00–50.00Hz/s</p>	10.00 Hz/s	☉
P11.08	VFD or motor overload/underload pre-alarm	<p>0x000–0x1132</p> <p>Ones place:</p> <ul style="list-style-type: none"> 0: Motor overload/underload pre-alarm, relative to rated motor current 1: VFD overload/underload pre-alarm, relative to rated VFD current <p>Tens place:</p> <ul style="list-style-type: none"> 0: The VFD continues running after overload/underload alarm. 1: The VFD continues running after underload alarm, and stops running after overload fault. 2: The VFD continues running after overload alarm, and stops running after underload fault. 3: The VFD stops running after overload/underload fault. 	0x000	○

Function code	Name	Detailed parameter description	Default value	Modify
		<p>Hundreds place: 0: Always detect 1: Detect during constant-speed running</p> <p>Thousands place: VFD overload current reference selection 0: Related to current calibration coefficient 1: Irrelated to current calibration coefficient</p>		
P11.09	Overload pre-alarm detection level	<p>If the VFD or motor output current is larger than the overload pre-alarm detection level (P11.09), and the duration exceeds the overload pre-alarm detection time (P11.10), overload pre-alarm signal will be outputted.</p>	<p>G model: 150% P model: 120%</p>	<input type="radio"/>
P11.10	Overload pre-alarm detection time	<p>Setting range of P11.09: P11.11–200% Setting range of P11.10: 0.1–3600.0s</p>	1.0s	<input type="radio"/>
P11.11	Underload pre-alarm detection level	<p>Underload pre-alarm signal will be outputted if the output current of the VFD or motor is lower than underload pre-alarm detection level (P11.11), and the duration exceeds underload pre-alarm detection time (P11.12).</p>	50%	<input type="radio"/>
P11.12	Underload pre-alarm detection time	<p>Setting range of P11.11: 0– P11.09 Setting range of P11.12: 0.1–3600.0s</p>	1.0s	<input type="radio"/>
P11.13	Fault output terminal action during fault	<p>This function code is used to set the action of fault output terminals during undervoltage and fault reset. 0x00–0x11 Ones: 0: Act during undervoltage fault 1: Do not act during undervoltage fault</p>	0x00	<input type="radio"/>

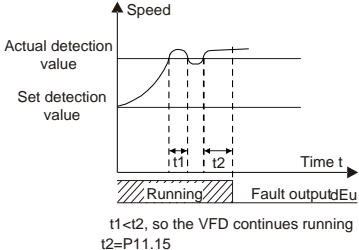
Function code	Name	Detailed parameter description	Default value	Modify
		<p>Tens:</p> <p>0: Act during fault reset</p> <p>1: Do not act during fault reset</p>		
P11.14	Speed deviation detection value	<p>0.0–50.0%</p> <p>This parameter is used to set the speed deviation detection value.</p>	10.0%	<input type="radio"/>
P11.15	Speed deviation detection time	<p>This parameter is used to set the speed deviation detection time.</p> <p>Note: Speed deviation protection will be invalid if P11.15 is set to 0.0.</p>  <p>Setting range: 0.0–10.0s</p>	2.0s	<input type="radio"/>
P11.16	Automatic frequency-reduction during voltage drop	<p>0–1</p> <p>0: Invalid</p> <p>1: Valid</p>	0	<input type="radio"/>
P11.17	Proportional coefficient of voltage regulator during undervoltage stall	0–1000	100	<input type="radio"/>
P11.18	Integral coefficient of voltage regulator during undervoltage stall	0–1000	40	<input type="radio"/>
P11.19	Proportional coefficient of current regulator during undervoltage stall	0–1000	25	<input type="radio"/>

Function code	Name	Detailed parameter description	Default value	Modify
P11.20	Integral coefficient of current regulator during undervoltage stall	0–2000	150	○
P11.21	Proportional coefficient of voltage regulator during overvoltage stall	0–1000	60	○
P11.22	Integral coefficient of voltage regulator during overvoltage stall	0–1000	10	○
P11.23	Proportional coefficient of current regulator during overvoltage stall	0–1000	60	○
P11.24	Integral coefficient of current regulator during overvoltage stall	0–2000	250	○
P11.25	Enable VFD overload integral	0: Disable 1: Enable	0	
P11.26	Reserved	0–65536	0	○
P11.27	VF vibration control method	0x00–0x11 Ones place: 0: Method 1 1: Method 2 Tens place: 0: Reserved 1: Reserved	0x00	◎
P11.26– P11.27	Reserved variables	0–65536	0	○

P12—Parameters of motor 2

Function code	Name	Description	Default value	Modify
P12.00	Type of motor 2	0: Asynchronous motor 1: Synchronous motor	0	☉
P12.01	Rated power of asynchronous motor 2	0.1–3000.0kW	Depends on model	☉
P12.02	Rated frequency of asynchronous motor 2	0.01Hz–P00.03 (Max. output frequency)	50.00Hz	☉
P12.03	Rated speed of asynchronous motor 2	1–60000rpm	Depends on model	☉
P12.04	Rated voltage of asynchronous motor 2	0–1200V	Depends on model	☉
P12.05	Rated current of asynchronous motor 2	0.8–6000.0A	Depends on model	☉
P12.06	Stator resistance of asynchronous motor 2	0.001–65.535Ω	Depends on model	○
P12.07	Rotor resistance of asynchronous motor 2	0.001–65.535Ω	Depends on model	○
P12.08	Leakage inductance of asynchronous motor 2	0.1–6553.5mH	Depends on model	○
P12.09	Mutual inductance of asynchronous motor 2	0.1–6553.5mH	Depends on model	○
P12.10	No-load current of asynchronous motor 2	0.1–6553.5A	Depends on model	○

Function code	Name	Description	Default value	Modify
P12.11	Magnetic saturation coefficient 1 of iron core of asynchronous motor 2	0.0–100.0%	80%	<input type="radio"/>
P12.12	Magnetic saturation coefficient 2 of iron core of asynchronous motor 2	0.0–100.0%	68%	<input type="radio"/>
P12.13	Magnetic saturation coefficient 3 of iron core of asynchronous motor 2	0.0–100.0%	57%	<input type="radio"/>
P12.14	Magnetic saturation coefficient 4 of iron core of asynchronous motor 2	0.0–100.0%	40%	<input type="radio"/>
P12.15	Rated power of synchronous motor 2	0.1–3000.0kW	Depends on model	<input checked="" type="radio"/>
P12.16	Rated frequency of synchronous motor 2	0.01Hz–P00.03 (Max. output frequency)	50.00Hz	<input checked="" type="radio"/>
P12.17	Number of pole pairs of synchronous motor 2	1–128	2	<input checked="" type="radio"/>
P12.18	Rated voltage of synchronous motor 2	0–1200V	Depends on model	<input checked="" type="radio"/>

Function code	Name	Description	Default value	Modify
P12.19	Rated voltage of synchronous motor 2	0.8–6000.0A	Depends on model	☉
P12.20	Stator resistance of synchronous motor 2	0.001–65.535Ω	Depends on model	○
P12.21	Direct-axis inductance of synchronous motor 2	0.01–655.35mH	Depends on model	○
P12.22	Quadrature-axis inductance of synchronous motor 2	0.01–655.35mH	Depends on model	○
P12.23	Counter-emf constant of synchronous motor 2	0–10000V	300	○
P12.24	Reserved	0–0xFFFF	0x0000	●
P12.25	Reserved	0%–50% (of the rated current of the motor)	10%	●
P12.26	Overload protection of motor 2	0: No protection 1: Common motor (with low-speed compensation) 2: Frequency-variable motor (without low-speed compensation)	2	☉
P12.27	Overload protection coefficient of motor 2	Motor overload multiples $M = I_{out}/(I_n \times K)$ I_n is rated motor current, I_{out} is VFD output current, K is motor overload protection coefficient. The smaller the K , the larger the value of M , the easier the protection. if M is 116%, protection will be applied when motor overloads for 1h; if M is 200%, protection will be applied when motor overloads for 60s; if M is no less than 400%, protection will be applied immediately.	100.0%	○

Function code	Name	Description	Default value	Modify
		<p>Setting range: 20.0%–120.0%</p>		
P12.28	Power display calibration coefficient of motor 2	0.00–3.00	1.00	<input type="radio"/>
P12.29	Parameter display of motor 2	0: Display based on the motor type; under this mode, only parameters related to current motor type will be displayed. 1: Display all; under this mode, all the parameters will be displayed.	0	<input type="radio"/>
P12.30	System inertia of motor 2	0–30.000kgm ²	0.000	<input type="radio"/>
P12.31–P12.32	Reserved	0–65535	0	<input type="radio"/>

P13—Control parameters of synchronous motor

Function code	Name	Description	Default value	Modify
P13.00	Reduction rate of the injection current of synchronous motor	This parameter is used to set the reduction rate of the input reactive current. When the active current of the synchronous motor increases to some extent, the input reactive current can be reduced to improve the power factor of the motor. Setting range: 0.0%–100.0% (of the rated current of the motor)	80.0%	<input type="radio"/>
P13.01	Initial pole detection mode	0: No detection 1: High-frequency current injection 2: Pulse superimposition	0	<input checked="" type="radio"/>
P13.02	Pull-in current 1	Input current is the pole position orientation current; input current 1 is valid within the lower	20.0%	<input type="radio"/>

Function code	Name	Description	Default value	Modify
		limit of input current switch-over frequency threshold. If you need to increase the starting torque, increase the value of this function code properly. Setting range: 0.0%–100.0% (rated motor current)		
P13.03	Pull-in current 2	Input current is the pole position orientation current; input current 2 is valid within the upper limit of input current switch-over frequency threshold, and you do not need to change input current 2 under common situations. Setting range: 0.0%–100.0% (rated motor current)	10.0%	<input type="radio"/>
P13.04	Switch-over frequency of input current	0.00Hz–P00.03 (Max. output frequency)	10.00Hz	<input type="radio"/>
P13.05	High-frequency superposition frequency (reserved)	200Hz–1000Hz	500Hz	<input checked="" type="radio"/>
P13.06	Pulse current setting	This parameter is used to set the pulse current threshold when the initial magnetic pole position is detected in the pulse mode. The value is a percentage in relative to the rated current of the motor. Setting range: 0.0–300.0% (of the rated voltage of the motor)	100.0%	<input checked="" type="radio"/>
P13.07	Reserved	0.0–400.0	0.0	<input type="radio"/>
P13.08	Control parameter 1	0–0xFFFF	0	<input type="radio"/>
P13.09	Control parameter 2	This parameter is used to set the frequency threshold for enabling the counter-electromotive force phase-locked loop in SVC 0. When the running frequency is lower than the value of this parameter, the phase-locked loop is disabled; and when the running frequency is higher than that, the phase-locked loop is enabled. Setting range: 0–655.35	2.00	<input type="radio"/>
P13.10	Reserved	0.0–359.9	0.0	<input type="radio"/>

Function code	Name	Description	Default value	Modify
P13.11	Maladjustment detection time	This parameter is used to adjust the responsiveness of anti-maladjustment function. If the load inertia is large, increase the value of this parameter properly, however, the responsiveness may slow down accordingly. Setting range: 0.0–10.0s	0.5s	<input type="radio"/>
P13.12	High-frequency compensation coefficient of synchronous motor	This parameter is valid when the motor speed exceeds the rated speed. If motor oscillation occurred, adjust this parameter properly. Setting range: 0.0–100.0%	0.0	<input type="radio"/>
P13.13	High-frequency injection current	0–300.0%	20.0%	<input checked="" type="radio"/>
P13.19	Reserved	0–65535	0	<input type="radio"/>

P14—Serial communication function

Function code	Name	Description	Default value	Modify
P14.00	Local communication address	Setting range: 1–247 When the master is writing frames, and the slave communication address is set to 0, it is the broadcast communication address, and all the slaves on the Modbus bus will accept this frame, but the slave never responds. Local communication address is unique in the communication network, which is the basis for point-to-point communication between the upper computer and the VFD. Note: The slave address cannot be set to 0.	1	<input type="radio"/>
P14.01	Communication baud rate setup	This parameter is used to set the data transmission speed between upper computer and the VFD. 0: 1200BPS 1: 2400BPS 2: 4800BPS 3: 9600BPS 4: 19200BPS	4	<input type="radio"/>

Function code	Name	Description	Default value	Modify
		5: 38400BPS 6: 57600BPS 7: 115200BPS Note: Baud rate of the upper computer must be the same with the VFD; otherwise, communication cannot be performed. The larger the baud rate, the faster the communication speed.		
P14.02	Data bit check setup	The data format of upper computer must be the same with the VFD; otherwise, communication cannot be performed. 0: No parity check (N, 8, 1) for RTU 1: Even parity (E, 8, 1) for RTU 2: Odd parity (O, 8, 1) for RTU 3: No parity check (N, 8, 2) for RTU 4: Even parity (E, 8, 2) for RTU 5: Odd parity (O, 8, 2) for RTU	1	○
P14.03	Communication response delay	0–200ms It refers to the time interval from when the data is received by the VFD to the moment when the data is sent to the upper computer. If the response delay is less than the system processing time, the response delay will be subject to system processing time; if the response delay is longer than the system processing time, data will be sent to the upper computer at a delay after data process is done by system.	5	○
P14.04	Communication timeout period	0.0 (invalid) –60.0s This parameter will be invalid if it is set to 0.0; When it is set to a non-zero value, if the time interval between current communication and the next communication exceeds the communication timeout period, the system will report "485 communication fault" (CE). Under common situations, it is set to 0.0. In systems which have continuous communication, you can monitor the communication condition by setting this parameter.	0.0s	○

Function code	Name	Description	Default value	Modify
P14.05	Transmission error processing	0: Alarm and coast to stop 1: Do not alarm and continue running 2: Do not alarm and stop as per the stop mode (under communication control mode only) 3: Do not alarm and stop as per the stop mode (under all control modes)	0	<input type="radio"/>
P14.06	Communication processing action	0x00–0x11 Ones: 0: Write operation has response 1: Write operation has no response Tens: 0: Communication password protection is invalid 1: Communication password protection is valid	0x00	<input type="radio"/>
P14.07– P14.24	Reserved	0–65535	0	<input checked="" type="radio"/>

P15—Functions of communication extension card 1

Function code	Name	Description	Default value	Modify
P15.00– P15.27	See the operation manual of communication extension card for details			
P15.28	Master/slave CAN communication address	0–127	1	<input checked="" type="radio"/>
P15.29	Master/slave CAN communication baud rate selection	0: 50Kbps 1: 100 Kbps 2: 125Kbps 3: 250Kbps 4: 500Kbps 5: 1M bps	2	<input checked="" type="radio"/>
P15.30	Master/slave CAN communication timeout period	0.0 (invalid)–300.0s	0.0s	<input type="radio"/>
P15.31– P15.69	See the operation manual of communication extension card for details			

P16—Functions of communication extension card 2

Function code	Name	Description	Default value	Modify
P16.00– P16.23	See the operation manual of communication extension card for details			
P16.24	Identification time for the extension card in card slot 1	0.0–600.0s If it is set to 0.0, identification fault will not be detected	0.0s	<input type="radio"/>
P16.25	Identification time for the extension card in card slot 2	0.0–600.0s If it is set to 0.0, offline fault will not be detected	0.0s	<input type="radio"/>
P16.26	Identification time for the extension card in card slot 3	0.0–600.0s If it is set to 0.0, offline fault will not be detected	0.0s	<input type="radio"/>
P16.27	Communication timeout period of extension card in card slot 1	0.0–600.0s If it is set to 0.0, offline fault will not be detected	0.0s	<input type="radio"/>
P16.28	Communication timeout period of extension card in card slot 2	0.0–600.0s If it is set to 0.0, offline fault will not be detected	0.0s	<input type="radio"/>
P16.29	Communication timeout period of extension card in card slot 3	0.0–600.0s If it is set to 0.0, offline fault will not be detected	0.0s	<input type="radio"/>
P16.30– P16.69	See the operation manual of communication extension card for details			

P17—State-check functions

Function code	Name	Description	Default value	Modify
P17.00	Set frequency	Display current set frequency of the VFD. Range: 0.00Hz–P00.03	50.00Hz	<input checked="" type="radio"/>
P17.01	Output frequency	Display current output frequency of the VFD. Range: 0.00Hz–P00.03	0.00Hz	<input checked="" type="radio"/>

Function code	Name	Description	Default value	Modify
P17.02	Ramp reference frequency	Display current Ramp reference frequency of the VFD. Range: 0.00Hz–P00.03	0.00Hz	●
P17.03	Output voltage	Display current output voltage of the VFD. Range: 0–1200V	0V	●
P17.04	Output current	Display the valid value of current output current of the VFD. Range: 0.0–5000.0A	0.0A	●
P17.05	Motor speed	Display current motor speed. Range: 0–65535RPM	0 RPM	●
P17.06	Torque current	Display current torque current of the VFD. Range: -3000.0–3000.0A	0.0A	●
P17.07	Exciting current	Display current exciting current of the VFD. Range: -3000.0–3000.0A	0.0A	●
P17.08	Motor power	Display current motor power; 100% relative to rated motor power, positive value is motoring state, negative value is generating state. Range: -300.0–300.0% (relative to rated motor power)	0.0%	●
P17.09	Motor output torque	Display current output torque of the VFD; 100% relative to rated motor torque, during forward running, positive value is motoring state, negative value is generating state, during reverse running, positive value is generating state, negative value is motoring state. Range: -250.0–250.0%	0.0%	●
P17.10	Estimated motor frequency	The estimated motor rotor frequency under open-loop vector condition. Range: 0.00– P00.03	0.00Hz	●
P17.11	DC bus voltage	Display current DC bus voltage of the VFD. Range: 0.0–2000.0V	0V	●
P17.12	Digital input terminal state	Display current digital input terminal state of the VFD. 0000–03F Corresponds to HDIB, HDIA, S4, S3, S2 and S1 respectively	0	●

Function code	Name	Description	Default value	Modify
P17.13	Digital output terminal state	Display current digital output terminal state of the VFD. 0000–000F Corresponds to RO2, RO1, HDO and Y1 respectively	0	●
P17.14	Digital adjustment variable	Display the regulating variable by UP/DOWN terminals of the VFD. Range: 0.00Hz–P00.03	0.00Hz	●
P17.15	Torque reference value	Relative to percentage of the rated torque of current motor, display torque reference. Range: -300.0%–300.0% (rated motor current)	0.0%	●
P17.16	Linear speed	0–65535	0	●
P17.17	Reserved	0–65535	0	●
P17.18	Count value	0–65535	0	●
P17.19	AI1 input voltage	Display input signal of AI 1 Range: 0.00–10.00V	0.00V	●
P17.20	AI2 input voltage	Display input signal of AI2 Range: -10.00V–10.00V	0.00V	●
P17.21	HDIA input frequency	Display input frequency of HDIA Range: 0.000–50.000kHz	0.000 kHz	●
P17.22	HDIB input frequency	Display input frequency of HDIB Range: 0.000–50.000kHz	0.000 kHz	●
P17.23	PID reference value	Display PID reference value Range: -100.0–100.0%	0.0%	●
P17.24	PID feedback value	Display PID feedback value Range: -100.0–100.0%	0.0%	●
P17.25	Motor power factor	Display the power factor of current motor. Range: -1.00–1.00	1.00	●
P17.26	Current running time	Display current running time of the VFD. Range: 0–65535min	0m	●
P17.27	Actual stage of simple PLC	Displays the present stage of the simple PLC function.	0	●
P17.28	Motor ASR controller output	Display the speed loop ASR controller output value under vector control mode, relative to the percentage of rated torque of the motor. Range: -300.0%–300.0% (rated motor current)	0.0%	●

Function code	Name	Description	Default value	Modify
P17.29	Pole angle of open-loop synchronous motor	Display initial identification angle of synchronous motor Range: 0.0–360.0	0.0	●
P17.30	Phase compensation of synchronous motor	Display phase compensation of synchronous motor Range: -180.0–180.0	0.0	●
P17.31	High-frequency superposition current of synchronous motor	0.0%–200.0% (rated motor current)	0.0	●
P17.32	Motor flux linkage	0.0%–200.0%	0.0%	●
P17.33	Exciting current reference	Display the exciting current reference value under vector control mode Range: -3000.0–3000.0A	0.0A	●
P17.34	Torque current reference	Display torque current reference value under vector control mode Range: -3000.0–3000.0A	0.0A	●
P17.35	AC incoming current	Display the valid value of incoming current on AC side Range: 0.0–5000.0A	0.0A	●
P17.36	Output torque	Display output torque value, during forward running, positive value is motoring state, negative value is generating state; during reverse running, positive value is generating state, negative value is motoring state. Range: -3000.0Nm–3000.0Nm	0.0Nm	●
P17.37	Motor overload count value	0–65535	0	●
P17.38	Process PID output	-100.0%–100.0%	0.00%	●
P17.39	Parameter download wrong function code	0.00–99.00	0.00	●

Function code	Name	Description	Default value	Modify
P17.40	Motor control mode	Ones: Control mode 0: Vector 0 1: Vector 1 2: VF control 3: Closed-loop vector control Tens: Control state 0: Speed control 1: Torque control 2: Position control Hundreds: Motor number 0: Motor 1 1: Motor 2	0x2	●
P17.41	Upper limit of the torque when motoring	0.0%–300.0% (rated motor current)	180.0%	●
P17.42	Upper limit of braking torque	0.0%–300.0% (rated motor current)	180.0%	●
P17.43	Upper limit frequency of forward running of torque control	0.00–P00.03	50.00Hz	●
P17.44	Upper limit frequency of reverse running of torque control	0.00–P00.03	50.00Hz	●
P17.45	Inertia compensation torque	-100.0%–100.0%	0.0%	●
P17.46	Friction compensation torque	-100.0%–100.0%	0.0%	●
P17.47	Motor pole pairs	0–65535	0	●
P17.48	VFD overload count value	0–65535	0	●
P17.49	Frequency set by A source	0.00–P00.03	0.00Hz	●
P17.50	Frequency set by B source	0.00–P00.03	0.00Hz	●

Function code	Name	Description	Default value	Modify
P17.51	PID proportional output	-100.0%–100.0%	0.00%	●
P17.52	PID integral output	-100.0%–100.0%	0.00%	●
P17.53	PID differential output	-100.0%–100.0%	0.00%	●
P17.54– P17.63	Reserved	0–65535	0	●

P18—Closed-loop control state check

Function code	Name	Description	Default value	Modify
P18.00	Actual frequency of encoder	The actual-measured encoder frequency; the value of forward running is positive; the value of reverse running is negative. Range: -999.9–3276.7Hz	0.0Hz	●
P18.01	Encoder position count value	Encoder count value, quadruple frequency, Range: 0–65535	0	●
P18.02	Encoder Z pulse count value	Corresponding count value of encoder Z pulse. Range: 0–65535	0	●
P18.03	High bit of position reference value	High bit of position reference value, zero out after stop. Range: 0–30000	0	●
P18.04	Low bit of position reference value	Low bit of position reference value, zero out after stop. Range: 0–65535	0	●
P18.05	High bit of position feedback value	High bit of position feedback value, zero out after stop. Range: 0–30000	0	●
P18.06	Low bit of position feedback value	Low bit of position feedback value, zero out after stop. Range: 0–65535	0	●
P18.07	Position deviation	Deviation between current reference position and actual running position. Range: -32768–32767	0	●
P18.08	Position of reference point	Position of reference point of Z pulse when the spindle stops accurately. Range: 0–65535	0	●

Function code	Name	Description	Default value	Modify
P18.09	Current position setup of spindle	Current position setup when the spindle stops accurately. Range: 0–359.99	0.00	●
P18.10	Current position when spindle stops accurately	Current position when spindle stops accurately. Range: 0–65535	0	●
P18.11	Encoder Z pulse direction	Z pulse direction display. When the spindle stops accurately, there may be a couple of pulses' error between the position of forward and reverse orientation, which can be eliminated by adjusting Z pulse direction of P20.02 or exchanging phase AB of encoder. 0: Forward 1: Reverse	0	●
P18.12	Encoder Z pulse angle	Reserved. Range: 0.00–359.99	0.00	●
P18.13	Encoder Z pulse error times	Reserved. Range: 0–65535	0	●
P18.14	High bit of encoder pulse count value	0–65535	0	●
P18.15	Low bit of encoder pulse count value	0–65535	0	●
P18.16	Main control board measured speed value	-3276.8–3276.7Hz	0.0Hz	●
P18.17	Pulse command frequency	Pulse command (A2, B2 terminal) is converted to the set frequency, and it is valid under pulse position mode and pulse speed mode. Range: 0–655.35Hz	0.00Hz	●
P18.18	Pulse command feedforward	Pulse command (A2, B2 terminal) is converted to the set frequency, and it is valid under pulse position mode and pulse speed mode. Range: 0–655.35Hz	0.00Hz	●
P18.19	Position regulator output	-327.68–327.67Hz	0.00Hz	●

Function code	Name	Description	Default value	Modify
P18.20	Count value of resolver	Count value of resolver. Range: 0–65535	0	●
P18.21	Resolver angle	The pole position angle read according to the resolver-type encoder. Range: 0.00–359.99	0.00	●
P18.22	Pole angle of closed-loop synchronous motor	Current pole position. Range: 0.00–359.99	0.00	●
P18.23	State control word 3	0–65535	0	●
P18.24	High bit of count value of pulse reference	0–65535	0	●
P18.25	Low bit of count value of pulse reference	0–65535	0	●
P18.26	PG card measured speed value	-3276.8–3276.7Hz	0.0Hz	●
P18.27	Encoder UVW sector	0–7	0	●
P18.28	Encoder PPR (pulse-per-revolution) display	0–65535	0	●
P18.29	Angle compensation value of synchronous motor	-180.0–180.0	0.00	●
P18.30	Reserved	0–65535	0	●
P18.31	Pulse reference Z pulse value	0–65535	0	●
P18.32	Pulse-given main control board measured speed value	-3276.8–3276.7Hz	0.0Hz	●

Function code	Name	Description	Default value	Modify
P18.33	Pulse-given PG card measured speed value	~3276.8~3276.7Hz	0.0Hz	●
P18.34	Present encoder filter width	0~63	0	●
P18.35	Reserved	0~65535	0	●

P19—Extension card state check

Function code	Name	Description	Default value	Modify
P19.00	Type of card at slot 1	0~65535	0	●
P19.01	Type of card at slot 2	0: No card 1: PLC programmable card 2: I/O card	0	●
P19.02	Type of card at slot 3	3: Incremental PG card 4: Incremental PG card with UVW 5: Ethernet communication card 6: DP communication card 7: Bluetooth card 8: Resolver PG card 9: CANopen communication card 10: WIFI card 11: PROFINET communication card 12: Sine/Cosine PG card without CD signal 13: Sine/Cosine PG card with CD signal 14: Absolute encoder PG card 15: CAN master/slave communication card 16: Modbus communication card 17: EtherCAT communication card 18: BacNet communication card 19: DeviceNet communication card	0	●
P19.03	Software version of the extension card in card slot 1	0.00~655.35	0.00	●
P19.04	Software version of the extension card in card slot 2	0.00~655.35	0.00	●

Function code	Name	Description	Default value	Modify
P19.05	Software version of the extension card in card slot 3	0.00–655.35	0.00	●
P19.06	Input state of extension I/O card terminals	0–0xFFFF	0	●
P19.07	Output state of extension I/O card terminals	0–0xFFFF	0	●
P19.08	HDI3 input frequency of extension I/O card	0.000–50.000kHz	0.000 kHz	●
P19.09	AI3 input voltage of extension I/O card	0.00–10.00V	0.00V	●
P19.10–P19.39	Reserved	0–65535	0	●

P20—Encoder of motor 1

Function code	Name	Description	Default value	Modify
P20.00	Encoder type display	0: Incremental encoder 1: Resolver-type encoder 2: Sin/Cos encoder 3: Endat absolute encoder	0	●
P20.01	Encoder pulse number	Number of pulses generated when the encoder revolves for one circle. Setting range: 0–60000	1024	⊙
P20.02	Encoder direction	Ones: AB direction 0: Forward 1: Reverse Tens: Z pulse direction (reserved) 0: Forward 1: Reverse Hundreds: CD/UVW pole signal direction 0: Forward 1: Reverse	0x000	⊙

Function code	Name	Description	Default value	Modify
P20.03	Detection time of encoder offline fault	0.0–10.0s	2.0s	<input type="radio"/>
P20.04	Detection time of encoder reversal fault	0.0–100.0s	0.8s	<input type="radio"/>
P20.05	Filter times of encoder detection	Setting range: 0x00–0x99 Ones: Low-speed filter time, corresponds to $2^{\wedge}(0-9) \times 125\mu\text{s}$. Tens: High-speed filter times, corresponds to $2^{\wedge}(0-9) \times 125\mu\text{s}$.	0x33	<input type="radio"/>
P20.06	Speed ratio between encoder mounting shaft and motor	You need to set this parameter when the encoder is not installed on the motor shaft and the drive ratio is not 1. Setting range: 0.001–65.535	1.000	<input type="radio"/>
P20.07	Control parameters of synchronous motor	Bit0: Enable Z pulse calibration Bit1: Enable encoder angle calibration Bit2: Enable SVC speed measurement Bit3: Select resolver speed measurement mode Bit4: Z pulse capture mode Bit5: Do not detect encoder initial angle in v/f control Bit6: Enable CD signal calibration Bit7: Disable sin/cos sub-division speed measurement Bit8: Do not detect encoder fault during autotuning Bit9: Enable Z pulse detection optimization Bit10: Enable initial Z pulse calibration optimization Bit12: Clear Z pulse arrival signal after stop	0x3	<input type="radio"/>
P20.08	Enable Z pulse offline detection	0x00–0x11 Ones: Z pulse 0: Do not detect 1: Enable Tens: UVW pulse (for synchronous motor) 0: Do not detect 1: Enable	0x10	<input type="radio"/>

Function code	Name	Description	Default value	Modify
P20.09	Initial angle of Z pulse	Relative electric angle of encoder Z pulse and motor pole position. Setting range: 0.00–359.99	0.00	<input type="radio"/>
P20.10	Initial angle of the pole	Relative electric angle of encoder position and motor pole position. Setting range: 0.00–359.99	0.00	<input type="radio"/>
P20.11	Autotuning of initial angle of pole	0–3 1: Rotary autotuning (DC brake) 2: Static autotuning (suitable for resolver-type encoder, sin/cos with CD signal feedback) 3: Rotary autotuning (initial angle identification)	0	<input checked="" type="radio"/>
P20.12	Speed measurement optimization selection	0: No optimization 1: Optimization mode 1 2: Optimization mode 2	1	<input checked="" type="radio"/>
P20.13	CD signal zero offset gain	0–65535	0	<input type="radio"/>
P20.14	Encoder type selection	Ones: Incremental encoder 0: without UVW 1: with UVW Tens: Sin/Cos encoder 0: without CD signal 1: with CD signal	0x00	<input checked="" type="radio"/>
P20.15	Speed measurement mode	0: PG card 1: local; realized by HDIA and HDIB; supports incremental 24V encoder only	0	<input checked="" type="radio"/>
P20.16	Frequency-division on coefficient	0–255 When this parameter is set to 0 or 1, frequency division of 1:1 is implemented.	0	<input type="radio"/>
P20.17	Pulse filter processing	0x0000–0xffff Bit0: Enable/disable encoder input filter 0: No filter 1: Filter Bit1: Encoder signal filter mode (set Bit0 or Bit2 to 1) 0: Self-adaptive filter 1: Use P20.18 filter parameters Bit2: Enable/disable encoder frequency-division	0x0033	<input type="radio"/>

Function code	Name	Description	Default value	Modify
		output filter 0: No filter 1: Filter Bit3: Reserved Bit4: Enable/disable pulse reference filter 0: No filter 1: Filter Bit5: Pulse reference filter mode (valid when Bit4 is set to 1) 0: Self-adaptive filter 1: Use P20.19 filter parameters Bit6: Frequency-divided output source setting 0: Encoder signals 1: Pulse reference signals Bits7–15: Reserved		
P20.18	Encoder pulse filter width	0–63 The filtering time is $P20.18 \times 0.25 \mu s$. The value 0 or 1 indicates $0.25 \mu s$.	2	<input type="radio"/>
P20.19	Pulse reference filter width	0–63 The filtering time is $P20.18 \times 0.25 \mu s$. The value 0 or 1 indicates $0.25 \mu s$.	2	<input type="radio"/>
P20.20	Pulse number of pulse reference	0–65535	1024	<input checked="" type="radio"/>
P20.21	Enable angle compensation of synchronous motor	0–1	0	<input type="radio"/>
P20.22	Switch-over frequency threshold of speed measurement mode	0–630.00Hz Note: This parameter is valid only when P20.12 is set to 0.	1.00Hz	<input type="radio"/>
P20.23	Synchronous motor angle compensation coefficient	-200.0–200.0%	100.0%	<input type="radio"/>
P20.24	Reserved	0–65535	0	<input type="radio"/>

P21—Position control

Function code	Name	Description	Default value	Modify
P21.00	Positioning mode	<p>Ones: Control mode selection 0: Speed control 1: Position control</p> <p>Tens: Position command source 0: Pulse string 1: Digital position</p> <p>2: Positioning of photoelectric switch during stop</p> <p>Hundreds: Position feedback source (reserved, fixed to channel P)</p> <p>0: PG1 1: PG2</p> <p>Thousands: servo mode Bit0: Position deviation mode 0: No deviation 1: With deviation Bit1: Enable/disable servo 0: Disable (The servo can be enabled by terminals.) 1: Enable Bit2: (reserved)</p> <p>Note: In the pulse string or spindle positioning mode, the VFD enters the servo operation mode when there is a valid servo enabling signal. If there is no servo enabling signal, the VFD enter the servo operation mode only after it receives a forward running or reverse running command.</p>	0x0000	○
P21.01	Pulse command mode	<p>Ones: Pulse mode 0: A/B quadrature pulse; A precedes B 1: A: PULSE; B: SIGN</p> <p>If channel B is of low electric level, the edge counts up; if channel B is of high electric level, the edge counts down.</p> <p>2: A: Positive pulse Channel A is positive pulse; channel B needs no wiring</p> <p>3: A/B dual-channel pulse; channel A pulse edge counts up, channel B pulse edge counts down</p>	0x0000	◎

Function code	Name	Description	Default value	Modify
		<p>Tens: Pulse direction</p> <p>Bit0: Set pulse direction</p> <p>0: Forward</p> <p>1: Reverse</p> <p>Bit1: Set pulse direction by running direction</p> <p>0: Disable, and BIT0 is valid;</p> <p>1: Enable</p> <p>Hundreds: Pulse/direction frequency-doubling selection (reserved)</p> <p>0: No frequency-doubling</p> <p>1: Frequency-doubling</p> <p>Thousands: Pulse control selection</p> <p>Bit0: Pulse filter selection</p> <p>0: Inertia filter</p> <p>1: Average moving filter</p> <p>Bit1: Overspeed control</p> <p>0: No control</p> <p>1: Control</p>		
P21.02	APR gain 1	The two automatic position regulator (APR) gains are switched based on the switching mode set in P21.04. When the spindle orientation function is used, the gains are switched automatically, regardless of the setting of P21.04. P21.03 is used for dynamic running, and P21.02 is used for maintaining the locked state. Setting range: 0.0–400.0	20.0	<input type="radio"/>
P21.03	APR gain 2		30.0	<input type="radio"/>
P21.04	Switching mode of position loop gain	This parameter is used to set the APR gain switching mode. To use torque command-based switching, you need to set P21.05; and to use speed command-based switching, you need to set P21.06. 0: No switching 2: Torque command 3: Speed command 3–5: Reserved	0	<input type="radio"/>
P21.05	Torque command level during position gain switch-over	0.0–100.0% (rated motor torque)	10.0%	<input type="radio"/>

Function code	Name	Description	Default value	Modify
P21.06	Speed command level during position gain switch-over	0.0–100.0% (rated motor speed)	10.0%	<input type="radio"/>
P21.07	Smooth filter coefficient during gain switch-over	The smooth filter coefficient during position gain switch-over. Setting range: 0–15	5	<input type="radio"/>
P21.08	Output limit of position controller	The output limit of position regulator, if the limit value is 0, position regulator will be invalid, and no position control can be performed, however, speed control is available. Setting range: 0.0–100.0% (Max. output frequency P00.03)	20.0%	<input type="radio"/>
P21.09	Completion range of positioning	When the position deviation is less than P21.09, and the duration is larger than P21.10, positioning completion signal will be outputted. Setting range: 0–1000	10	<input type="radio"/>
P21.10	Detection time for positioning completion	0.0–1000.0ms	10.0ms	<input type="radio"/>
P21.11	Numerator of position command ratio	Electronic gear ratio, used to adjust the corresponding relation between position command and actual running displacement. Setting range: 1–65535	1000	<input type="radio"/>
P21.12	Denominator of position command ratio	Setting range: 1–65535	1000	<input type="radio"/>
P21.13	Position feedforward gain	0.00–120.00% For pulse string reference only (position control)	100.00	<input type="radio"/>
P21.14	Position feedforward filter time constant	0.0–3200.0ms For pulse string reference only (position control)	3.0ms	<input type="radio"/>
P21.15	Position command filter time constant	The position feedforward filter time constant during pulse string positioning. 0.0–3200.0ms	0.0ms	<input checked="" type="radio"/>
P21.16	Digital positioning mode	Bit0: Positioning mode selection 0: Relative position	0	<input type="radio"/>

Function code	Name	Description	Default value	Modify
		1: Absolute position (home) (reserved) Bit1: Positioning cycle selection 0: Cyclic positioning by terminals 1: Automatic cyclic positioning Bit2: Cycle mode 0: Continuous 1: Repetitive (supported by automatic cyclic positioning only) Bit3: P21.17 digital setting mode 0: Incremental 1: Position type (do not support continuous mode) Bit4: Home searching mode 0: Search for the home just once 1: Search for the home during each run Bit5: Home calibration mode 0: Calibrate in real time 1: Single calibration Bit6: Positioning completion signal selection 0: Valid during the time set by P21.25 (Hold time of positioning completion signal) 1: Always valid Bit7: Initial positioning selection (for cyclic positioning by terminals) 0: Invalid (do not rotate) 1: Valid Bit8: Positioning enable signal selection (for cyclic positioning by terminals only; positioning function is always enabled for automatic cyclic positioning) 0: Pulse signal 1: Level signal Bit9: Position source 0: P21.17 setting 1: PROFIBUS/CANopen setting Bit10: Whether to save the encoder pulse counting value 0: Do not save 1: Save Bit 11: Reserved		

Function code	Name	Description	Default value	Modify
		Bit12: Positioning curve selection (reserved) 0: Straight line 1: S curve		
P21.17	Position digital reference	Set digital positioning position; Actual position= $P21.17 \times P21.11 / P21.12$ 0–65535	0	○
P21.18	Positioning speed setup selection	0: Set by P21.19 1: Set by AI1 2: Set by AI2 3: Set by AI3 4: Set by high speed pulse HDIA 5: Set by high speed pulse HDIB	0	○
P21.19	Positioning speed digits	0–100.0% max. frequency	20.0%	○
P21.20	Acceleration time of positioning	Set the acceleration/deceleration time of positioning process.	3.00s	○
P21.21	Deceleration time of positioning	Acceleration time of positioning means the time needed for the VFD to accelerate from 0Hz to Max. output frequency (P00.03). Deceleration time of positioning means the time needed for the VFD to decelerate from Max. output frequency (P00.03) to 0hz. Setting range of P21.20: 0.01–300.00s Setting range of P21.21: 0.01–300.00s	3.00s	○
P21.22	Hold time of positioning arrival	Set the hold time of waiting when target positioning position is reached. Setting range: 0.000–60.000s	0.100s	○
P21.23	Home search speed	0.00–50.00Hz	2.00Hz	○
P21.24	Home position offset	0–65535	0	○
P21.25	Hold time of positioning completion signal	The hold time of positioning completion signal, this parameter is also valid for positioning completion signal of spindle orientation. Setting range: 0.000–60.000s	0.200s	○
P21.26	Pulse superposition value	0–65535	0	○

Function code	Name	Description	Default value	Modify
P21.27	Pulse superposition speed	0–6553.5	8.0	<input type="radio"/>
P21.28	Acceleration/deceleration time after disabling pulse	000.0–3000.0s	5.0s	<input type="radio"/>
P21.29	Speed feedforward filter time constant (pulse string speed mode)	It is the filter time constant detected by pulse string when the speed reference source is set to pulse string (P0.06=12 or P0.07=12). Setting range: 0–3200.0ms	10.0ms	<input type="radio"/>
P21.30	Numerator of the 2 nd command ratio	1–65535	1000	<input type="radio"/>
P21.31–P21.33	Reserved	0–65535	0	<input type="radio"/>

P22—Spindle positioning

Function code	Name	Description	Default value	Modify
P22.00	Spindle positioning mode selection	Bit0: Enable spindle positioning 0: Disable 1: Enable Bit1: Select spindle positioning reference point 0: Z pulse input 1: S2/S3/S4 terminal input Bit2: Search for reference point 0: Search the reference point only once 1: Search the reference point every time Bit3: Enable reference point calibration 0: Disable 1: Enable Bit4: Positioning mode selection 1 0: Set direction positioning 1: Near-by direction positioning Bit5: Positioning mode selection 2	0	<input type="radio"/>

Function code	Name	Description	Default value	Modify
		0: Forward positioning 1: Reverse positioning Bit6: Zeroing command selection 0: Electric level mode 1: Pulse mode Bit7: Reference point calibration mode 0: Calibrate at the first time 1: Calibrate in real time Bit8: Action selection after zeroing signal cancellation (electric level type) 0: Switch to speed mode 1: Position lock mode Bit9: Positioning completion signal selection 0: Electric level signal 1: Pulse signal Bit10: Z pulse signal source 0: Motor 1: Spindle Bit11–15: Reserved		
P22.01	Speed of spindle orientation	During spindle orientation, the speed of the position point of orientation will be searched, and then it will switch over to position control orientation. Setting range: 0.00–100.00Hz	10.00Hz	<input type="radio"/>
P22.02	Deceleration time of spindle orientation	Deceleration time of spindle orientation. Spindle orientation deceleration time means the time needed for the VFD to decelerate from Max. output frequency (P00.03) to 0Hz. Setting range: 0.0–100.0s	3.0s	<input type="radio"/>
P22.03	Spindle zeroing position 0	You can select the zeroing positions of four spindles by terminals (function code 46, 47). Setting range: 0–39999	0	<input type="radio"/>
P22.04	Spindle zeroing position 1	Setting range: 0–39999	0	<input type="radio"/>
P22.05	Spindle zeroing position 2	Setting range: 0–39999	0	<input type="radio"/>
P22.06	Spindle zeroing position 3	Setting range: 0–39999	0	<input type="radio"/>

Function code	Name	Description	Default value	Modify
P22.07	Spindle scale-division angle 1	You can select seven spindle scale-division values by terminals (function code 48, 49 and 50). Setting range: 0.00–359.99	15.00	○
P22.08	Spindle scale-division angle 2	Setting range: 0.00–359.99	30.00	○
P22.09	Spindle scale-division angle 3	Setting range: 0.00–359.99	45.00	○
P22.10	Spindle scale-division angle 4	Setting range: 0.00–359.99	60.00	○
P22.11	Spindle scale-division angle 5	Setting range: 0.00–359.99	90.00	○
P22.12	Spindle scale-division angle 6	Setting range: 0.00–359.99	120.00	○
P22.13	Spindle scale-division angle 7	Setting range: 0.00–359.99	180.00	○
P22.14	Spindle drive ratio	This function code sets the reduction ratio of the spindle and the mounting shaft of the encoder. Setting range: 0.000–30.000	1.000	○
P22.15	Zero-point communication setup of spindle	P22.15 sets spindle zero-point offset, if the selected spindle zero point is P22.03, the final spindle zero point will be the sum of P22.03 and P22.15. Setting range: 0–39999	0	○
P22.16	Reserved	0–65535	0	○
P22.17	Reserved	0–65535	0	○
P22.18	Rigid tapping selection	Ones: Enable/disable 0: Disable 1: Enable Tens: Analog port selection 0: Invalid 1: A11	0x00	◎

Function code	Name	Description	Default value	Modify
		2: AI2 3: AI3		
P22.19	Analog filter time of rigid tapping	0.0ms–1000.0ms	1.0ms	<input type="radio"/>
P22.20	Max. frequency of rigid tapping	0.00–400.00Hz	50.00Hz	<input type="radio"/>
P22.21	Corresponding frequency of analog zero drift of rigid tapping	0.00–10.00Hz	0.00Hz	<input type="radio"/>
P22.22	Pulse reference speed measuring method	0: Main control board 1: PG card 2: Hybrid method	0	<input type="radio"/>
P22.23	Reserved	0–65535	0	<input type="radio"/>
P22.24	Setting of clearing the encoder counting value	0–65535	0	<input type="radio"/>

P23—Vector control of motor 2

Function code	Name	Description	Default value	Modify
P23.00	Speed loop proportional gain 1	P23.00–P23.05 fit for vector control mode only. Below switch-over frequency 1 (P23.02), the speed loop PI parameters are P23.00 and P23.01. Above switch-over frequency 2 (P23.05), the speed loop PI parameters are P23.03 and P23.04; in between them, the PI parameters are obtained by linear variation between two groups of parameters, as shown in the figure below.	20.0	<input type="radio"/>
P23.01	Speed loop integral time 1		0.200s	<input type="radio"/>
P23.02	Switch over low point frequency		5.00Hz	<input type="radio"/>
P23.03	Speed loop proportional gain 2		20.0	<input type="radio"/>
P23.04	Speed loop integral time 2		0.200s	<input type="radio"/>
P23.05	Switch over high point frequency		10.00Hz	<input type="radio"/>

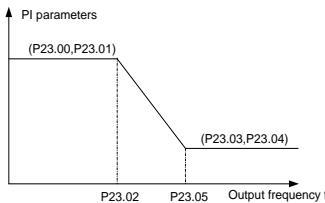

Function code	Name	Description	Default value	Modify
		<p>The speed loop dynamic response characteristics of vector control can be adjusted by setting the proportional coefficient and integral time of speed regulator. Increase proportional gain or decrease integral time can accelerate dynamic response of speed loop, however, if the proportional gain is too large or integral time is too small, system oscillation and large overshoot may occur; if proportional gain is too small, stable oscillation or speed offset may occur.</p> <p>Speed loop PI parameter is closely related to the system inertia, you should make adjustment according to different load characteristics based on the default PI parameter to fulfill different needs.</p> <p>Setting range of P23.00: 0.0–200.0 Setting range of P23.01: 0.000–10.000s Setting range of P23.02: 0.00Hz–P23.05 Setting range of P23.03: 0.0–200.0 Setting range of P23.04: 0.000–10.000s Setting range of P23.05: P23.02–P00.03 (Max. output frequency)</p>		
P23.06	Speed loop output filter	0–8 (corresponds to 0–2 ⁸ /10ms)	0	<input type="radio"/>
P23.07	Slip compensation coefficient of vector control (motoring)	Slip compensation coefficient is used to adjust the slip frequency of vector control to improve system speed control precision. You can effectively control the static error of speed by adjusting this parameter properly.	100%	<input type="radio"/>
P23.08	Slip compensation coefficient of vector control (generating)	Setting range: 50–200%	100%	<input type="radio"/>
P23.09	Current loop proportional coefficient P	<p>Note:</p> <p>1. These two parameters are used to adjust PI parameters of current loop; it affects dynamic</p>	1000	<input type="radio"/>

Function code	Name	Description	Default value	Modify
P23.10	Current loop integral coefficient I	response speed and control precision of the system directly. The default value needs no adjustment under common conditions; 2. Fit for SVC mode 0 (<u>P00.00</u> =0), SVC mode 1 (<u>P00.00</u> =1) and VC mode (<u>P00.00</u> =3); Setting range: 0–65535	1000	<input type="radio"/>
P23.11	Speed loop differential gain	0.00–10.00s	0.00s	<input type="radio"/>
P23.12	Proportional coefficient of high-frequency current loop	Under VC mode (<u>P00.00</u> =3), below current loop high-frequency switch-over threshold (P23.14), current loop PI parameters are P23.09 and P23.10; above current loop high-frequency switch-over threshold, current loop PI parameters are P23.12 and P23.13. Setting range of P23.12: 0–65535	1000	<input type="radio"/>
P23.13	Integral coefficient of high-frequency current loop	Setting range of P23.13: 0–65535	1000	<input type="radio"/>
P23.14	High-frequency switch-over threshold of current loop	Setting range of P23.14: 0.0–100.0% (relative to max. frequency)	100.0%	<input type="radio"/>
P23.15– P23.19	Reserved	0–65535	0	<input checked="" type="radio"/>

P24—Encoder of motor 2

Function code	Name	Description	Default value	Modify
P24.00	Encoder type display	0: Incremental encoder 1: Resolver-type encoder 2: Sin/Cos encoder 3: Endat absolute encoder	0	<input checked="" type="radio"/>
P24.01	Encoder pulse number	Number of pulses generated when the encoder revolves for one circle. Setting range: 0–60000	1024	<input type="radio"/>
P24.02	Encoder direction	Ones: AB direction 0: Forward 1: Reverse Tens: Z pulse direction (reserved)	0x000	<input type="radio"/>

Function code	Name	Description	Default value	Modify
		0: Forward 1: Reverse Hundreds: CD/UVW pole signal direction 0: Forward 1: Reverse		
P24.03	Detection time of encoder offline fault	0.0–10.0s	2.0s	○
P24.04	Detection time of encoder reversal fault	0.0–100.0s	0.8s	○
P24.05	Filter times of encoder detection	Setting range: 0x00–0x99 Ones: Low-speed filter times, corresponds to $2^{(0-9)} \times 125\mu\text{s}$. Tens: High-speed filter times; corresponds to $2^{(0-9)} \times 125\mu\text{s}$.	0x33	○
P24.06	Speed ratio between encoder mounting shaft and motor	You need to set this parameter when the encoder is not installed on the motor shaft and the drive ratio is not 1. Setting range: 0.001–65.535	1.000	○
P24.07	Control parameters of synchronous motor	Bit0: Enable Z pulse calibration Bit1: Enable encoder angle calibration Bit2: Enable SVC speed measurement Bit3: Select resolver speed measurement mode Bit4: Z pulse capture mode Bit5: Do not detect encoder initial angle in v/f control Bit6: Enable CD signal calibration Bit7: Disable sin/cos sub-division speed measurement Bit8: Do not detect encoder fault during autotuning Bit9: Enable Z pulse detection optimization Bit10: Enable initial Z pulse calibration optimization Bit12: Clear Z pulse arrival signal after stop	0x3	○
P24.08	Enable Z pulse offline detection	0x00–0x11 Ones: Z pulse Reserved	0x10	○

Function code	Name	Description	Default value	Modify
		Tens: UVW pulse 0: Do not detect 1: Enable		
P24.09	Initial angle of Z pulse	Relative electric angle of encoder Z pulse and motor pole position. Setting range: 0.00–359.99	0.00	○
P24.10	Initial angle of the pole	Relative electric angle of encoder position and motor pole position. Setting range: 0.00–359.99	0.00	○
P24.11	Autotuning of initial angle of pole	0–3 1: Rotary autotuning (DC brake) 2: Static autotuning (suitable for resolver-type encoder, sin/cos with CD signal feedback) 3: Rotary autotuning (initial angle identification)	0	◎
P24.12	Speed measurement optimization selection	0: No optimization 1: Optimization mode 1 2: Optimization mode 2	1	◎
P24.13	CD signal zero offset gain	0–65535	0	○
P24.14	Encoder type selection	Ones: Incremental encoder 0: without UVW 1: with UVW Tens: Sin/Cos encoder 0: without CD signal 1: with CD signal	0x00	◎
P24.15	Speed measurement mode	0: PG card 1: local; realized by HDIA and HDIB; supports incremental 24V encoder only	0	◎
P24.16	Frequency-division coefficient	0–255 When this parameter is set to 0 or 1, frequency division of 1:1 is implemented.	0	○
P24.17	Pulse filer processing	0x0000–0xFFFF Bit0: Enable/disable encoder input filter 0: No filter 1: Filter Bit1: Encoder signal filter mode	0x0033	○

Function code	Name	Description	Default value	Modify
		0: Self-adaptive filter 1: Use P24.18 filter parameters Bit2: Enable/disable encoder frequency-division output filter 0: No filter 1: Filter Bit3: Reserved Bit4: Enable/disable pulse reference filter 0: No filter 1: Filter Bit5: Pulse reference filter mode 0: Self-adaptive filter 1: Use P24.19 filter parameters Bit6: Frequency-divided output source setting 0: Encoder signals 1: Pulse reference signals Bits7–15: Reserved		
P24.18	Encoder pulse filter width	0–63 The filtering time is $P24.18 \times 0.25 \mu s$. The value 0 or 1 indicates $0.25 \mu s$.	2	<input type="radio"/>
P24.19	Pulse reference filter width	0–63 The filtering time is $P24.19 \times 0.25 \mu s$. The value 0 or 1 indicates $0.25 \mu s$.	2	<input type="radio"/>
P24.20	Pulse number of pulse reference	0–65535	1024	<input checked="" type="radio"/>
P24.21	Enable angle compensation of synchronous motor	0–1	0	<input type="radio"/>
P24.22	Switch-over frequency threshold of speed measurement mode	0–630.00Hz	1.00Hz	<input type="radio"/>
P24.23	Synchronous motor angle	-200.0–200.0%	100.0%	<input type="radio"/>

Function code	Name	Description	Default value	Modify
	compensation coefficient			
P24.24	Reserved	0-65535	0	<input type="radio"/>

P25—Extension I/O card input functions

Function code	Name	Description	Default value	Modify
P25.00	HDI3 input type selection	0: HDI3 is high-speed pulse input 1: HDI3 is digital input	0	<input checked="" type="radio"/>
P25.01	S5 terminal function	The same with P05 group	0	<input checked="" type="radio"/>
P25.02	S6 terminal function		0	<input checked="" type="radio"/>
P25.03	S7 terminal function		0	<input checked="" type="radio"/>
P25.04	S8 terminal function		0	<input checked="" type="radio"/>
P25.05	S9 terminal function		0	<input checked="" type="radio"/>
P25.06	S10 terminal function		0	<input checked="" type="radio"/>
P25.07	HDI3 terminal function		0	<input checked="" type="radio"/>
P25.08	Input terminal polarity of extension card		0x00-0x7F	0x00
P25.09	Virtual terminal setup of extension card	0x000-0x7F (0: disable, 1: enable) BIT0: S5 virtual terminal BIT1: S6 virtual terminal BIT2: S7 virtual terminal BIT3: S8 virtual terminal BIT4: S9 virtual terminal BIT5: S10 virtual terminal BIT6: HDI3 virtual terminal	0x00	<input checked="" type="radio"/>
P25.10	HDI3 terminal switch-on delay	These function codes define corresponding delay of the programmable input terminals during level	0.000s	<input type="radio"/>

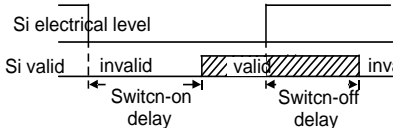
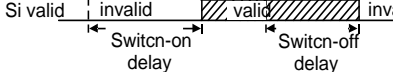
Function code	Name	Description	Default value	Modify
P25.11	HDI3 terminal switch-off delay	variation from switch-on to switch-off . 	0.000s	<input type="radio"/>
P25.12	S5 terminal switch-on delay		0.000s	<input type="radio"/>
P25.13	S5 switch-off delay	Setting range: 0.000–50.000s	0.000s	<input type="radio"/>
P25.14	S6 terminal switch-on delay		0.000s	<input type="radio"/>
P25.15	S6 switch-off delay		0.000s	<input type="radio"/>
P25.16	S7 terminal switch-on delay		0.000s	<input type="radio"/>
P25.17	S7 switch-off delay		0.000s	<input type="radio"/>
P25.18	S8 terminal switch-on delay		0.000s	<input type="radio"/>
P25.19	S8 switch-off delay		0.000s	<input type="radio"/>
P25.20	S9 terminal switch-on delay		0.000s	<input type="radio"/>
P25.21	S9 switch-off delay		0.000s	<input type="radio"/>
P25.22	S10 terminal switch-on delay		0.000s	<input type="radio"/>
P25.23	S10 switch-off delay		0.000s	<input type="radio"/>
P25.24	Lower limit value of AI3	These function codes define the relation between analog input voltage and corresponding set value of analog input. When the analog input voltage exceeds the range of max./min. input, the max. input or min. input will be adopted during calculation. When analog input is current input, 0–20mA current corresponds to 0–10V voltage. In different application cases, 100% of the analog setting corresponds to different nominal values.	0.00V	<input type="radio"/>
P25.25	Corresponding setting of lower limit of AI3		0.0%	<input type="radio"/>
P25.26	Upper limit value of AI3		10.00V	<input type="radio"/>
P25.27	Corresponding setting of upper limit of AI3		100.0%	<input type="radio"/>

Function code	Name	Description	Default value	Modify
P25.28	Input filter time of AI3	<p>The figure below illustrates several settings.</p>	0.030s	<input type="radio"/>
P25.29	Lower limit value of AI4		0.00V	<input type="radio"/>
P25.30	Corresponding setting of lower limit of AI4		0.0%	<input type="radio"/>
P25.31	Upper limit value of AI4		10.00V	<input type="radio"/>
P25.32	Corresponding setting of upper limit of AI4		100.0%	<input type="radio"/>
P25.33	Input filter time of AI4	<p>Input filter time: Adjust the sensitivity of analog input, increase this value properly can enhance the anti-interference capacity of analog variables; however, it will also degrade the sensitivity of analog input.</p> <p>Note: AI3 and AI4 can support 0–10V/0–20mA input, when AI3 and AI4 select 0–20mA input, the corresponding voltage of 20mA is 10V;</p> <p>Setting range of P25.24: 0.00V–P25.26 Setting range of P25.25: -300.0%–300.0% Setting range of P25.26: P25.24–10.00V Setting range of P25.27: -300.0%–300.0% Setting range of P25.28: 0.000s–10.000s Setting range of P25.29: 0.00V–P25.31 Setting range of P25.30: -300.0%–300.0% Setting range of P25.31: P25.29–10.00V Setting range of P25.32: -300.0%–300.0% Setting range of P25.33: 0.000s–10.000s</p>	0.030s	<input type="radio"/>
P25.34	HDI3 high-speed pulse input function	0: Set input via frequency 1: Count	0	<input checked="" type="radio"/>
P25.35	Lower limit frequency of HDI3	0.000 kHz – P25.37	0.000 kHz	<input type="radio"/>
P25.36	Corresponding setting of lower limit frequency of	-300.0%–300.0%	0.0%	<input type="radio"/>

Function code	Name	Description	Default value	Modify
	HDI3			
P25.37	Upper limit frequency of HDI3	P25.35–50.000kHz	50.000 kHz	<input type="radio"/>
P25.38	Corresponding setting of upper limit frequency of HDI3	-300.0%–300.0%	100.0%	<input type="radio"/>
P25.39	HDI3 frequency input filter time	0.000s–10.000s	0.030s	<input type="radio"/>
P25.40	AI3 input signal type	Range: 0–1 0: Voltage type 1: Current type	0	<input type="radio"/>
P25.41	AI4 input signal type	Range: 0–1 0: Voltage type 1: Current type	0	<input type="radio"/>
P25.42–P25.45	Reserved	0–65535	0	<input type="radio"/>

P26—Output functions of extension I/O card

Function code	Name	Description	Default value	Modify
P26.00	HDO2 output type	0: Open collector high-speed pulse output 1: Open collector output	0	<input checked="" type="radio"/>
P26.01	HDO2 output selection	The same with P06.01	0	<input type="radio"/>
P26.02	Y2 output selection		0	<input type="radio"/>
P26.03	Y3 output selection		0	<input type="radio"/>
P26.04	Relay RO3 output selection		0	<input type="radio"/>
P26.05	Relay RO4 output selection		0	<input type="radio"/>
P26.06	Relay RO5 output selection		0	<input type="radio"/>

Function code	Name	Description	Default value	Modify	
P26.07	Relay RO6 output selection		0	<input type="radio"/>	
P26.08	Relay RO7 output selection		0	<input type="radio"/>	
P26.09	Relay RO8 output selection		0	<input type="radio"/>	
P26.10	Relay RO9 output selection		0	<input type="radio"/>	
P26.11	Relay RO10 output selection		0	<input type="radio"/>	
P26.12	Output terminal polarity of extension card		0x0000–0x7FF RO10, RO9...RO3, HDO2, Y3, Y2 in sequence	0x000	<input type="radio"/>
P26.13	HDO2 switch-on delay	<p>This function code defines the corresponding delay of the level variation from switch-on to switch-off.</p> <p>Y electric level</p> <p>Y valid Invalid Valid Invalid</p> <p>← Switch on delay → ← Switch off delay →</p>	0.000s	<input type="radio"/>	
P26.14	HDO2 switch-off delay		0.000s	<input type="radio"/>	
P26.15	Y2 switch-on delay		0.000s	<input type="radio"/>	
P26.16	Y2 switch-off delay		0.000s	<input type="radio"/>	
P26.17	Y3 switch-on delay		0.000s	<input type="radio"/>	
P26.18	Y3 switch-off delay		0.000s	<input type="radio"/>	
P26.19	Relay RO3 switch-on delay		<p>Setting range: 0.000–50.000s</p> <p>Note: P26.13 and P26.14 are valid only when P26.00 is set to 1.</p>	0.000s	<input type="radio"/>
P26.20	Relay RO3 switch-off delay			0.000s	<input type="radio"/>
P26.21	Relay RO4 switch-on delay			0.000s	<input type="radio"/>
P26.22	Relay RO4 switch-off delay			0.000s	<input type="radio"/>
P26.23	Relay RO5 switch-on delay			0.000s	<input type="radio"/>
P26.24	Relay RO5 switch-off delay			0.000s	<input type="radio"/>

Function code	Name	Description	Default value	Modify
P26.25	Relay RO6 switch-on delay		0.000s	<input type="radio"/>
P26.26	Relay RO6 switch-off delay		0.000s	<input type="radio"/>
P26.27	Relay RO7 switch-on delay		0.000s	<input type="radio"/>
P26.28	Relay RO7 switch-off delay		0.000s	<input type="radio"/>
P26.29	Relay RO8 switch-on delay		0.000s	<input type="radio"/>
P26.30	Relay RO8 switch-off delay		0.000s	<input type="radio"/>
P26.31	Relay RO9 switch-on delay		0.000s	<input type="radio"/>
P26.32	Relay RO9 switch-off delay		0.000s	<input type="radio"/>
P26.33	Relay RO10 switch-on delay		0.000s	<input type="radio"/>
P26.34	Relay RO10 switch-off delay		0.000s	<input type="radio"/>
P26.35	AO2 output selection		0	<input type="radio"/>
P26.36	AO3 output selection	The same with P06.14	0	<input type="radio"/>
P26.37	Reserved		0	<input type="radio"/>
P26.38	Lower limit of AO2 output		0.0%	<input type="radio"/>
P26.39	Corresponding AO2 output of lower limit	Above function codes define the relation between output value and analog output. When the output value exceeds the set max./min. output range, the upper/low limit of output will be adopted during calculation.	0.00V	<input type="radio"/>
P26.40	Upper limit of AO2 output		100.0%	<input type="radio"/>
P26.41	Corresponding AO2 output of upper limit	When analog output is current output, 1mA corresponds to 0.5V voltage. In different applications, 100% of output value corresponds to different analog outputs.	10.00V	<input type="radio"/>
P26.42	AO2 output filter time		0.000s	<input type="radio"/>

Function code	Name	Description	Default value	Modify	
P26.43	Lower limit of AO3 output		0.0%	<input type="radio"/>	
P26.44	Corresponding AO3 output of lower limit		0.00V	<input type="radio"/>	
P26.45	Upper limit of AO3 output		100.0%	<input type="radio"/>	
P26.46	Corresponding AO3 output of upper limit		10.00V	<input type="radio"/>	
P26.47	AO3 output filter time		Setting range of P26.38: -300.0%–P26.40	0.000s	<input type="radio"/>
			Setting range of P26.39: 0.00V–10.00V		
P26.48–P26.52	Reserved	0–65535	0	<input type="radio"/>	

P28—Master/slave control functions

Function code	Name	Description	Default value	Modify
P28.00	Master/slave mode selection	0: The master/slave control is invalid 1: This machine is a master 2: This machine is a slave	0	<input checked="" type="radio"/>
P28.01	Master/slave communication data selection	0: CAN 1: Reserved	0	<input checked="" type="radio"/>
P28.02	Master/slave control mode	Ones: Master/slave running mode selection 0: Master/slave mode 0 (The master and slave adopt speed control and maintains the power balance by droop control) 1: Master/slave mode 1 (The master and slave must be in the same type of vector control mode. The master is speed control, and the slave will be forced to be in the torque control mode.	0x001	<input checked="" type="radio"/>

Function code	Name	Description	Default value	Modify
		2: Master/slave mode 2 Start in the slave first speed mode (master/slave mode 0) and then switch to torque mode at a certain frequency point (master/slave mode 1) Tens: Slave start command source selection 0: Follow the master to start 1: Determined by P00.01 Hundreds: Slave transmitting/master receiving data enable 0: Enable 1: Disable		
P28.03	Slave speed gain	0.0–500.0%	100.0%	<input type="radio"/>
P28.04	Slave torque gain	0.0–500.0%	100.0%	<input type="radio"/>
P28.05	Master/slave mode 2 speed mode / torque mode switching frequency point	0.00–10.00Hz	5.00Hz	<input type="radio"/>
P28.06	Number of slaves	0–15	1	<input checked="" type="radio"/>
P28.07–P28.29	Reserved	0–65535	0	<input type="radio"/>

P90—Customized function group 1

Function code	Name	Description	Default value	Modify
P90.00–P90.39	Reserved	0–65535	0	<input type="radio"/>

P91—Customized function group 2

Function code	Name	Description	Default value	Modify
P91.00–P91.39	Reserved	0–65535	0	<input type="radio"/>

P92—Customized function group 3

Function code	Name	Description	Default value	Modify
P92.00– P92.39	Reserved	0–65535	0	<input type="radio"/>

P93—Customized function group 4

Function code	Name	Description	Default value	Modify
P93.00– P93.39	Reserved	0–65535	0	<input type="radio"/>

7 Troubleshooting

7.1 What this chapter contains

The chapter tells users how to reset faults and check faults history. A complete list of alarms and fault information as well as possible causes and corrective measures are presented in this chapter.

	◇ Only well-trained and qualified professionals are allowed to carry out the work described in this chapter. Operations should be carried out according to the instructions presented in 1 "Safety precautions".
---	--

7.2 Indications of alarms and faults

The fault is indicated by indicators (refer to the "Keypad operation process"). When **TRIP** indicator is on, the alarm or fault code displayed in the keypad indicates the VFD is in exception state. This chapter covers most of the alarms and faults, and their possible causes and corrective measures, if users cannot figure out the alarm or fault causes, contact local INVT office.

7.3 Fault reset

Users can reset the VFD via **STOP/RS1** key on the keypad, digital inputs, or by cutting off the VFD power. After faults are removed, the motor can be start again.

7.4 Fault history

P07.27–P07.32 record the six latest fault types; P07.33–P07.40, P07.41–P07.48, and P07.49–P07.56 record the running data of the VFD when the latest three faults occurred.

7.5 VFD faults and solutions

When fault occurred, process the fault as shown below.

1. When VFD fault occurred, confirm whether keypad display is improper? If yes, contact INVT;
2. If keypad works properly, check the function codes in P07 group to confirm the corresponding fault record parameters, and determine the real state when current fault occurred through parameters;
3. Check the table below to see whether corresponding exception states exist based on the corresponding corrective measures;
4. Rule out the faults or ask for help from professionals;
5. After confirming faults are removed, reset the fault and start running.

7.5.1 Details of faults and solutions

Fault code	Fault type	Possible cause	Corrective measures
O _U t1	Inverter unit Phase-U protection	Acceleration is too fast; IGBT module is damaged;	Increase acceleration time; Replace the power unit;
O _U t2	Inverter unit Phase-V protection	Misacts caused by interference; drive wires are	Check drive wires; Check whether there is strong

Fault code	Fault type	Possible cause	Corrective measures
OUt3	Inverter unit Phase-W protection	poorly connected ; To-ground short circuit occurs	interference surrounds the peripheral equipment
OV1	Over-voltage during acceleration	Deceleration time is too short;	Check input power;
OV2	Over-voltage during deceleration	Exception occurred to input voltage;	Check whether load deceleration time is too short;
OV3	Over-voltage during constant speed running	Large energy feedback; Lack of brake units; Dynamic brake is not enabled, and the deceleration time is too short.	or the motor starts during rotating; Install dynamic brake units; Check the setup of related function codes
OC1	Over-current during acceleration	Acceleration is too fast; Grid voltage is too low; VFD power is too small; Load transient or exception occurred; To-ground short circuit or output phase loss occur; Strong external interference sources; Overvoltage stall protection is not enabled	Increase acceleration /deceleration time;
OC2	Over-current during deceleration		Check input power; Select the VFD with larger power;
OC3	Over-current during constant speed running		Check if the load is short circuited (to-ground short circuit or line-to-line short circuit) or the rotation is not smooth; Check the output wiring; Check if there is strong interference; Check the setup of related function codes.
UV	Bus undervoltage fault	Grid voltage is too low; Overvoltage stall protection is not enabled	Check grid input power; Check the setup of related function codes
OL1	Motor overload	Grid voltage is too low; Rated motor current is set improperly; Motor stall or load jumps violently	Check grid voltage; Reset rated motor current; Check the load and adjust torque boost
OL2	VFD overload	Acceleration is too fast; The motor in rotating is restarted;	Increase acceleration time; Avoid restart after stop; Check grid voltage;

Fault code	Fault type	Possible cause	Corrective measures
		Grid voltage is too low; Load is too large; Power is too small;	Select the VFD with larger power; Select proper motor
SPI	Phase loss on input side	Phase loss or violent fluctuation occurred to R, S and T input	Check the input power; Check installation wiring
SPO	Phase loss on output side	Phase loss occurred to U, V, W output (or the three phases of motor is asymmetrical)	Check the output wiring; Check the motor and cable
OH1	Overheat of rectifier module	Air duct is blocked or fan is damaged;	Ventilate the air duct or replace the fan; Lower the ambient temperature
OH2	Overheat of inverter module	Ambient temperature is too high; Long-time overload running	
EF	External fault	SI external fault input terminal acts	Check external device input
CE	485 communication fault	Baud rate is set improperly; Communication line fault; Communication address error; Communication suffers from strong interference	Set proper baud rate; Check the wiring of communication interfaces; Set proper communication address; Replace or change the wiring to enhance anti-interference capacity
ItE	Current detection fault	Poor contact of the connector of control board; Hall component is damaged; Exception occurred to amplification circuit	Check the connector and re-plug; Replace the hall component; Replace the main control board
tE	Motor autotuning fault	Motor capacity does not match with the VFD capacity, this fault may occur easily if the difference between them is exceeds five power classes; Motor parameter is set	Change the VFD model, or adopt V/F mode for control; Set proper motor type and nameplate parameters; Empty the motor load and carry out autotuning again; Check motor wiring and

Fault code	Fault type	Possible cause	Corrective measures
		improperly; The parameters gained from autotuning deviate sharply from the standard parameters; Autotuning timeout	parameter setup; Check whether upper limit frequency is larger than 2/3 of the rated frequency
EEP	EEPROM fault	R/W error occurred to the control parameters; EEPROM is damaged	Press STOP/RST to reset; Replace the main control board
PIDE	PID feedback offline fault	PID feedback offline; PID feedback source disappears;	Check PID feedback signal wires; Check PID feedback source
bCE	Brake unit fault	Brake circuit fault or brake tube is damaged; The resistance of external brake resistor is too small	Check the brake unit, replace with new brake tubes; Increase brake resistance
END	Running time is up	The actual running time of the VFD is larger than the set running time	Ask help from the supplier, adjust the set running time
OL3	Electronic overload fault	The VFD releases overload pre-alarm based on the set value	Check the load and overload pre-alarm threshold
PCE	Keypad communication fault	The keypad wire is poorly contacted or disconnected; The keypad wire is too long and suffers strong interference; Circuit fault occurred to the keypad or communication part of the main board	Check the keypad wires to confirm whether fault exists; Check the surroundings to rule out interference source; Replace the hardware and ask for maintenance service
UPE	Parameter upload error	The keypad wire is poorly contacted or disconnected; The keypad wire is too long and suffers strong interference; Circuit fault occurred to the keypad or communication part of the main board	Check the surroundings to rule out interference source; Replace the hardware and ask for maintenance service; Replace the hardware and ask for maintenance service

Fault code	Fault type	Possible cause	Corrective measures
DNE	Parameter download error	The keypad wire is poorly contacted or disconnected; The keypad wire is too long and suffers strong interference; Data storage error occurred to the keypad	Check the surroundings to rule out interference source; Replace the hardware and ask for maintenance service; Re-backup keypad data
ETH1	To-ground short circuit fault 1	VFD output is short connected to the ground; Current detection circuit is faulty; Actual motor power setup deviates sharply from the VFD power	Check whether motor wiring is proper; Replace the hall component; Replace the main control board; Reset the motor parameters properly
ETH2	To-ground short circuit fault 1	VFD output is short connected to ground; Current detection circuit is faulty; Actual motor power setup deviates sharply from the VFD power	Check whether motor wiring is proper; Replace the hall component; Replace the main control board; Reset the motor parameters properly
dEu	Speed deviation fault	Load is too heavy, or stall occurred	Check the load to ensure it is proper, increase the detection time; Check whether control parameters are set properly
STo	Maladjustment fault	Control parameters of synchronous motor is set improperly; The parameter gained from autotuning is inaccurate; The VFD is not connected to motor	Check the load to ensure it is proper, Check whether load is proper; Check whether control parameters are set correctly; Increase maladjustment detection time
LL	Electronic underload fault	The VFD performs underload pre-alarm based on the set value	Check the load and overload pre-alarm threshold

Fault code	Fault type	Possible cause	Corrective measures
ENC1O	Encoder offline fault	Encoder line sequence is wrong, or signal wires are poorly connected	Check the encoder wiring
ENC1D	Encoder reversal fault	The encoder speed signal is contrary to the motor running direction	Reset encoder direction
ENC1Z	Encoder Z pulse offline fault	Z signal wires are disconnected	Check the wiring of Z signal
OT	Motor over-temperature fault	Motor over-temperature input terminal is valid; Exception occurred to temperature detection Exception occurred to resistor; Long-time overload running or exception occurred	Check the wiring of motor over-temperature input terminal (terminal function 57); Check whether temperature sensor is proper; Check the motor and perform maintenance on the motor
STO	Safe torque off	Safe torque off function is enabled by external forces	/
STL1	Exception occurred to safe circuit of channel H1	The wiring of STO is improper; Fault occurred to external switch of STO; Hardware fault occurred to safety circuit of channel H1	Check whether terminal wiring of STO is proper and firm enough; Check whether external switch of STO can work properly; Replace the control board
STL2	Exception occurred to channel H2 safe circuit	The wiring of STO is improper; Fault occurred to external switch of STO; Hardware fault occurred to safety circuit of channel H2	Check whether terminal wiring of STO is proper and firm enough; Check whether external switch of STO can work properly; Replace the control board
STL3	Exception occurred to channel H1 and channel H2	Hardware fault occurred to STO circuit	Replace the control board
CrCE	Safety code FLASH CRC check fault	Control board is faulty	Replace the control board
E-Err	Repetitive extension card type	The two inserted extension cards are of the same type	Users should not insert two cards with the same type;

Fault code	Fault type	Possible cause	Corrective measures
			check the type of extension card, and remove one card after power down
ENCUV	Encoder UVW loss fault	No electric level variation occurred to UVW signal	Check the wiring of UVW; Encoder is damaged
F1-Er	Failed to identify the extension card in card slot 1	There is data transmission in interfaces of card slot 1, however, it cannot read the card type	Confirm whether the extension card inserted can be supported; Stabilize the extension card interfaces after power down, and confirm whether fault still occurs at next power-on; Check whether the insertion port is damaged, if yes, replace the insertion port after power down
F2-Er	Failed to identify the extension card in card slot 2	There is data transmission in interfaces of card slot 2, however, it cannot read the card type	Confirm whether the extension card inserted can be supported; Stabilize the extension card interfaces after power down, and confirm whether fault still occurs at next power-on; Check whether the insertion port is damaged, if yes, replace the insertion port after power down
F3-Er	Failed to identify the the extension card in card slot 3	There is data transmission in interfaces of card slot 3, however, it cannot read the card type	Confirm whether the extension card inserted can be supported; Stabilize the extension card interfaces after power down, and confirm whether fault still occurs at next power-on; Check whether the insertion port is damaged, if yes, replace the insertion port after power down
C1-Er	Communication timeout occurred to the extension card in	There is no data transmission in interfaces of card slot 1	Confirm whether the extension card inserted can be supported; Stabilize the extension card

Fault code	Fault type	Possible cause	Corrective measures
	card slot 1		interfaces after power down, and confirm whether fault still occurs at next power-on; Check whether the insertion port is damaged, if yes, replace the insertion port after power down
C2-Er	Communication timeout occurred to the extension card in card slot 2	There is no data transmission in interfaces of card slot 2	Confirm whether the extension card inserted can be supported; Stabilize the extension card interfaces after power down, and confirm whether fault still occurs at next power-on; Check whether the insertion port is damaged, if yes, replace the insertion port after power down
C3-Er	Communication timeout occurred to the extension card in card slot 3	There is no data transmission in interfaces of card slot 3	Confirm whether the extension card inserted can be supported; Stabilize the extension card interfaces after power down, and confirm whether fault still occurs at next power-on; Check whether the insertion port is damaged, if yes, replace the insertion port after power down
E-DP	PROFIBUS card communication timeout fault	There is no data transmission between the communication card and the host computer (or PLC)	Check whether the communication card wiring is loose or dropped
E-NET	Ethernet card communication timeout fault	There is no data transmission between the communication card and the host computer	Check whether the communication card wiring is loose or dropped
E-CAN	CANopen card communication timeout fault	There is no data transmission between the communication card and the host computer (or PLC)	Check whether the communication card wiring is loose or dropped

Fault code	Fault type	Possible cause	Corrective measures
E-PN	PROFINET card communication timeout fault	There is no data transmission between the communication card and the host computer (or PLC)	Check whether the communication card wiring is loose or dropped
E-CAT	EtherCAT card communication timeout fault	There is no data transmission between the communication card and the host computer (or PLC)	Check whether the communication card wiring is loose or dropped
E-BAC	BACNet card communication timeout fault	There is no data transmission between the communication card and the host computer (or PLC)	Check whether the communication card wiring is loose or dropped
E-DEV	DeviceNet card communication timeout fault	There is no data transmission between the communication card and the host computer (or PLC)	Check whether the communication card wiring is loose or dropped
ESCAN	Can master/slave communication card communication timeout fault	There is no data transmission between the CAN master and slave communication cards	Check whether the communication card wiring is loose or dropped
S-Err	Master-slave synchronous CAN slave fault	Fault occurred to one of the CAN slave VFDs	Detect the CAN slave VFD and analyze the corresponding fault cause of the VFD

7.5.2 Other state

Displayed code	State type	Possible cause	Solution
PoFF	System power failure	The system is powered off or the bus voltage is too low.	Check the grid conditions.

7.6 Analysis on common faults

7.6.1 Motor fails to work

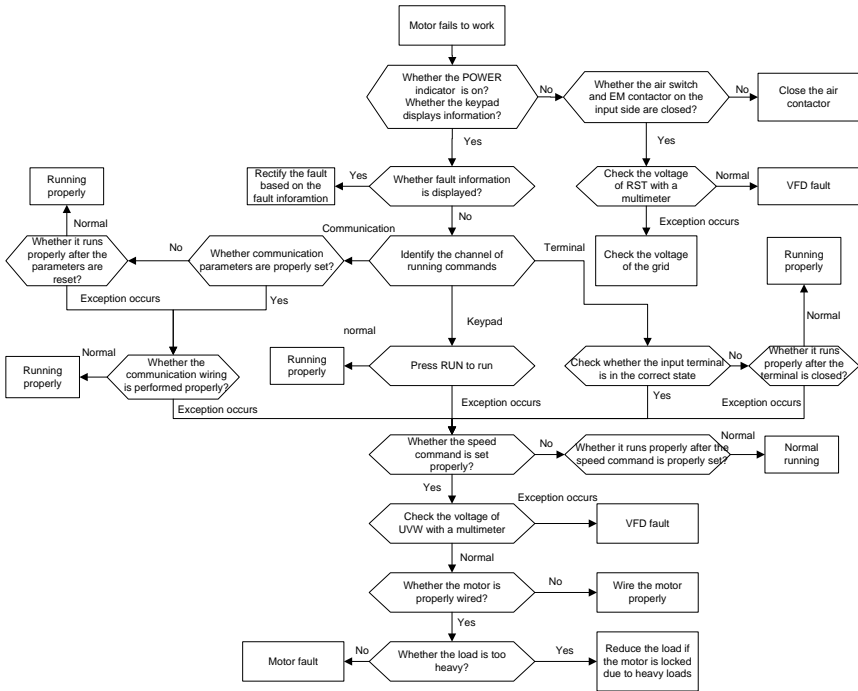

7.6.2 Motor vibrates

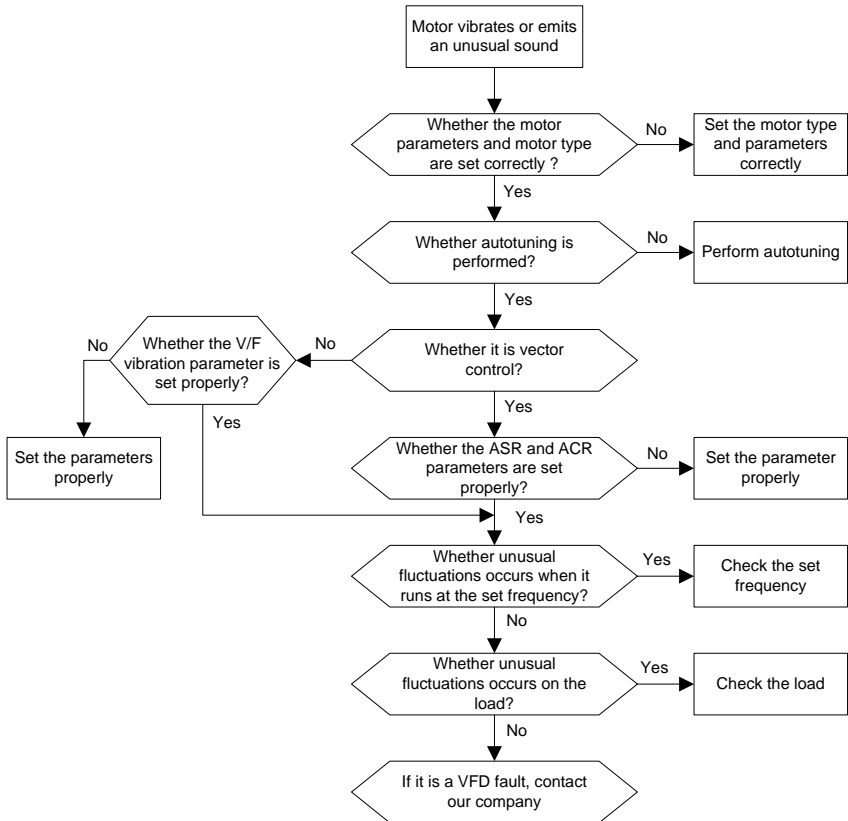

7.6.3 Overvoltage

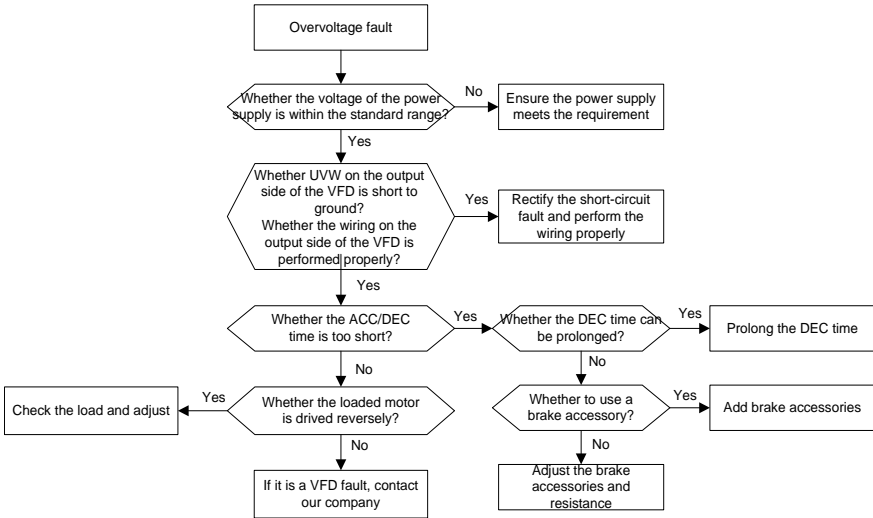

7.6.4 Undervoltage

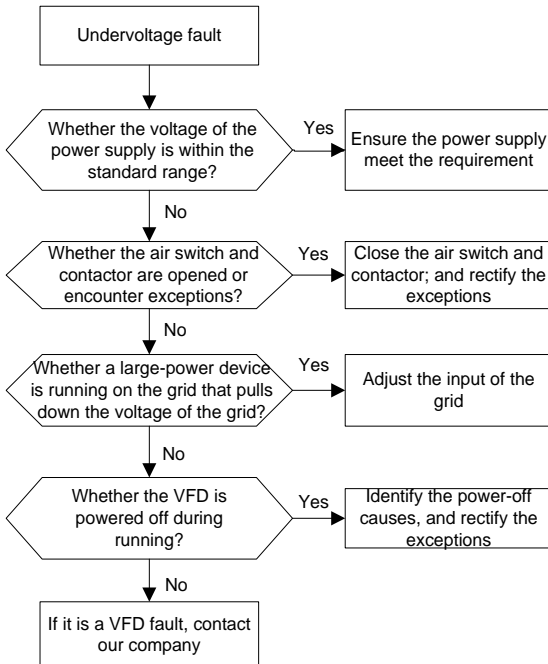

7.6.5 Unusual heating of motor

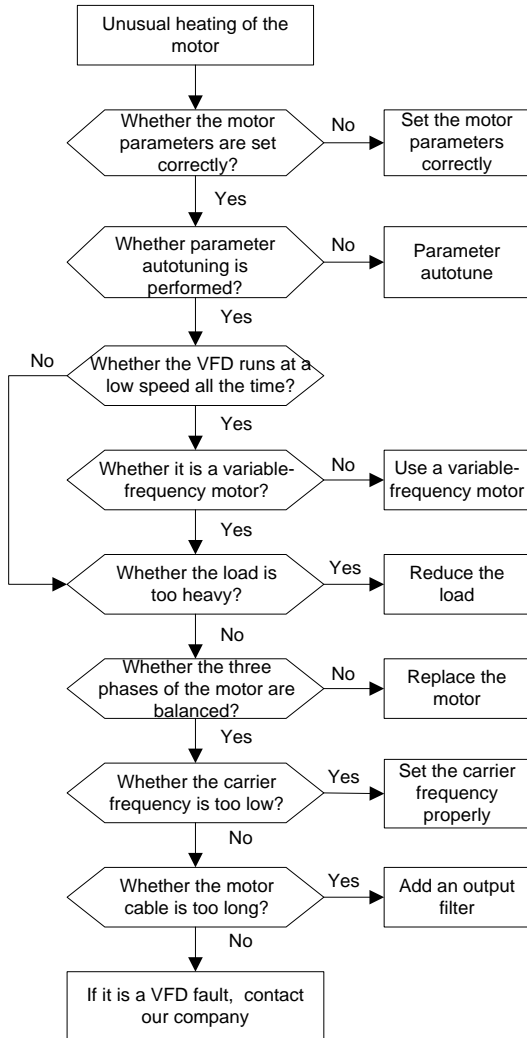

7.6.6 VFD overheating

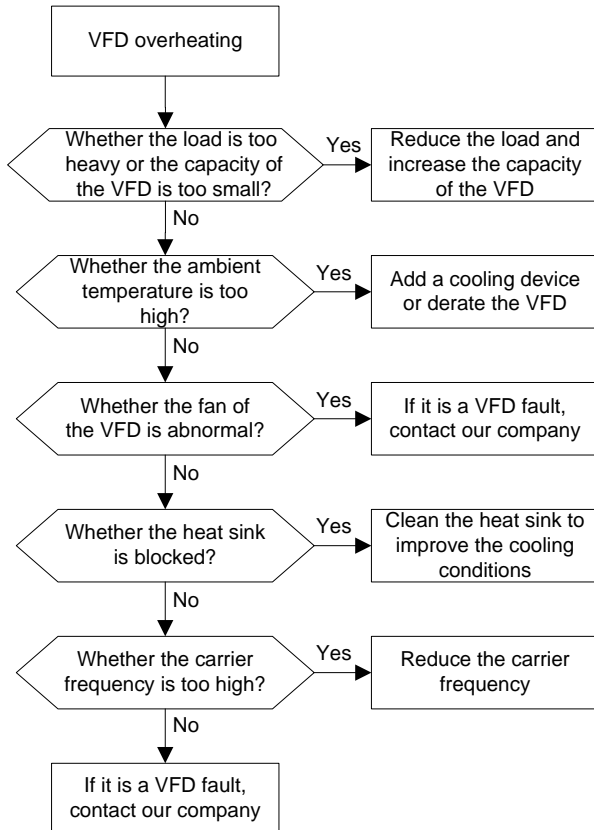

7.6.7 Motor stalls during ACC

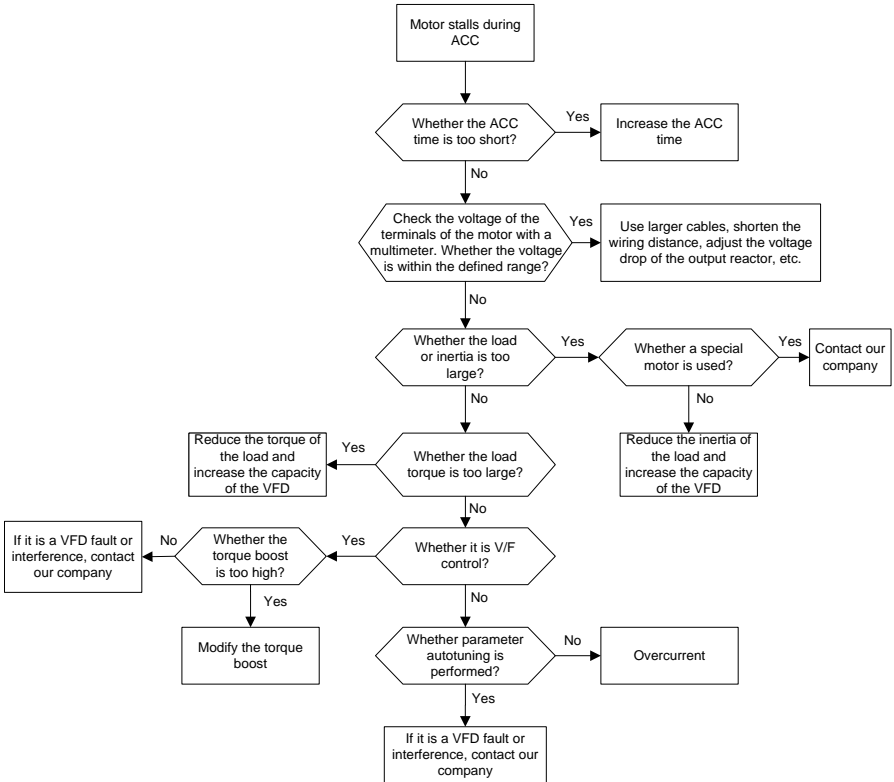

7.6.8 Overcurrent

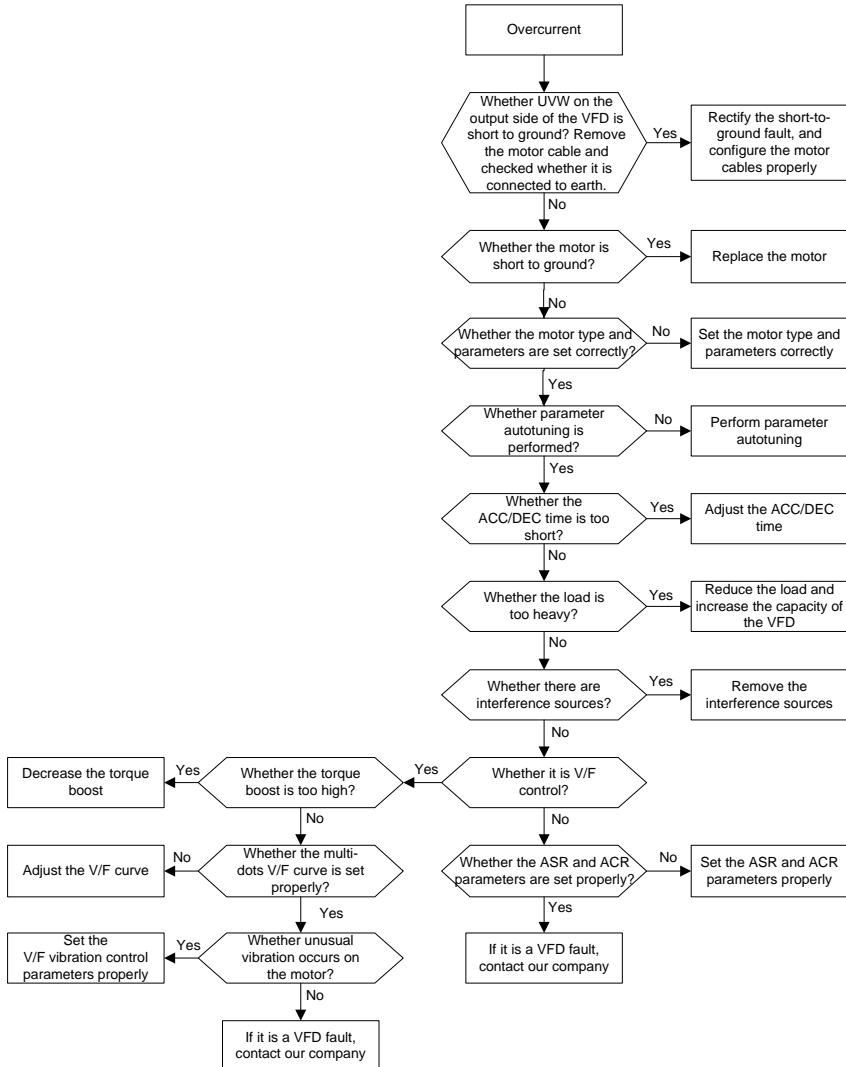

7.7 Countermeasures on common interference

7.7.1 Interference on meter switches and sensors

Interference phenomenon:

Pressure, temperature, displacement, and other signals of a sensor are collected and displayed by a human-machine interaction device. The values are incorrectly displayed as follows after the VFD is started:

1. The upper or lower limit is wrongly displayed, for example, 999 or -999.
2. The display of values jumps (usually occurring on pressure transmitters).
3. The display of values is stable, but there is a large deviation, for example, the temperature is dozens of degrees higher than the common temperature (usually occurring on thermocouples).
4. A signal collected by a sensor is not displayed but functions as a drive system running feedback signal. For example, a VFD is expected to decelerate when the upper pressure limit of the compressor is reached, but in actual running, it starts to decelerate before the upper pressure limit is reached.
5. After a VFD is started, the display of all kinds of meters (such as frequency meter and current meter) that are connected to the analog output (AO) terminal of the VFD is severely affected, displaying the values incorrectly.
6. Proximity switches are used in the system. After a VFD is started, the indicator of a proximity switch flickers, and the output level flips.

Solution:

1. Check and ensure that the feedback cable of the sensor is 20 cm or farther away from the motor cable.
2. Check and ensure that the ground wire of the motor is connected to the PE terminal of the VFD (if the ground wire of the motor has been connected to the ground block, you need to use a multimeter to measure and ensure that the resistance between the ground block and PE terminal is lower than 1.5 Ω).
3. Try to add a safety capacitor of 0.1 μF to the signal end of the feedback signal terminal of the sensor.
4. Try to add a safety capacitor of 0.1 μF to the power end of the sensor meter (pay attention to the voltage of the power supply and the voltage endurance of the capacitor).
5. For interference on meters connected to the AO terminal of a VFD, if AO uses current signals of 0 to 20 mA, add a capacitor of 0.47 μF between the AO and GND terminals; and if AO uses voltage signals of 0 to 10 V, add a capacitor of 0.1 μF between the AO and GND terminals.

Note:

1. When a decoupling capacitor is required, add it to the terminal of the device connected to the sensor. For example, if a thermocouple is to transmit signals of 0 to 20 mA to a temperature meter,

the capacitor needs to be added on the terminal of the temperature meter.; if an electronic ruler is to transmit signals of 0 to 30 V to a PLC signal terminal, the capacitor needs to be added on the terminal of the PLC.

2. If a large number of meters or sensors are disturbed. It is recommended that you configure an external C2 filter on the input power end of the VFD. For models of filters, see section D.7 "Filters".

7.7.2 Interference on communication

Interference phenomenon

The interference described in this section on 485 communication mainly includes communication delay, out of sync, occasional power-off, or complete power-off that occurs after a VFD is started.

If the communication cannot be implemented properly, regardless of whether the VFD is running, the exception is not necessarily caused by interference. You can find out the causes as follows:

1. Check whether the 485 communication bus is disconnected or in poor contact.
2. Check whether the two ends of line A or B are connected reversely.
3. Check whether the communication protocol (such as the baud rate, data bits, and check bit) of the VFD is consistent with that of the upper computer.

If you are sure that communication exceptions are caused by interference, you can resolve the problem through the following measures:

1. Simple inspection.
2. Arrange the communication cables and motor cables in different cable trays.
3. In multi-VFD application scenarios, adopt the chrysanthemum connection mode to connect the communication cables between VFDs, which can improve the anti-interference capability.
4. In multi-VFD application scenarios, check and ensure that the driving capacity of the master is sufficient.
5. In the connection of multiple VFDs, you need to configure one 120 Ω terminal resistor on each end.

Solution:

1. Check and ensure that the ground wire of the motor is connected to the PE terminal of the VFD (if the ground wire of the motor has been connected to the ground block, you need to use a multimeter to measure and ensure that the resistance between the ground block and PE terminal is lower than 1.5 Ω).
2. Do not connect the VFD and motor to the same ground terminal as the upper computer. It is recommended that you connect the VFD and motor to the power ground, and connect the upper computer separately to a ground stud.
3. Try to short the signal reference ground terminal (GND) of the VFD with that of the upper computer controller to ensure that ground potential of the communication chip on the control board of the VFD is consistent with that of the communication chip of the upper computer.

4. Try to short GND of the VFD to its ground terminal (PE).
5. Try to add a safety capacitor of 0.1 μF on the power terminal of the upper computer (PLC, HMI, and touch screen). During this process, pay attention to the voltage of the power supply and the voltage endurance capability of the capacitor. Alternatively, you can use a magnet ring (Fe-based nanocrystalline magnet rings are recommended). Put the power L/N line or +/- line of the upper computer through the magnet ring in the same direction and wind 8 coils around the magnet ring.

7.7.3 Failure to stop and indicator shimmering due to motor cable coupling

Interference phenomenon:

1. Failure to stop

In a VFD system where an S terminal is used to control the start and stop, the motor cable and control cable are arranged in the same cable tray. After the system is started properly, the S terminal cannot be used to stop the VFD.

2. Indicator shimmering

After a VFD is started, the relay indicator, power distribution box indicator, PLC indicator, and indication buzzer shimmers, blinks, or emits unusual sounds unexpectedly.

Solution:

- (1) Check and ensure that the exception signal cable is arranged 20 cm or farther away from the motor cable.
- (2) Add a safety capacitor of 0.1 μF between the digital input terminal (S) and the COM terminal.
- (3) Connect the digital input terminal (S) that controls the start and stop to other idle digital input terminals in parallel. For example, if S1 is used to control the start and stop and S4 is idle, you can try to connect connect S1 to S4 in parallel.

Note: If the controller (such as PLC) in the system controls more than 5 VFDs at the same time through digital input terminals (S), this scheme is not available.

7.7.4 Leakage current and interference on RCD

VFDs output high-frequency PWM voltage to drive motors. In this process, the distributed capacitance between the internal IGBT of a VFD and the heat sink and that between the stator and rotor of a motor may inevitably cause the VFD to generate high-frequency leakage current to the ground. A residual current operated protective device (RCD) is used to detect the power-frequency leakage current when a grounding fault occurs on a circuit. The application of a VFD may cause misoperation of a RCD.

1. Rules for selecting RCDs

- (1) VFD systems are special. In these systems, it is required that the rated residual current of common RCDs at all levels is larger than 200 mA, and the VFDs are grounded reliably.
- (2) For RCDs, the time limit of an action needs to be longer than that of a next action, and the time difference between two actions need to be longer than 20 ms. For example, 1s, 0.5s, and 0.2s.

- (3) For circuits in VFD systems, electromagnetic RCDs are recommended. Electromagnetic RCDs have strong anti-interference capability, and thus can prevent the impact of high-frequency leakage current.

Electronic RCD	Electromagnetic RCD
Low cost, high sensitivity, small in volume, susceptible to voltage fluctuation of the grid and ambient temperature, weak anti-interference capability	Requiring highly sensitive, accurate, and stable zero-phase sequence current transformer, using permalloy high-permeability materials, complex process, high cost, not susceptible to voltage fluctuation of the power supply and ambient temperature, strong anti-interference capability

- 2. Solution to RCD misoperation (handling the VFD)
 - (1) Try to remove the jumper cap at "EMC/J10" on the middle casing of the VFD.
 - (2) Try to reduce the carrier frequency to 1.5 kHz (P00.14=1.5).
 - (3) Try to modify the modulation mode to "3PH modulation and 2PH modulation" (P8.40=0).
- 3. Solution to RCD misoperation (handling the system power distribution)
 - (1) Check and ensure that the power cable is not soaking in water.
 - (2) Check and ensure that the cables are not damaged or spliced.
 - (3) Check and ensure that no secondary grounding is performed on the neutral wire.
 - (4) Check and ensure that the main power cable terminal is in good contact with the air switch or contactor (all screws are tightened).
 - (5) Check 1PH powered devices, and ensure that no earth lines are used as neutral wires by these devices.
 - (6) Do not use shielded cables as VFD power cables and motor cables.

7.7.5 Live device chassis

Phenomenon

After a VFD is started, there is sensible voltage on the chassis, and you may feel an electric shock when touching the chassis. The chassis, however, is not live (or the voltage is far lower than the human safety voltage) when the VFD is powered on but not running.

Solution

- 1. If there is power distribution grounding or ground stud on the site, ground the cabinet chassis of the drive system through the power ground or stud.
- 2. If there is no grounding on the site, you need to connect the motor chassis to the ground terminal PE of the VFD, and ensure that the jumper at "EMC/J10" on the middle casing of the VFD is shorted.

8 Routine maintenance

8.1 What this chapter contains

This chapter describes how to carry out preventive maintenance on Goodrive350 IP54 high protection series VFDs.

8.2 Periodical inspection

Little maintenance is required when VFDs are installed in environments that meet requirements. The following table describes the routine maintenance periods recommended by INVT.

Subject		Item	Method	Criterion
Ambient environment		Check the temperature, and humidity, and whether there is vibration, dust, gas, oil spray, and water droplets in the environment.	Visual inspection, and use instruments for measurement.	The requirements stated in this manual are met.
		Check whether there are foreign matters, such as tools, or dangerous substances placed nearby.	Visual inspection	There are no tools or dangerous substances placed nearby.
Voltage		Check the voltage of the main circuit and control circuit.	Use multimeters or other instruments for measurement.	The requirements stated in this manual are met.
Keypad		Check the display of information.	Visual inspection	The characters are displayed properly.
		Check whether characters are not completely displayed.	Visual inspection	The requirements stated in this manual are met.
Main circuit	Common	Check whether the bolts loose or come off.	Screw them up.	No exception occurs.
		Check whether the machine is deformed, cracked, or damaged, or their color changes due to overheating and aging.	Visual inspection	No exception occurs.
		Check whether there are stains and dust attached.	Visual inspection	No exception occurs. Note: Discoloration of copper bars does not mean that they

Subject	Item	Method	Criterion
			cannot work properly.
Conductor and wire	Check whether the conductors are deformed or their color change due to overheat.	Visual inspection	No exception occurs.
	Check whether the wire sheaths are cracked or their color changes.	Visual inspection	No exception occurs.
Terminal block	Check whether there is damage.	Visual inspection	No exception occurs.
Filter capacitor	Check whether there is electrolyte leakage, discoloration, cracks, and chassis expansion.	Visual inspection	No exception occurs.
	Check whether the safety valves are released.	Determine the service life based on the maintenance information, or measure them through electrostatic capacity.	No exception occurs.
	Check whether the electrostatic capacity is measured as required.	Use instruments to measure the capacity.	Electrostatic capacity \geq initial value \times 0.85
Resistor	Check whether there is displacement caused due to overheat.	Olfactory and visual inspection	No exception occurs.
	Check whether the resistors are disconnected.	Visual inspection, or remove one end of the connection cable and use a multimeter for measurement.	Resistance range: $\pm 10\%$ (of the standard resistance)
Transformer and reactor	Check whether there is unusual vibration sounds or smells.	Auditory, olfactory, and visual inspection	No exception occurs.

Subject		Item	Method	Criterion
	Electromagnetic contactor and relay	Check whether there are vibration sounds in the workshop.	Auditory inspection	No exception occurs.
		Check whether the contacts are in good contact.	Visual inspection	No exception occurs.
Control circuit	Control PCB, connector	Check whether the screws and connectors loose.	Screw them up.	No exception occurs.
		Check whether there is unusual smell or discoloration.	Olfactory and visual inspection	No exception occurs.
		Check whether there are cracks, damage, deformation, or rust.	Visual inspection	No exception occurs.
		Check whether there is electrolyte leakage or deformation.	Visual inspection, and determine the service life based on the maintenance information.	No exception occurs.
Cooling system	Cooling fan	Check whether there are unusual sounds or vibration.	Auditory and visual inspection, and turn the fan blades with your hand.	The rotation is smooth.
		Check whether the bolts loose.	Screw them up.	No exception occurs.
		Check whether there is decoloration caused due to overheat.	Visual inspection, and determine the service life based on the maintenance information.	No exception occurs.
	Ventilation duct	Check whether there are foreign matters blocking or attached to the cooling fan, air inlets, or air outlets.	Visual inspection	No exception occurs.

For more details about maintenance, contact the local INVT office, or visit our website <http://www.invt.com>, and choose **Support > Service**.

8.3 Cooling fan

The service life of the cooling fan of the VFD is more than 25,000 hours. The actual service life of the cooling fan is related to the use of the VFD and the temperature in the ambient environment.

You can view the running duration of the VFD through P07.14 (Accumulated running time).

The increase of the bearing noise indicates a fan fault. If the VFD is applied in a key position, replace the fan once the fan starts to generate unusual noise. You can purchase spare parts of fans from INVT.

Cooling fan replacement

	<p>◇ Read 1 "Safety precautions" carefully and follow the instructions to perform operations. Otherwise, physical injuries or damage to the device may be caused.</p>
---	---

1. Stop the device, disconnect the AC power supply, and wait for a time no shorter than the waiting time designated on the VFD.
2. Open the cable clamp to loose the fan cable (for VFDs of 004G/5R5P-030G/037P, the middle casing needs to be removed).
3. Remove the fan cable.
4. Remove the fan with a screwdriver.
5. Install a new fan in the VFD in the reverse steps. Assemble the VFD. Ensure that the air direction of the fan is consistent with that of the VFD, as shown in the Fig 8.1.
6. Power on the VFD.

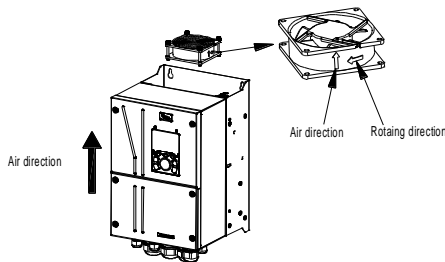

Figure 8-1 Fan maintenance for VFDs of 7R5G/011P or higher

8.4 Capacitor

8.4.1 Capacitor reforming

If the VFD has been left unused for a long time, you need to follow the instructions to reform the DC bus capacitor before using it. The storage time is calculated from the date the VFD is delivered.

Storage time	Operation principle
Less than 1 year	No charging operation is required.
1 to 2 years	The VFD needs to be powered on for 1 hour before the first running command.

Storage time	Operation principle
2 to 3 years	Use a voltage controlled power supply to charge the VFD: Charge the VFD at 25% of the rated voltage for 30 minutes, and then charge it at 50% of the rated voltage for 30 minutes, at 75% for another 30 minutes, and finally charge it at 100% of the rated voltage for 30 minutes.
More than 3 years	Use a voltage controlled power supply to charge the VFD: Charge the VFD at 25% of the rated voltage for 2 hours, and then charge it at 50% of the rated voltage for 2 hours, at 75% for another 2 hours, and finally charge it at 100% of the rated voltage for 2 hours.

The method for using a voltage controlled power supply to charge the VFD is described as follows:

The selection of a voltage controlled power supply depends on the power supply of the VFD. For VFDs with an incoming voltage of 1PH/3PH 230 V AC, you can use a 230 V AC/2 A voltage regulator. Both 1PH and 3PH VFDs can be charged with a 1PH voltage controlled power supply (connect L+ to R, and N to S or T). All the DC bus capacitors share one rectifier, and therefore they are all charged.

For VFDs of a high voltage class, ensure that the voltage requirement (for example, 380 V) is met during charging. Capacitor charging requires little current, and therefore you can use a small-capacity power supply (2 A is sufficient).

The method for using a resistor (incandescent lamp) to charge the drive is described as follows:

If you directly connect the drive device to a power supply to charge the DC bus capacitor, it needs to be charged for a minimum of 60 minutes. The charging operation must be performed at a normal indoor temperature without load, and you must connect a resistor in series mode in the 3PH circuit of the power supply.

For a 380 V drive device, use a resistor of 1 kΩ/100W. If the voltage of the power supply is no higher than 380 V, you can also use an incandescent lamp of 100W. If an incandescent lamp is used, it may go off or the light may become very weak.

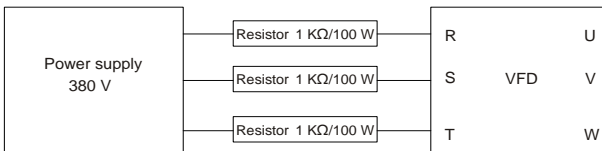

Figure 8–2 Charging circuit example of driving devices of 380 V

8.4.2 Electrolytic capacitor replacement

	<p>⚠ Read 1 "Safety precautions" carefully and follow the instructions to perform operations. Otherwise, physical injuries or damage to the device may be caused.</p>
--	---

The electrolytic capacitor of a VFD must be replaced if it has been used for more than 35,000 hours. For details about the replacement, contact the local INVT office.

8.5 Power cable



◇ Read 1 "Safety precautions" carefully and follow the instructions to perform operations. Otherwise, physical injuries or damage to the device may be caused.

1. Stop the VFD, disconnect the power supply, and wait for a time no shorter than the waiting time designated on the VFD.
2. Check the connection of the power cables. Ensure that they are firmly connected.
3. Power on the VFD.

9 Communication protocol

9.1 What this chapter contains

This chapter describes the communication protocol of Goodrive350 IP54 high protection high-ingress protection Goodrive350 series products.

Goodrive350 IP54 high protection high-ingress protection Goodrive350 series VFDs provide RS485 communication interfaces and adopt the master-slave communication based on the international standard Modbus communication protocol. You can implement centralized control (setting commands for controlling the VFD, modifying the running frequency and related function code parameters, and monitoring the working state and fault information of the VFD) through PC/PLC, upper control computer, or other devices to meet specific application requirements.

9.2 Modbus protocol introduction

Modbus is a software protocol, a common language used in electronic controllers. By using this protocol, a controller can communicate with other devices through transmission lines. It is a general industrial standard. With this standard, control devices produced by different manufacturers can be connected to form an industrial network and be monitored in a centralized way.

The Modbus protocol provides two transmission modes, namely American Standard Code for Information Interchange (ASCII) and remote terminal units (RTU). On one Modbus network, all the device transmission modes, baud rates, data bits, check bits, end bits, and other basic parameters must be set consistently.

A Modbus network is a control network with one master and multiple slaves, that is, on one Modbus network, there is only one device serving as the master, and other devices are the slaves. The master can communicate with one slave or broadcast messages to all the slaves. For separate access commands, a slave needs to return a response. For broadcasted information, slaves do not need to return responses.

9.3 Application of Modbus

Goodrive350 IP54 high-ingress protection series VFDs use the RTU mode provided by the Modbus protocol, and RS485 interfaces are used.

9.3.1 RS485

RS485 interfaces work in half-duplex mode and transmit data signals in the differential transmission way, which is also referred to as balanced transmission. An RS485 interface uses a twisted pair, where one wire is defined as A (+), and the other B (-). Generally, if the positive electrical level between the transmission drives A and B ranges from +2 V to +6 V, the logic is "1"; and if it ranges from -2 V to -6 V, the logic is "0".

The 485+ terminal on the terminal block of the VFD corresponds to A, and 485- corresponds to B.

The communication baud rate (P14.01) indicates the number of bits transmitted in a second, and the unit is bit/s (bps). A higher baud rate indicates faster transmission and poorer anti-interference

capability. When a twisted pair of 0.56 mm (24 AWG) is used, the maximum transmission distance varies according to the baud rate, as described in the following table.

Baud rate (bps)	Max. transmission distance	Baud rate (bps)	Max. transmission distance
2400	1800 m	9600	800 m
4800	1200 m	19200	600 m

When RS485 interfaces are used for long-distance communication, it is recommended that you use shielded cables, and use the shield layer as the ground wires.

When there are fewer devices and the transmission distance is short, the whole network works well without terminal load resistors. The performance, however, degrades as the distance increases. Therefore, it is recommended that you use a 120 Ω terminal resistor when the transmission distance is long.

9.3.1.1 Application to one VFD

Figure 9–1 is the Modbus wiring diagram of one VFD and a PC. Generally, PCs do not provide RS485 interfaces, so you need to convert an RS232 interface or USB port of a PC to an RS485 interface. Connect end A of the RS485 interface to the 485+ port on the terminal block of the VFD, and connect end B to the 485- port. It is recommended that you use shielded twisted pairs. When an RS232-RS485 converter is used, the cable used to connect the RS232 interface of the PC and the converter cannot be longer than 15 m. Use a short cable when possible. It is recommended that you insert the converter directly into the PC. Similarly, when a USB-RS485 converter is used, use a short cable when possible.

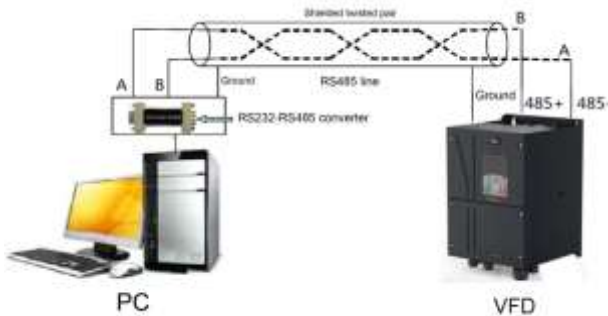

Figure 9–1 Wiring of RS485 applied to one VFD

9.3.1.2 Application to multiple VFDs

In practical application to multiple VFDs, chrysanthemum connection and star connection are commonly used.

According to the requirements of the RS485 industrial bus standards, all the devices need to be connected in chrysanthemum mode with one 120 Ω terminal resistor on each end, as shown in Figure

9-2. Figure 9-3 is the simplified wiring diagram, and Figure 9-4 is the practical application diagram.

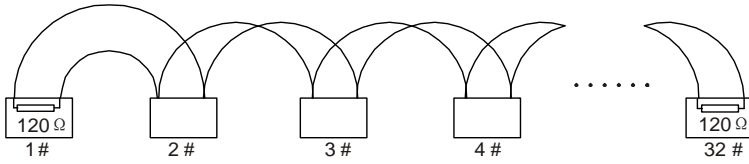

Figure 9-2 On-site chrysanthemum connection diagram

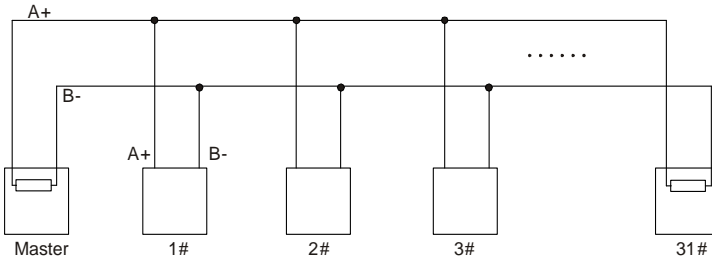

Figure 9-3 Simplified chrysanthemum connection diagram

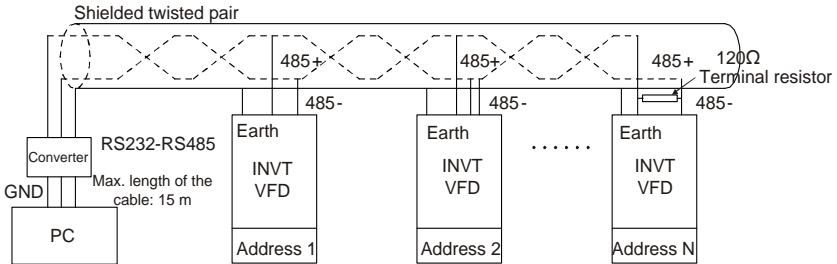

Figure 9-4 Practical application diagram of chrysanthemum connection

Figure 9-5 shows the start connection diagram. When this connection mode is adopted, the two devices that are farthest away from each other on the line must be connected with a terminal resistor (in Figure 9-5, the two devices are devices 1# and 15#).

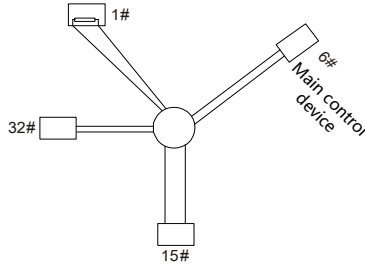

Figure 9–5 Star connection

Use shielded cable, if possible, in multi-device connection. The baud rates, data bit check settings, and other basic parameters of all the devices on the RS485 line must be set consistently, and addresses cannot be repeated.

9.3.2 RTU mode

9.3.2.1 RTU communication frame structure

When a controller is set to use the RTU communication mode on a Modbus network, every byte (8 bits) in the message includes 2 hexadecimal characters (each includes 4 bits). Compared with the ASCII mode, the RTU mode can transmit more data with the same baud rate.

Code system

- 1 start bit
- 7 or 8 data bits; the minimum valid bit is transmitted first. Each frame domain of 8 bits includes 2 hexadecimal characters (0–9, A–F).
- 1 odd/even check bit; this bit is not provided if no check is needed.
- 1 end bit (with check performed), 2 bits (without check)

Error detection domain

- Cyclic redundancy check (CRC)

The following table describes the data format.

11-bit character frame (Bits 1 to 8 are data bits)

Start bit	BIT1	BIT2	BIT3	BIT4	BIT5	BIT6	BIT7	BIT8	Check bit	End bit
-----------	------	------	------	------	------	------	------	------	-----------	---------

10-bit character frame (Bits 1 to 7 are data bits)

Start bit	BIT1	BIT2	BIT3	BIT4	BIT5	BIT6	BIT7	Check bit	End bit
-----------	------	------	------	------	------	------	------	-----------	---------

In a character frame, only the data bits carry information. The start bit, check bit, and end bit are used to facilitate the transmission of the data bits to the destination device. In practical applications, you must set the data bits, parity check bits, and end bits consistently.

In RTU mode, the transmission of a new frame always starts from an idle time (the transmission time of 3.5 bytes). On a network where the transmission rate is calculated based on the baud rate, the transmission time of 3.5 bytes can be easily obtained. After the idle time ends, the data domains are transmitted in the following sequence: slave address, operation command code, data, and CRC check character. Each byte transmitted in each domain includes 2 hexadecimal characters (0–9, A–F). The network devices always monitor the communication bus. After receiving the first domain (address information), each network device identifies the byte. After the last byte is transmitted, a similar transmission interval (the transmission time of 3.5 bytes) is used to indicate that the transmission of the frame ends. Then, the transmission of a new frame starts.

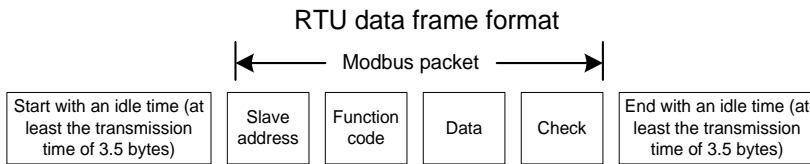

The information of a frame must be transmitted in a continuous data flow. If there is an interval greater than the transmission time of 1.5 bytes before the transmission of the entire frame is complete, the receiving device deletes the incomplete information, and mistakes the subsequent byte for the address domain of a new frame. Similarly, if the transmission interval between two frames is shorter than the transmission time of 3.5 bytes, the receiving device mistakes it for the data of the last frame. The CRC check value is incorrect due to the disorder of the frames, and thus a communication fault occurs.

The following table describes the standard structure of an RTU frame.

START (frame header)	T1-T2-T3-T4 (transmission time of 3.5 bytes)
ADDR (slave address domain)	Communication address: 0–247 (decimal system) (0 is the broadcast address)
CMD (function domain)	03H: read slave parameters 06H: write slave parameters
DATA (N-1) ... DATA (0) (data domain)	Data of 2×N bytes, main content of the communication as well as the core of data exchanging
CRC CHK (LSBs)	Detection value: CRC (16 bits)
CRC CHK high bit (MSBs)	
END (frame tail)	T1-T2-T3-T4 (transmission time of 3.5 bytes)

9.3.2.2 RTU communication frame error check modes

During the transmission of data, errors may occur due to various factors. Without check, the data receiving device cannot identify data errors and may make a wrong response. The wrong response

may cause severe problems. Therefore, the data must be checked.

The check is implemented as follows: The transmitter calculates the to-be-transmitted data based on a specific algorithm to obtain a result, adds the result to the rear of the message, and transmits them together. After receiving the message, the receiver calculates the data based on the same algorithm to obtain a result, and compares the result with that transmitted by the transmitter. If the results are the same, the message is correct. Otherwise, the message is considered wrong.

The error check of a frame includes two parts, namely, bit check on individual bytes (that is, odd/even check using the check bit in the character frame), and whole data check (CRC check).

Bit check on individual bytes (odd/even check)

You can select the bit check mode as required, or you can choose not to perform the check, which will affect the check bit setting of each byte.

Definition of even check: Before the data is transmitted, an even check bit is added to indicate whether the number of "1" in the to-be-transmitted data is odd or even. If it is even, the check bit is set to "0"; and if it is odd, the check bit is set to "1".

Definition of odd check: Before the data is transmitted, an odd check bit is added to indicate whether the number of "1" in the to-be-transmitted data is odd or even. If it is odd, the check bit is set to "0"; and if it is even, the check bit is set to "1".

For example, the data bits to be transmitted are "11001110", including five "1". If the even check is applied, the even check bit is set to "1"; and if the odd check is applied, the odd check bit is set to "0". During the transmission of the data, the odd/even check bit is calculated and placed in the check bit of the frame. The receiving device performs the odd/even check after receiving the data. If it finds that the odd/even parity of the data is inconsistent with the preset information, it determines that a communication error occurs.

CRC check mode

A frame in the RTU format includes an error detection domain based on the CRC calculation. The CRC domain checks all the content of the frame. The CRC domain consists of two bytes, including 16 binary bits. It is calculated by the transmitter and added to the frame. The receiver calculates the CRC of the received frame, and compares the result with the value in the received CRC domain. If the two CRC values are not equal to each other, errors occur in the transmission.

During CRC, 0xFFFF is stored first, and then a process is invoked to process a minimum of 6 contiguous bytes in the frame based on the content in the current register. CRC is valid only for the 8-bit data in each character. It is invalid for the start, end, and check bits.

During the generation of the CRC values, the "exclusive or" (XOR) operation is performed on the each 8-bit character and the content in the register. The result is placed in the bits from the least significant bit (LSB) to the most significant bit (MSB), and 0 is placed in the MSB. Then, LSB is detected. If LSB is 1, the XOR operation is performed on the current value in the register and the preset value. If LSB is 0, no operation is performed. This process is repeated 8 times. After the last bit (8th bit) is detected and processed, the XOR operation is performed on the next 8-bit byte and the

current content in the register. The final values in the register are the CRC values obtained after operations are performed on all the bytes in the frame.

The calculation adopts the international standard CRC check rule. You can refer to the related standard CRC algorithm to compile the CRC calculation program as required.

The following is a simple CRC calculation function for your reference (using the C programming language):

```
unsigned int  crc_cal_value(unsigned char*data_value,unsigned char
data_length)
{
    int i;
    unsigned int crc_value=0xffff;
    while(data_length--)
    {
        crc_value^=*data_value++;
        for(i=0;i<8;i++)
        {
            if(crc_value&0x0001)
                crc_value=(crc_value>>1)^0xa001;
            else
                crc_value=crc_value>>1;
        }
    }
    return(crc_value);
}
```

In the ladder logic, CKSM uses the table look-up method to calculate the CRC value according to the content in the frame. The program of this method is simple, and the calculation is fast, but the ROM space occupied is large. Use this program with caution in scenarios where there are space occupation limits on programs.

9.4 RTU command code and communication data

9.4.1 Command code: 03H, reading N words

Continuously reading a maximum of 16 words

The command code 03H is used by the master to read data from the VFD. The quantity of data to be read depends on the "data quantity" in the command. A maximum of 16 pieces of data can be read. The addresses of the read parameters must be contiguous. Each piece of data occupies 2 bytes, that is, one word. The command format is presented using the hexadecimal system (a number followed by "H" indicates a hexadecimal value). One hexadecimal value occupies one byte.

The 03H command is used to read information including the parameters and operation state of the VFD.

For example, starting from the data address of 0004H, to read two contiguous pieces of data (that is,

to read content from the data addresses 0004H and 0005H), the structure of the frame is described in the following table.

RTU master command (transmitted by the master to the VFD)

START	T1-T2-T3-T4 (transmission time of 3.5 bytes)
ADDR (address)	01H
CMD (command code)	03H
Most significant byte (MSB) of the start address	00H
Least significant byte (LSB) of the start address	04H
MSB of data quantity	00H
LSB of data quantity	02H
LSB of CRC	85H
MSB of CRC	CAH
END	T1-T2-T3-T4 (transmission time of 3.5 bytes)

The value in START and END is "T1-T2-T3-T4 (transmission time of 3.5 bytes)", indicating that the RS485 needs to stay idle for at least the transmission time of 3.5 bytes. An idle time is required to distinguish on message from another to ensure that the two messages are not regarded as one.

The value of ADDR is 01H, indicating that the command is transmitted to the VFD whose address is 01H. The ADDR information occupies one byte.

The value of CMD is 03H, indicating that the command is used to read data from the VFD. The CMD information occupies one byte.

"Start address" indicates that data reading is started from this address. It occupies two bytes, with the MSB on the left and LSB on the right.

"Data quantity" indicates the quantity of data to be read (unit: word).

The value of "Start address" is 0004H, and that of "Data quantity" is 0002H, indicating that data is to be read from the data addresses of 0004H and 0005H.

CRC check occupies two bytes, with the LSB on the left, and MSB on the right.

RTU slave response (transmitted by the VFD to the master)

START	T1-T2-T3-T4 (transmission time of 3.5 bytes)
ADDR	01H
CMD	03H
Number of bytes	04H
MSB of data in 0004H	13H
LSB of data in 0004H	88H
MSB of data in 0005H	00H

LSB of data in 0005H	00H
LSB of CRC	7EH
MSB of CRC	9DH
END	T1-T2-T3-T4 (transmission time of 3.5 bytes)

The definition of the response information is described as follows:

The value of ADDR is 01H, indicating that the message is transmitted by the VFD whose address is 01H. The ADDR information occupies one byte.

The value of CMD is 03H, indicating that the message is a response of the VFD to the 03H command of the master for reading data. The CMD information occupies one byte.

"Number of bytes" indicates the number of bytes between a byte (not included) and the CRC byte (not included). The value 04 indicates that there are four bytes of data between "Number of bytes" and "LSB of CRC", that is, "MSB of data in 0004H", "LSB of data in 0004H", "MSB of data in 0005H", and "LSB of data in 0005H".

A piece of data is two bytes, with the MSB on the left and LSB on the right. From the response, we can see that the data in 0004H is 1388H, and that in 0005H is 0000H.

CRC check occupies two bytes, with the LSB on the left, and MSB on the right.

9.4.2 Command code: 06H, writing a word

This command is used by the master to write data to the VFD. One command can be used to write only one piece of data. It is used to modify the parameters and operation mode of the VFD.

For example, to write 5000 (1388H) to 0004H of the VFD whose address is 02H, the structure of the frame is described in the following table.

RTU master command (transmitted by the master to the VFD)

START	T1-T2-T3-T4 (transmission time of 3.5 bytes)
ADDR	02H
CMD	06H
MSB of data writing address	00H
LSB of data writing address	04H
MSB of to-be-written data	13H
LSB of to-be-written data	88H
LSB of CRC	C5H
MSB of CRC	6EH
END	T1-T2-T3-T4 (transmission time of 3.5 bytes)

RTU slave response (transmitted by the VFD to the master)

START	T1-T2-T3-T4 (transmission time of 3.5 bytes)
ADDR	02H
CMD	06H

MSB of data writing address	00H
LSB of data writing address	04H
MSB of to-be-written data	13H
LSB of to-be-written data	88H
LSB of CRC	C5H
MSB of CRC	6EH
END	T1-T2-T3-T4 (transmission time of 3.5 bytes)

Note: The sections 9.4.1 and 9.4.2 mainly describes the command formats. For the detailed application, see the examples in section 9.4.8 "Read/Write operation example".

9.4.3 Command code: 08H, diagnosis

Sub-function code description

Sub-function code	Description
0000	Return data based on query requests

For example, to query about the circuit detection information about the VFD whose address is 01H, the query and return strings are the same, and the format is described in the following tables.

RTU master command

START	T1-T2-T3-T4 (transmission time of 3.5 bytes)
ADDR	01H
CMD	08H
MSB of the sub-function code	00H
LSB of the sub-function code	00H
MSB of data	12H
LSB of data	ABH
LSB of CRC CHK	ADH
MSB of CRC CHK	14H
END	T1-T2-T3-T4 (transmission time of 3.5 bytes)

RTU slave response

START	T1-T2-T3-T4 (transmission time of 3.5 bytes)
ADDR	01H
CMD	08H
MSB of the sub-function code	00H
LSB of the sub-function code	00H
MSB of data	12H
LSB of data	ABH
LSB of CRC CHK	ADH
MSB of CRC CHK	14H
END	T1-T2-T3-T4 (transmission time of 3.5 bytes)

9.4.4 Command code: 10H, continuous writing

The command code 10H is used by the master to write data to the VFD. The quantity of data to be written is determined by "Data quantity", and a maximum of 16 pieces of data can be written.

For example, to write 5000 (1388H) and 50 (0032H) respectively to 0004H and 0005H of the VFD whose slave address is 02H, the structure of the frame is described in the following table.

RTU master command (transmitted by the master to the VFD)

START	T1-T2-T3-T4 (transmission time of 3.5 bytes)
ADDR	02H
CMD	10H
MSB of data writing address	00H
LSB of data writing address	04H
MSB of data quantity	00H
LSB of data quantity	02H
Number of bytes	04H
MSB of data to be written to 0004H	13H
LSB of data to be written to 0004H	88H
MSB of data to be written to 0005H	00H
LSB of data to be written to 0005H	32H
LSB of CRC	C5H
MSB of CRC	6EH
END	T1-T2-T3-T4 (transmission time of 3.5 bytes)

RTU slave response (transmitted by the VFD to the master)

START	T1-T2-T3-T4 (transmission time of 3.5 bytes)
ADDR	02H
CMD	10H
MSB of data writing address	00H
LSB of data writing address	04H
MSB of data quantity	00H
LSB of data quantity	02H
LSB of CRC	C5H
MSB of CRC	6EH
END	T1-T2-T3-T4 (transmission time of 3.5 bytes)

9.4.5 Data address definition

This section describes the address definition of communication data. The addresses are used for controlling the running, obtaining the state information, and setting related function parameters of the VFD.

9.4.5.1 Function code address representation rules

The address of a function code consists of two bytes, with the MSB on the left and LSB on the right. The MSB ranges from 00 to ffH, and the LSB also ranges from 00 to ffH. The MSB is the hexadecimal form of the group number before the dot mark, and LSB is that of the number behind the dot mark. Take P05.06 as an example, the group number is 05, that is, the MSB of the parameter address is the hexadecimal form of 05; and the number behind the dot mark is 06, that is, the LSB is the hexadecimal form of 06. Therefore, the function code address is 0506H in the hexadecimal form. For P10.01, the parameter address is 0A01H.

Function code	Name	Detailed parameter description	Setting range	Default value	Modify
P10.00	Simple PLC mode	0: Stop after running once 1: Keep running in the final value after running once 2: Cyclic running	0-2	0	<input type="radio"/>
P10.01	Simple PLC memory selection	0: No memory after power down 1: Memory after power down	0-1	0	<input type="radio"/>

Note:

- The parameters in the P99 group are set by the manufacturer. They cannot be read or modified. Some parameters cannot be modified when the VFD is running; some cannot be modified regardless of the state of the VFD. Pay attention to the setting range, unit, and related description of a parameter when modifying it.
- The service life of the Electrically Erasable Programmable Read-Only Memory (EEPROM) may be reduced if it is frequently used for storage. For users, some function codes do not need to be stored during communication. The application requirements can be met by modifying the value of the on-chip RAM, that is, modifying the MSB of the corresponding function code address from 0 to 1. For example, if P00.07 is not to be stored in the EEPROM, you need only to modify the value of the RAM, that is, set the address to 8007H. The address can be used only for writing data to the on-chip RAM, and it is invalid when used for reading data.

9.4.5.2 Description of other function code addresses

In addition to modifying the parameters of the VFD, the master can also control the VFD, such as start and stop it, and monitor the operation state of the VFD. The following table describes other function parameters.

Function	Address	Data description	R/W
Communication-based control command	2000H	0001H: Forward running	R/W
		0002H: Reverse running	
		0003H: Forward jogging	
		0004H: Reverse jogging	

Function	Address	Data description	R/W
		0005H: Stop	
		0006H: Coast to stop	
		0007H: Fault reset	
		0008H: Jogging to stop	
Communication-based value setting	2001H	Communication-based frequency setting (0–Fmax, unit: 0.01 Hz)	R/W
	2002H	PID setting, range (0–1000, 1000 corresponding to 100.0%)	
	2003H	PID feedback, range (0–1000, 1000 corresponding to 100.0%)	R/W
	2004H	Torque setting (-3000→+3000, 1000 corresponding to 100.0% of the rated current of the motor)	R/W
	2005H	Setting of the upper limit of the forward running frequency (0–Fmax, unit: 0.01 Hz)	R/W
	2006H	Setting of the upper limit of the reverse running frequency (0–Fmax, unit: 0.01 Hz)	R/W
	2007H	Upper limit of the electromotion torque (0–3000, 1000 corresponding to 100.0% of the rated current of the VFD)	R/W
	2008H	Upper limit of the brake torque (0–3000, 1000 corresponding to 100.0% of the rated current of the motor)	R/W
	2009H	Special control command word: Bit1–0: =00: Motor 1 =01: Motor 2 =10: Motor 3 =11: Motor 4 Bit2: =1 Torque control disabled =0: Torque control cannot be disabled Bit3: =1 Power consumption reset to 0 =0: Power consumption not reset Bit4: =1 Pre-excitation =0: Pre-excitation disabled Bit5: =1 DC brake =0: DC brake disabled	R/W
	200AH	Virtual input terminal command, range: 0x000–0x3FF Corresponding to S8/S7/S6/S5/HDIB/HDIA/S4/S3/ S2/S1	R/W

Function	Address	Data description	R/W
	200BH	Virtual output terminal command, range: 0x00–0x0F Corresponding to local RO2/RO1/HDO/Y1	R/W
	200CH	Voltage setting (used when V/F separation is implemented) (0–1000, 1000 corresponding to 100.0% of the rated voltage of the motor)	R/W
	200DH	AO output setting 1 (-1000→+1000, 1000 corresponding to 100.0%)	R/W
	200EH	AO output setting 2 (-1000→+1000, 1000 corresponding to 100.0%)	R/W
VFD state word 1	2100H	0001H: Forward running	R
		0002H: Reverse running	
		0003H: Stopped	
		0004H: Faulty	
		0005H: POFF	
		0006H: Pre-excited	
VFD state word 2	2101H	Bit0: =0: Not ready to run =1: Ready to run Bi2–1: =00: Motor 1 =01: Motor 2 =10: Motor 3 =11: Motor 4 Bit3: =0: Asynchronous machine =1: Synchronous machine Bit4: =0: No overload alarm =1: Overload alarm Bit6–Bit5: =00: Keypad-based control =01: Terminal-based control =10: Communication-based control Bit7: reserved Bit8: =0: speed control =1: torque control Bit9: =0: not for position control =1: position control Bit11–10: =0:vector 0 =1: vector 1 =2: Closed-loop vector =3: SVPWM	R
VFD fault code	2102H	See the description of fault types.	R
VFD identification code	2103H	GD35----0x0109	R
Running frequency	3000H	0–Fmax (unit: 0.01Hz)	Compatible with CHF100A
Set frequency	3001H	0–Fmax (unit: 0.01Hz)	

Function	Address	Data description	R/W	
Bus voltage	3002H	0.0–2000.0 V (unit: 0.1V)	and CHV100 communication addresses	
Output voltage	3003H	0–1200V (unit: 1V)		
Output current	3004H	0.0–3000.0A (unit: 0.1A)		
Rotating speed	3005H	0–65535 (unit: 1RPM)		
Output power	3006H	-300.0–+300.0% (unit: 0.1%)		
Output torque	3007H	-250.0–+250.0% (unit: 0.1%)		
Closed-loop setting	3008H	-100.0–+100.0% (unit: 0.1%)		
Closed-loop feedback	3009H	-100.0–+100.0% (unit: 0.1%)		
Input state	300AH	000–3F Corresponding to the local HDIB/ HDIA/S4/S3/S2/S1		R
Output state	300BH	000–0F Corresponding to the local RO2/RO1/HDO/Y1		R
Analog input 1	300CH	0.00–10.00V (unit: 0.01V)		R
Analog input 2	300DH	0.00–10.00V (unit: 0.01V)		R
Analog input 3	300EH	-10.00–10.00V (unit: 0.01V)		R
Analog input 4	300FH			R
Read input of high-speed pulse 1	3010H	0.00–50.00kHz (unit: 0.01Hz)	R	
Read input of high-speed pulse 2	3011H		R	
Read current step of multi-step speed	3012H	0–15	R	
External length	3013H	0–65535	R	
External count value	3014H	0–65535	R	
Torque setting	3015H	-300.0–+300.0% (unit: 0.1%)	R	
Identification code	3016H		R	
Fault code	5000H		R	

The Read/Write (R/W) characteristics indicate whether a function can be read and written. For example, "Communication-based control command" can be written, and therefore the command code 6H is used to control the VFD. The R characteristic indicates that a function can only be read, and W indicates that a function can only be written.

Note: Some parameters in the preceding table are valid only after they are enabled. Take the running and stop operations as examples, you need to set "Running command channel" (P00.01) to "Communication", and set "Communication running command channel" (P00.02) to the Modbus communication channel. For another example, when modifying "PID setting", you need to set "PID reference source" (P09.00) to Modbus communication.

The following table describes the encoding rules of device codes (corresponding to the identification code 2103H of the VFD).

8 MSBs	Meaning	8 LSBs	Meaning
01	GD	0x08	GD35 vector VFD
		0x09	GD35-H1 vector VFD
		0x0a	GD300 vector VFD
		0xa0	GD350 vector VFD

9.4.6 Fieldbus scale

In practical applications, communication data is represented in the hexadecimal form, but hexadecimal values cannot represent decimals. For example, 50.12 Hz cannot be represented in the hexadecimal form. In such cases, we can multiply 50.12 by 100 to obtain an integer 5012, and then 50.12 can be represented as 1394H (5012 in the decimal form) in the hexadecimal form.

In the process of multiplying a non-integer by a multiple to obtain an integer, the multiple is referred to as a fieldbus scale.

The fieldbus scale depends on the number of decimals in the value specified in "Detailed parameter description" or "Default value". If there are n decimals in the value, the fieldbus scale m is the n^{th} -power of 10. Take the following table as an example, m is 10.

Function code	Name	Detailed parameter description	Default value
P01.20	Wake-up-from-sleep delay	0.0–3600.0s (valid when P01.19 is 2)	0.0s
P01.21	Restart after power cut	0: Restart is disabled 1: Restart is enabled	0

The value specified in "Detailed parameter description" or "Default value" contains one decimal, so the fieldbus scale is 10. If the value received by the upper computer is 50, the value of "Wake-up-from-sleep delay" of the VFD is 5.0 (5.0=50/10).

To set the "Wake-up-from-sleep delay" to 5.0s through Modbus communication, you need first to multiply 5.0 by 10 according to the scale to obtain an integer 50, that is, 32H in the hexadecimal form, and then transmit the following write command:

01	06	01 14	00 32	49 E7
VFD address	Write command	Parameter address	Parameter data	CRC

After receiving the command, the VFD converts 50 into 5.0 based on the fieldbus scale, and then sets "Wake-up-from-sleep delay" to 5.0s.

For another example, after the upper computer transmits the "Wake-up-from-sleep delay" parameter read command, the master receives the following response from the VFD:

<u>01</u>	<u>03</u>	<u>02</u>	<u>00 32</u>	<u>39 91</u>
VFD address	Read command	2-byte data	Parameter data	CRC

The parameter data is 0032H, that is, 50, so 5.0 is obtained based on the fieldbus scale (50/10=5.0). In this case, the master identifies that the "Wake-up-from-sleep delay" is 5.0s.

9.4.7 Error message response

Operation errors may occur in communication-based control. For example, some parameters can only be read, but a write command is transmitted. In this case, the VFD returns an error message response.

Error message responses are transmitted by the VFD to the master. The following table describes the codes and definitions of the error message responses.

Code	Name	Definition
01H	Invalid command	The command code received by the upper computer is not allowed to be executed. The possible causes are as follows: <ul style="list-style-type: none"> ● The function code is applicable only on new devices and is not implemented on this device. ● The slave is in the faulty state when processing this request.
02H	Invalid data address	For the VFD, the data address in the request of the upper computer is not allowed. In particular, the combination of the register address and the number of the to-be-transmitted bytes is invalid.
03H	Invalid data bit	The received data domain contains a value that is not allowed. The value indicates the error of the remaining structure in the combined request. Note: It does not mean that the data item submitted for storage in the register includes a value unexpected by the program.
04H	Operation failure	The parameter is set to an invalid value in the write operation. For example, a function input terminal cannot be set repeatedly.
05H	Password error	The password entered in the password verification address is different from that set in P03.00.
06H	Data frame error	The length of the data frame transmitted by the upper computer is incorrect, or in the RTU format, the value of the CRC check bit is inconsistent with the CRC value calculated by the lower computer
07H	Parameter read-only	The parameter to be modified in the write operation of the upper computer is a read-only parameter.
08H	Parameter cannot be modified in running	The parameter to be modified in the write operation of the upper computer cannot be modified during the running of the VFD.

Code	Name	Definition
09H	Password protection	A user password is set, and the upper computer does not provide the password to unlock the system when performing a read or write operation. The error of "system locked" is reported.

When returning a response, the device uses a function code domain and fault address to indicate whether it is a normal response (no error) or exception response (some errors occur). In a normal response, the device returns the corresponding function code and data address or sub-function code. In an exception response, the device returns a code that is equal to a normal code, but the first bit is logic 1.

For example, if the master device transmits a request message to a slave device for reading a group of function code address data, the code is generated as follows:

0 0 0 0 0 1 1 (03H in the hexadecimal form)

For a normal response, the same code is returned.

For an exception response, the following code is returned:

1 0 0 0 0 1 1 (83H in the hexadecimal form)

In addition to the modification of the code, the slave returns a byte of exception code that describes the cause of the exception. After receiving the exception response, the typical processing of the master device is to transmit the request message again or modify the command based on the fault information.

For example, to set the "Running command channel" (P00.01, the parameter address is 0001H) of the VFD whose address is 01H to 03, the command is as follows:

<u>01</u>	<u>06</u>	<u>00 01</u>	<u>00 03</u>	<u>98 0B</u>
VFD address	Write command	Parameter address	Parameter data	CRC

But the setting range of the "Running command channel" is 0 to 2. The value 3 exceeds the setting range. In this case, the VFD returns an error message response as shown in the following:

<u>01</u>	<u>86</u>	<u>04</u>	<u>43 A3</u>
VFD address	Exception response code	Error code	CRC

The exception response code 86H (generated based on the MSB "1" of the write command 06H) indicates that it is an exception response to the write command (06H). The error code is 04H. From the preceding table, we can see that it indicates the error "Operation failure", which means "The parameter is set to an invalid value in the write operation".

9.4.8 Read/Write operation example

For the formats of the read and write commands, see sections 9.4.1 and 9.4.2.

9.4.8.1 Read command 03H examples

Example 1: Read state word 1 of the VFD whose address is 01H. From the table of other function parameters, we can see that the parameter address of state word 1 of the VFD is 2100H.

The read command transmitted to the VFD is as follows:

<u>01</u>	<u>03</u>	<u>21 00</u>	<u>00 01</u>	<u>8E 36</u>
VFD address	Read command	Parameter address	Data quantity	CRC

Assume that the following response is returned:

<u>01</u>	<u>03</u>	<u>02</u>	<u>00 03</u>	<u>F8 45</u>
VFD address	Read command	Number of bytes	Data content	CRC

The data content returned by the VFD is 0003H, which indicates that the VFD is in the stopped state.

Example 2: View information about the VFD whose address is 03H, including "Type of current fault" (P07.27) to "Type of last but four fault" (P07.32) of which the parameter addresses are 071BH to 0720H (contiguous 6 parameter addresses starting from 071BH).

The command transmitted to the VFD is as follows:

<u>03</u>	<u>03</u>	<u>07 1B</u>	<u>00 06</u>	<u>B5 59</u>
VFD address	Read command	Start address	6 parameters in total	CRC

Assume that the following response is returned:

<u>03</u>	<u>03</u>	<u>0C</u>	<u>00 23</u>	<u>00 23</u>	<u>00 23</u>	<u>00 23</u>	<u>00 23</u>	<u>00 23</u>	<u>00 23</u>	<u>5F D2</u>
VFD address	Read command	Number of bytes	Type of current fault	Type of last fault	Type of last but one fault	Type of last but two fault	Type of last but three fault	Type of last but four fault		CRC

From the returned data, we can see that all the fault types are 0023H, that is, 35 in the decimal form, which means the maladjustment fault (STo)

9.4.8.2 Write command 06H examples

Example 1: Set the VFD whose address is 03H to be forward running. Refer to the table of other function parameters, the address of "Communication-based control command" is 2000H, and 0001H indicates forward running, as shown in the following figure.

Function	Address	Data description	R/W
Communication-based control command	2000H	0001H: Forward running	R/W
		0002H: Reverse running	
		0003H: Forward jogging	
		0004H: Reverse jogging	
		0005H: Stop	

Function	Address	Data description	R/W
		0006H: Coast to stop	
		0007H: Fault reset	
		0008H: Jogging to stop	

The command transmitted by the master is as follows:

03 **06** **20 00** **00 01** **42 28**
 VFD Write Parameter Forward CRC
 address command address running

If the operation is successful, the following response is returned (same as the command transmitted by the master):

03 **06** **20 00** **00 01** **42 28**
 VFD Write Parameter Forward CRC
 address command address running

Example 2: Set the "Max. output frequency" of the VFD whose address is 03H to 100 Hz.

Function code	Name	Detailed parameter description	Default value	Modify
P00.03	Max. output frequency	Used to set the max. output frequency of the VFD. It is the basis of frequency setup and the acceleration/deceleration. Setting range: Max (P00.04, 10.00) –630.00Hz	50.00Hz	⊙

From the number of decimals, we can see that the fieldbus scale of the "Max. output frequency" (P00.03) is 100. Multiply 100 Hz by 100. The value 10000 is obtained, and it is 2710H in the hexadecimal form.

The command transmitted by the master is as follows:

03 **06** **00 03** **27 10** **62 14**
 VFD Write Parameter Parameter CRC
 address command address data

If the operation is successful, the following response is returned (same as the command transmitted by the master):

03 **06** **00 03** **27 10** **62 14**
 VFD Write Parameter Parameter CRC
 address command address data

Note: In the preceding command description, spaces are added to a command just for explanatory purposes. In practical applications, no space is required in the commands.

9.4.8.3 Continuously write command 10H examples

Example 1: Set the VFD whose address is 01H to be forward running at the frequency of 10 Hz. Refer to the table of other function parameters, the address of "Communication-based control command" is 2000H, 0001H indicates forward running, and the address of "Communication-based value setting" is 2001H, as shown in the following figure. 10 Hz is 03E8H in the hexadecimal form.

Function	Address	Data description	R/W
Communication-based control command	2000H	0001H: Forward running	R/W
		0002H: Reverse running	
		0003H: Forward jogging	
		0004H: Reverse jogging	
		0005H: Stop	
		0006H: Coast to stop	
		0007H: Fault reset	
		0008H: Jogging to stop	
Communication-based value setting	2001H	Communication-based frequency setting (0–Fmax, unit: 0.01 Hz)	R/W
	2002H	PID setting, range (0–1000, 1000 corresponding to 100.0%)	

In the actual operation, set P00.01 to 2 and P00.06 to 8.

The command transmitted by the master is as follows:

01 **10** **20 00** **00 02** **04** **00 01** **03 E8** **3B 10**
VFD address Continuous write command Parameter address Parameter quantity Number of bytes Forward running 10 Hz CRC

If the operation is successful, the following response is returned:

01 **10** **20 00** **00 02** **4A 08**
VFD address Continuous write command Parameter address Parameter quantity CRC

Example 2: Set "Acceleration time" of the VFD whose address is 01H to 10s, and "Deceleration time" to 20s.

Function code	Name	Detailed parameter description	Default value	Modify
P00.11	Acceleration time 1	Setting range of P00.11 and P00.12: 0.0–3600.0s	Depends on model	<input type="radio"/>
P00.12	Deceleration time 1		Depends on model	<input type="radio"/>

The address of P00.11 is 000B, 10s is 0064H in the hexadecimal form, and 20s is 00C8H in the hexadecimal form.

The command transmitted by the master is as follows:

<u>01</u>	<u>10</u>	<u>00 0B</u>	<u>00 02</u>	<u>04</u>	<u>00 64</u>	<u>00 C8</u>	<u>F2 55</u>
VFD address	Continuous write command	Parameter address	Parameter quantity	Number of bytes	10s	20s	CRC

If the operation is successful, the following response is returned:

<u>01</u>	<u>10</u>	<u>00 0B</u>	<u>00 02</u>	<u>30 0A</u>
VFD address	Continuous write command	Parameter address	Parameter quantity	CRC

Note: In the preceding command description, spaces are added to a command just for explanatory purposes. In practical applications, no space is required in the commands.

9.4.8.4 Modbus communication commissioning example

A PC is used as the host, an RS232-RS485 converter is used for signal conversion, and the PC serial port used by the converter is COM1 (an RS232 port). The upper computer commissioning software is the serial port commissioning assistant Commix, which can be downloaded from the Internet. Download a version that can automatically execute the CRC check function. The following figure shows the interface of Commix.



First, set the serial port to **COM1**. Then, set the baud rate consistently with P14.01. The data bits, check bits, and end bits must be set consistently with P14.02. If the RTU mode is selected, you need to select the hexadecimal form **Input HEX**. To set the software to automatically execute the CRC function, you need to select **ModbusRTU**, select **CRC16 (MODBU SRTU)**, and set the start byte to 1.

After the auto CRC check function is enabled, do not enter CRC information in commands. Otherwise, command errors may occur due to repeated CRC check.

The commissioning command to set the VFD whose address is 03H to be forward running is as follows:

<u>03</u>	<u>06</u>	<u>20 00</u>	<u>00 01</u>	<u>42 28</u>
VFD address	Write command	Parameter address	Forward running	CRC

Note:

1. Set the address (P14.00) of the VFD to 03.
2. Set "Channel of running commands" (P00.01) to "Communication", and set "Communication channel of running commands" (P00.02) to the Modbus communication channel.
3. Click **Send**. If the line configuration and settings are correct, a response transmitted by the VFD is received as follows:

<u>03</u>	<u>06</u>	<u>20 00</u>	<u>00 01</u>	<u>42 28</u>
VFD address	Write command	Parameter address	Forward running	CRC

9.5 Common communication faults

Common communication faults include the following:

1. No response is returned.
2. The VFD returns an exception response.

Possible causes of no response include the following:

1. The serial port is set incorrectly. For example, the converter uses the serial port COM1, but COM2 is selected for the communication.
2. The settings of the baud rates, data bits, end bits, and check bits are inconsistent with those set on the VFD.
3. The positive pole (+) and negative pole (-) of the RS485 bus are connected reversely.
4. The resistor connected to 485 terminals on the terminal block of the VFD is set incorrectly.

Appendix A Extension cards

A.1 Model definition

EC-PG 5 01-05

① ② ③ ④ ⑤

Field identifier	Field description	Naming example
①	Product category	EC: Extension card
②	Card category	PG: PG card PC: PLC programmable card IO: IO extension card TX: Communication extension card
③	Technical version	Indicates the generation of a technical version by using odd numbers, for example, 1, 3, and 5 indicate the 1 st , 2 nd , and 3 rd generations of the technical version.
④	Distinguishing code	01: Incremental PG card + frequency-divide output
		02: Sine/Cosine PG card + pulse direction setting + frequency-divide output
		03: UVW PG interface + pulse direction setting + frequency-divide output
		04: Resolver PG interface + pulse direction setting + frequency-divide output
		05: Incremental PG card + pulse direction setting + frequency-divide output
		06: Absolute PG interface + pulse direction setting + frequency-divide output
		07: Reserved 2
⑤	Working power	00: Passive
		05: 5V
		12: 12–15 V
		24: 24 V

EC-PC 5 01-00

- ① ② ③ ④ ⑤

Field identifier	Field description	Naming example
①	Product category	EC: Extension card
②	Card category	IO: IO extension card TX: Communication extension card PG: PG card PC: PLC programmable card
③	Technical version	Indicates the generation of a technical version by using odd numbers, for example, 1, 3, and 5 indicate the 1 st , 2 nd , and 3 rd generations of the technical version.
④	Distinguishing code	01: 10 points, 6 inputs and 4 outputs (2 transistor outputs + 2 relay outputs) 02: 14 points, 8 inputs and 6 outputs (relay outputs) 03: Reserved
⑤	Special requirement	Reserved

EC-TX 5 01

- ① ② ③ ④

Field identifier	Field description	Naming example
①	Product category	EC: Extension card
②	Card category	TX: Communication extension card PG: PG card PC: PLC programmable card IO: IO extension card
③	Technical version	Indicates the generation of a technical version by using odd numbers, for example, 1, 3, and 5 indicate the 1 st , 2 nd , and 3 rd generations of the technical version.
④	Distinguishing code	01: Bluetooth communication card 02: WIFI communication card 03: PROFIBUS communication card

Field identifier	Field description	Naming example
		04: Ethernet communication card
		05: Canopen communication card
		06: DeviceNet communication card
		07: BACnet communication card
		08: EtherCAT communication card
		09: PROFINET communication card
		10: 485 communication card
		11: CAN master/slave control communication card

EC-IO 5 01-00

① ② ③ ④ ⑤

Field identifier	Field description	Naming example
①	Product category	EC: Extension card
②	Card category	IO: I/O extension card TX: Communication extension card PG: PG card PC: PLC programmable card
③	Technical version	Indicates the generation of a technical version by using odd numbers, for example, 1, 3, and 5 indicate the 1 st , 2 nd , and 3 rd generations of the technical version.
④	Distinguishing code	01: Multiple-function I/O extension card (4 digital inputs, 1 digital output, 1 analog input, 1 analog output, and 2 relay outputs)
		02: Digital I/O card
		03: Analog I/O card
		04: Reserved 1
		05: Reserved 2
⑤	Special requirement	

The following table describes extension cards that Goodrive350 IP54 high-ingress protection series VFDs support. The extension cards are optional and need to be purchased separately.

Name	Model	Specification
IO extension card	EC-IO501-00	<ul style="list-style-type: none"> ◇ 4 digital inputs ◇ 1 digital output ◇ 1 analog input ◇ 1 analog output ◇ 2 relay outputs: 1 double-contact output, and 1 single-contact output
Programmable extension card	EC-PC501-00	<ul style="list-style-type: none"> ◇ Adopting the global mainstream development environment, supporting multiple types of programming languages, such as the instruction language, structural text, function block diagram, ladder diagram, continuous function chart, and sequential function chart ◇ Supporting breakpoint commissioning ◇ Providing user program storage space of 128 kB, and data storage space of 64 kB ◇ 6 digital inputs ◇ 2 digital outputs ◇ 2 relay outputs: 1 double-contact output, and 1 single-contact output
Bluetooth communication card	EC-TX501-1 EC- TX501-2	<ul style="list-style-type: none"> ◇ Supporting Bluetooth 4.0 ◇ With INVT's mobile phone APP, you can set the parameters and monitor the states of the VFD through Bluetooth ◇ The maximum communication distance in open environments is 30 m. ◇ EC-TX501-1 is equipped with a built-in antenna and applicable to molded case machines. ◇ EC-TX501-2 is configured with an external sucker antenna and applicable to sheetmetal machines.
WIFI communication card	EC-TX502-1 EC-TX502-2	<ul style="list-style-type: none"> ◇ Meeting IEEE802.11b/g/n ◇ With INVT's mobile phone APP, you can monitor the VFD locally or remotely through WIFI communication ◇ The maximum communication distance in open environments is 30 m. ◇ EC-TX501-1 is equipped with a built-in antenna and applicable to molded case machines. ◇ EC-TX501-2 is configured with an external sucker antenna and applicable to sheetmetal machines.
PROFIBUS-DP communication card	EC-TX503	<ul style="list-style-type: none"> ◇ Supporting the PROFIBUS-DP protocol

Name	Model	Specification
Ethernet communication card	EC-TX504	<ul style="list-style-type: none"> ◇ Supporting Ethernet communication with INVT's internal protocol ◇ Can be used in combination with INVT's upper computer monitoring software INVT Studio
CANopen communication card	EC-TX505	<ul style="list-style-type: none"> ◇ Based on the CAN2.0A physical layer ◇ Supporting the CANopen protocol
CAN master/slave control communication card	EC-TX511	<ul style="list-style-type: none"> ◇ Based on the CAN2.0B physical layer ◇ Adopting INVT's master-slave control proprietary protocol
PROFINET communication card	EC-TX509	<ul style="list-style-type: none"> ◇ Supporting the PROFINET protocol
UVW incremental PG card	EC-PG503-05	<ul style="list-style-type: none"> ◇ Applicable to differential encoders of 5 V ◇ Supporting the orthogonal input of A, B, and Z ◇ Supporting pulse input of phase U, V, and W ◇ Supporting the frequency-divided output of A, B, and Z ◇ Supporting the input of pulse string reference
Resolver PG card	EC-PG504-00	<ul style="list-style-type: none"> ◇ Applicable to resolver encoders ◇ Supporting frequency-divided output of resolver-simulated A, B, Z
Multi-function incremental PG card	EC-PG505-12	<ul style="list-style-type: none"> ◇ Applicable to OC encoders of 5 V or 12 V ◇ Applicable to push-pull encoders of 5 V or 12 V ◇ Applicable to differential encoders of 5 V ◇ Supporting the orthogonal input of A, B, and Z ◇ Supporting the frequency-divided output of A, B, and Z ◇ Supporting pulse string setting



IO extension card
EC-IO501-00



PrPogrammable
extension card
EC-PC501-00



Bluetooth
communication card
EC-TX501/502



PROFIBUS-DP
communication card
EC-TX503



Ethernet
communication card



CANopen/CAN
communication card
EC-TX505/511



PROFINET
communication card
EC-TX509



UWV incremental PG
card EC-PG503-05



Resolver PG card
EC-PG504-00



Multi-function
incremental PG card
EC-PG505-12

A.2 Dimensions and installation

All extension cards are of the same dimensions (108 mm × 39 mm) and can be installed in the same way.

Following the following operation principles when installing or removing an extension card:

1. Ensure that no power is applied before installing the extension card.
2. The extension card can be installed in any one of the SLOT1, SLOT2, and SLOT3 card slots.
3. VFDs of 05R5G/7R5P or below can be configured with two extension cards, VFDs of 7R5G/011P or higher can be configured with three extension cards.
4. If interference occurs on the external wires after extension cards are installed, change their installation card slots flexibly to facilitate the wiring. For example, the connector of the connection cable of the DP card is large, so it is recommended to be installed in the SLOT1 card slot.

Figure A-1 shows the installation diagram and a VFD with extension cards installed.

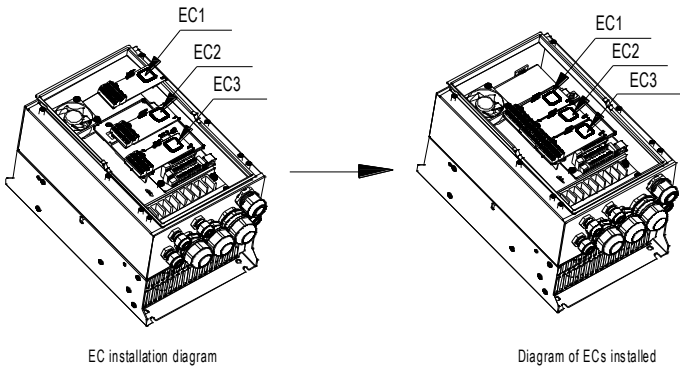

Figure A-1 VFD of 7R5G/011P or higher with extension cards installed

Extension card installation process:

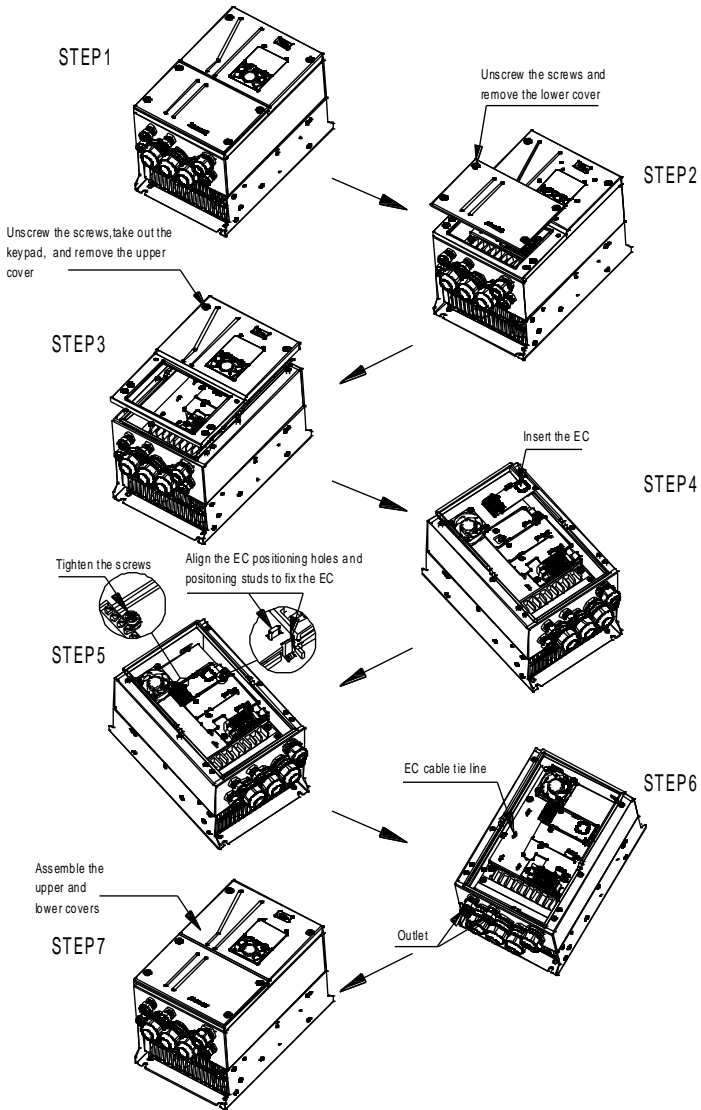

Figure A-2 Extension card installation process diagram

A.3 Wiring

1. Ground a shielded cable as follows:

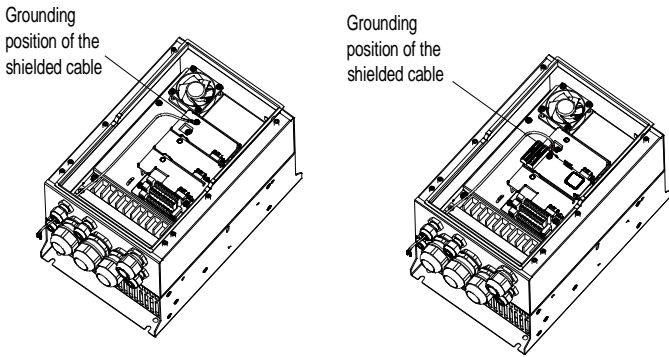

Figure A-3 Extension card grounding diagram

2. Wire an extension card as follows:

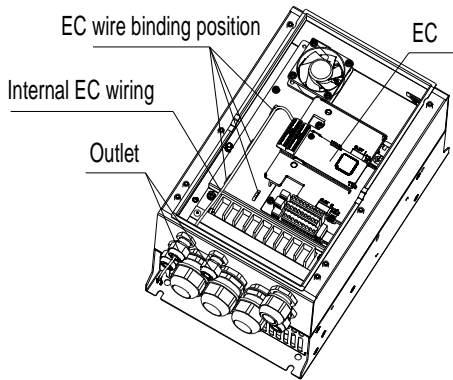
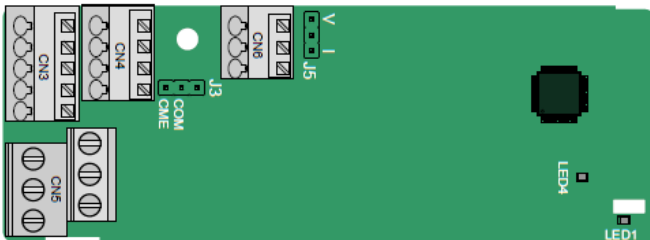

Figure A-4 Extension card wiring

A.4 I/O extension card (EC-IO501-00) function description



The terminals are arranged as follows:

CME and COM are shorted through J3 before delivery, and J5 is the jumper for selecting the output type (voltage or current) of AO2.

AI3	AO2	GND
-----	-----	-----

COM	CME	Y2	S5	
PW	+24V	S6	S7	S8

RO3A	RO3B	RO3C
RO4A		RO4C

Indicator definition

Indicator No.	Definition	Function
LED1	State indicator	This indicator is on when the extension card is establishing a connection with the control board; it blinks periodically after the extension card is properly connected to the control board (the period is 1s, on for 0.5s, and off for the other 0.5s); and it is off when the extension card is disconnected from the control board.
LED4	Power indicator	This indicator is on after the IO extension card is powered on by the control board.

The EC-IO501-00 extension card can be used in scenarios where the I/O interfaces of a Goodrive350 IP54 high-ingress protection series VFD cannot meet the application requirements. It can provide 4 digital inputs, 1 digital output, 1 analog input, 1 analog output, and two relay outputs. It is user-friendly, providing relay outputs through European-type screw terminals and other inputs and outputs through spring terminals.

EC-IO501-00 terminal function description

Category	Label	Name	Function description
Power	PW	External power supply	The working power of digital input is provided by an external power supply. Voltage range: 12–30 V The terminals PW and +24V are shorted before delivery.
Analog input/output	AI3—GND	Analog input 1	1. Input range: 0–10 V, 0–20 mA 2. Input impedance: 20 kΩ for voltage input; 250 Ω for current input 3. Set it to be voltage or current input through the corresponding function code. 4. Resolution: When 10 V corresponds to

Category	Label	Name	Function description
			50 Hz, the minimum resolution is 5 mV. 5. Deviation:±0.5%; input of 5 V or 10 mA or higher at the temperature of 25°C
	AO2—GND	Analog output 1	1. Output range: 0–10 V, 0–20 mA 2. Whether it is voltage or current output is determined by J5. 3. Deviation ±0.5%; input of 5 V or 10 mA or higher at the temperature of 25°C
Digital input/output	S5—COM	Digital input 1	1. Internal impedance: 3.3 kΩ 2. Power input range: 12–30 V 3. Bidirectional input terminal 4. Max. input frequency: 1 kHz
	S6—COM	Digital input 2	
	S7—COM	Digital input 3	
	S8—COM	Digital input 4	
	Y2—CME	Digital output	1. Switch capacity: 50mA/30 V 2. Output frequency range: 0–1 kHz 3. The terminals CME and COM are shorted through J3 before delivery.
Relay output	RO3A	NO contact of relay 3	1. Contact capacity: 3A/AC 250 V, 1 A/DC 30 V 2. Do not use them as high-frequency digital outputs.
	RO3B	NC contact of relay 3	
	RO3C	Common contact of relay 3	
	RO4A	NO contact of relay 4	
	RO4C	Common contact of relay 4	

A.5 Programmable extension card (EC-PC501-00) function description

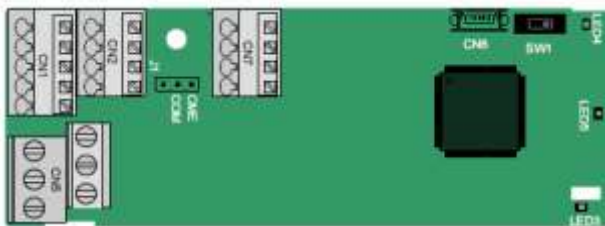

The terminals are arranged as follows:

SW1 is the start/stop switch of the programmable extension card. CN6 is the program download port,

and you can connect to a computer by using a standard USB cable. COM and CME are shorted through J1 before delivery.

PY1	PY2	CME	COM
-----	-----	-----	-----

COM	PS1	PS2	PS3	
PW	+24V	PS4	PS5	PS6

PRO1A	PRO1B	PRO1C
PRO2A		PRO2C

Indicator definition

Indicator No.	Definition	Function
LED3	State indicator	This indicator is on when the extension card is establishing a connection with the control board; it blinks periodically after the extension card is properly connected to the control board (the period is 1s, on for 0.5s, and off for the other 0.5s); and it is off when the extension card is disconnected from the control board.
LED4	PLC running state indicator	This indicator is on when the DIP switch is turned to RUN (run the PLC); and it is off when the switch is turned to STOP (stop the PLC).
LED5	Power indicator	This indicator is on after the control board feeds power to the communication card.

The EC-PC501-00 programmable extension card can replace some micro PLC applications. It adopts the global mainstream development environment, supporting six types of programming languages, namely the instruction language (IL), structural text (ST), function block diagram (FBD), ladder diagram (LD), continuous function chart (CFC), and sequential function chart (SFC). It provides a user program storage space of 128 kB and data storage space of 64 kB, which facilitates customers' secondary development and meets the customization requirements.

The EC-PC501-00 programmable extension card provides 6 digital inputs, 2 digital outputs, and 2 relay outputs. It is user-friendly, providing relay outputs through European-type screw terminals and other inputs and outputs through spring terminals.

EC-PC501-00 terminal function description

Category	Label	Name	Function description
Power	PW	External power	The working power of digital input is provided by an external power supply. Voltage range: 12–30 V The terminals PW and +24V are shorted before delivery.
Digital input/output	PS1—COM	Digital input 1	1. Internal impedance: 3.3 kΩ 2. Allowable voltage input: 12–30 V
	PS2—COM	Digital input 2	

Category	Label	Name	Function description
	PS3—COM	Digital input 3	3. Bidirectional terminal 4. Max. input frequency: 1 kHz
	PS4—COM	Digital input 4	
	PS5—COM	Digital input 5	
	PS6—COM	Digital input 6	
	PY1—CME	Digital output 1	1. Switch capacity: 50 mA/30 V 2. Output frequency range: 0–1 kHz 3. The terminals CME and COM are shorted through J1 before delivery.
PY2—CME	Digital output 2		
Relay output	PRO1A	NO contact of relay 1	1. Contact capacity: 3A/AC 250 V, 1 A/DC 30 V 2. Do not use them as high-frequency digital outputs.
	PRO1B	NC contact of relay 1	
	PRO1C	Common contact of relay 1	
	PRO2A	NO contact of relay 2	
	PRO2C	Common contact of relay 2	

For details about the operation of programmable extension cards, see the *Goodrive350 Series VFD Communication Extension Card Operation Manual*.

A.6 Communication card function description

A.6.1 Bluetooth communication card

EC-TX501 and WIFI communication card—EC- TX502

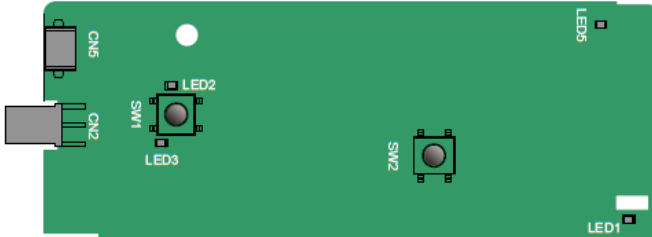

Definitions of indicators and function buttons:

Indicator No.	Definition	Function
LED1/LED3	Bluetooth/WIFI state indicator	LED is on when the extension card is establishing a connection with the control board; LED blinks periodically after the extension card is properly connected to the control board (the period is 1s, on for 0.5s, and off for the other 0.5s); and LED is off when the extension card is disconnected from the control board.
LED2	Bluetooth communication state indicator	This indicator is on when Bluetooth communication is online and data exchange can be performed. It is off when Bluetooth communication is not in the online state.
LED5	Power indicator	This indicator is on after the control board feeds power to the Bluetooth card.
SW1	WIFI factory reset button	It is restored to default values and returned to the local monitoring mode.
SW2	WIFI hardware reset button	It is used to reboot the extension card.

The wireless communication card is especially useful for scenarios where you cannot directly use the keypad to operate the VFD due to the restriction of the installation space. With a mobile phone APP, you can operate the VFD in a maximum distance of 30 m. You can choose a PCB antenna or an external sucker antenna. If the VFD is located in an open space and is a molded case machine, you can use a built-in PCB antenna; and if it is a sheetmetal machine and located in a metal cabinet, you need to use an external sucker antenna.

When installing a sucker antenna, install a wireless communication card on the VFD first, and then lead the SMA connector of the sucker antenna into the VFD and screw it to CN2, as shown in the

following figure. Place the antenna base on the chassis and expose the upper part. Try to keep it unblocked.

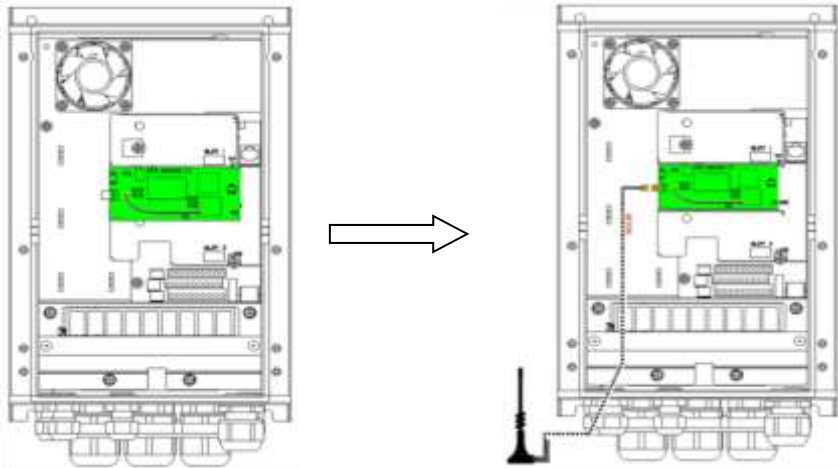

The wireless communication card must be used with the INVT VFD APP. Scan the QR code of the VFD nameplate to download it. For details, refer to the wireless communication card manual provided with the extension card. The main interface is shown as follows.

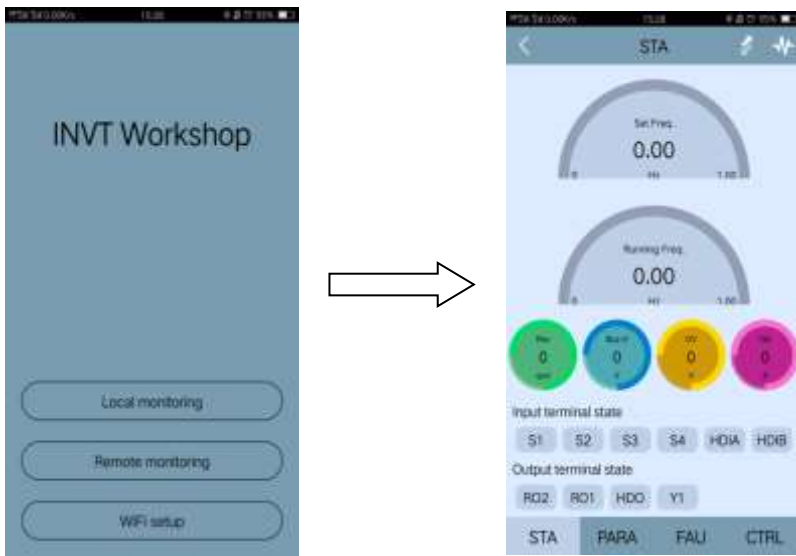

A.6.2 PROFIBUS-DP communication card
 EC-TX503

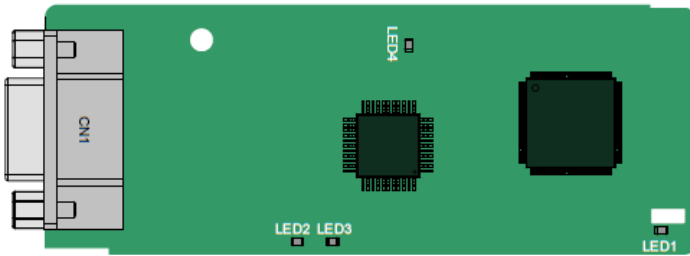

CN1 is a 9-pin D-type connector, as shown in the following figure.

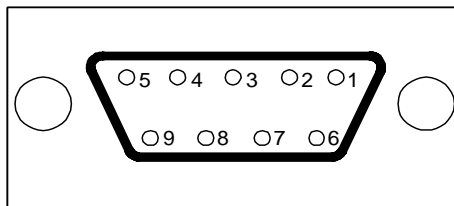

Connector pin		Description
1	-	Unused
2	-	Unused
3	B-Line	Data+ (twisted pair 1)
4	RTS	Request sending
5	GND_BUS	Isolation ground
6	+5V BUS	Isolated power supply of 5 V DC
7	-	Unused
8	A-Line	Data- (twisted pair 2)
9	-	Unused
Housing	SHLD	PROFIBUS cable shielding line

+5V and GND_BUS are bus terminators. Some devices, such as the optical transceiver (RS485), may need to obtain power through these pins.

On some devices, the transmission and receiving directions are determined by RTS. In normal applications, only A-Line, B-Line, and the shield layer need to be used.

Indicator definition

Indicator No.	Definition	Function
LED1	State indicator	This indicator is on when the extension card is establishing a connection with the control board; it blinks periodically after the extension card is

Indicator No.	Definition	Function
		properly connected to the control board (the period is 1s, on for 0.5s, and off for the other 0.5s); and it is off when the extension card is disconnected from the control board.
LED2	Online indicator	This indicator is on when the communication card is online and data exchange can be performed. It is off when the communication card is not in the online state.
LED3	Offline/Fault indicator	This indicator is on when the communication card is offline and data exchange cannot be performed. It blinks when the communication card is not in the offline state. It blinks at the frequency of 1 Hz when a configuration error occurs: The length of the user parameter data set during the initialization of the communication card is different from that during the network configuration. It blinks at the frequency of 2 Hz when user parameter data is incorrect: The length or content of the user parameter data set during the initialization of the communication card is different from that during the network configuration. It blinks at the frequency of 4 Hz when an error occurs in the ASIC initialization of PROFIBUS communication. It is off when the diagnosis function is disabled.
LED4	Power indicator	This indicator is on after the control board feeds power to the communication card.

For details about the operation, see the *Goodrive350 Series VFD Communication Extension Card Operation Manual*.

A.6.3 Ethernet communication card

EC-TX504

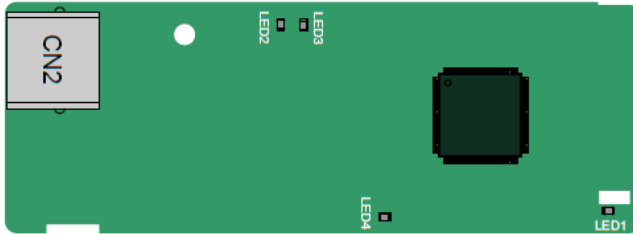

The EC-TX504 communication card adopts standard RJ45 terminals.

Indicator definition

Indicator No.	Definition	Function
LED1	State indicator	This indicator is on when the extension card is establishing a connection with the control board; it blinks periodically after the extension card is properly connected to the control board (the period is 1s, on for 0.5s, and off for the other 0.5s); and it is off when the extension card is disconnected from the control board.
LED4	Power indicator	This indicator is on after the control board feeds power to the communication card.

A.6.4 CANopen communication card

EC-TX505 and CAN master/slave control communication card EC- TX511

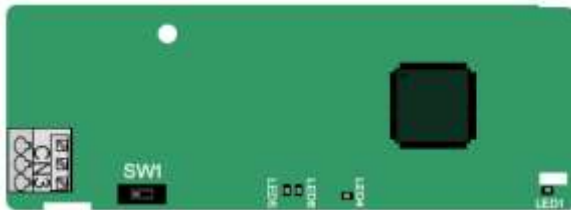

The EC-TX505 communication card is user-friendly, adopting spring terminals.

3-pin spring terminal	Pin	Function	Description
	1	CANH	CANopen bus high level signal
	2	CANG	CANopen bus shielding
	3	CANL	CANopen bus low level signal

Terminal resistor switch function description

Terminal resistor switch	Position	Function	Description
	Left	OFF	CAN_H and CAN_L are not connected to a terminal resistor.
	Right	ON	CAN_H and CAN_L are connected to a terminal resistor of 120 Ω.

Indicator definition

Indicator No.	Definition	Function
LED1	State indicator	This indicator is on when the extension card is establishing a connection with the control board; it blinks periodically after the extension card is properly connected to the control board (the period is 1s, on for 0.5s, and off for the other 0.5s); and it is off when the extension card is disconnected from the control board.
LED4	Power indicator	This indicator is on after the control board feeds power to the communication card.
LED5	Running indicator	This indicator is on when the communication card is in the working state. It is off when a fault occurs. Check whether the reset pin of the communication card and the power supply are properly connected. It blinks when the communication card is in the pre-operation state. It blinks once when the communication card is in the stopped state.
LED6	Error indicator	This indicator is on when the CAN controller bus is off or a fault occurs on the VFD. It is off when the communication card is in the working state. It blinks when the address setting is incorrect. It blinks once when a received frame is missed or an error occurs during frame receiving.

For details about the operation, see the *Goodrive350 Series VFD Communication Extension Card Operation Manual*.

A.6.5 PROFINET communication card

EC- TX509

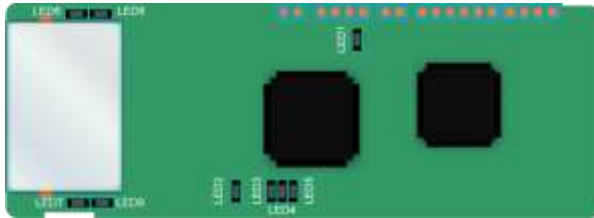

The terminal CN2 adopts a standard RJ45 interface, where CN2 is the dual RJ45 interface, and these two RJ45 interfaces are not distinguished from each other and can be interchangeably inserted. They are arranged as follows:

Pin	Name	Description
1	n/c	Not connected
2	n/c	Not connected
3	RX-	Receive Data-
4	n/c	Not connected
5	n/c	Not connected
6	RX+	Receive Data+
7	TX-	Transmit Data-
8	TX+	Transmit Data+

Definition of the state indicator

The PROFINET communication card has 9 indicators, of which LED1 is the power indicator, LED2–5 are the communication state indicator of the communication card, and LED6–9 are the state indicators of the network port.

LED	Color	State	Description
LED1	Green	/	3.3V power indicator
LED2 (Bus state indicator)	Red	On	No network connection
		Blinking	The connection to the network cable between the PROFINET controller is OK, but the communication is not established.
		Off	Communication with the PROFINET controller has been established
LED3 (System fault indicator)	Green	On	PROFINET diagnosis exists
		Off	No PROFINET diagnosis
LED4 (Slave ready indicator)	Green	On	TPS-1 protocol stack has started
		Blinking	TPS-1 waits for MCU initialization
		Off	TPS-1 protocol stack does not start

LED	Color	State	Description
LED5 (Maintenance state indicator)	Green	/	Manufacturer-specific—depending on the characteristics of the device
LED6/7 (Network port state indicator)	Green	On	PROFINET communication card and PC/PLC have been connected via a network cable
		Off	PROFINET communication card and PC/PLC have not been connected yet
LED8/9 (Network port communication indicator)	Green	Blinking	PROFINET communication card and PC/PLC are communicating
		Off	PROFINET communication card and PC/PLC are not yet communicating

Electrical connection:

The PROFINET communication card adopts a standard RJ45 interface, which can be used in a linear network topology and a star network topology. The linear network topology electrical connection diagram is shown below.

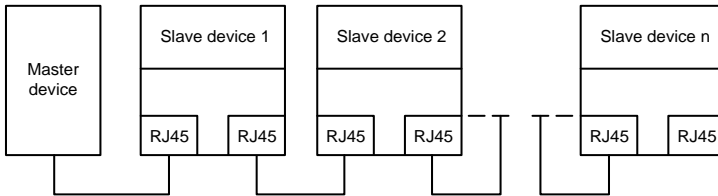

Linear network topology electrical connection diagram

Note: For the star network topology, users need to prepare PROFINET switches.

The star network topology electrical connection diagram is shown below:

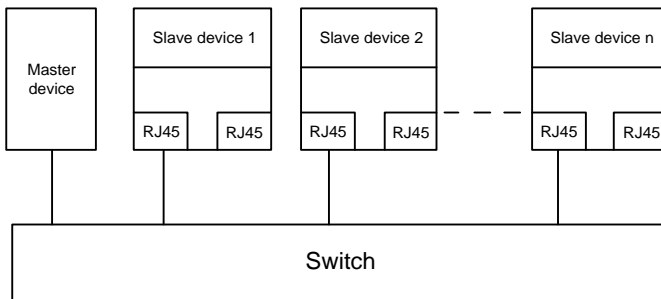

A.7 PG extension card function description

A.7.1 UVW incremental PG card—EC-PG503-05

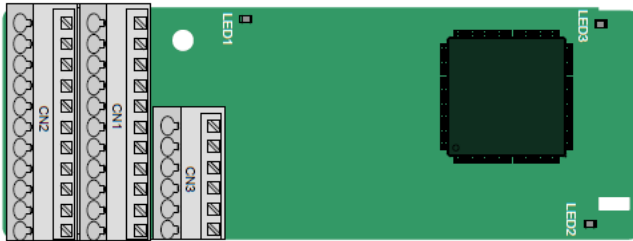

The terminals are arranged as follows:

					A2+	A2-	B2+	B2-	Z2+	Z2-
PE	AO+	BO+	ZO+	A1+	B1+	Z1+	U+	V+	W+	PWR
GND	AO-	BO-	ZO-	A1-	B1-	Z1-	U-	V-	W-	PGND

Indicator definition

Indicator No.	Definition	Function
LED1	Disconnection indicator	This indicator is off when A1 and B1 of the encoder are disconnected; and it is on when the pulses are normal.
LED2	State indicator	This indicator is on when the extension card is establishing a connection with the control board; it blinks periodically after the extension card is properly connected to the control board (the period is 1s, on for 0.5s, and off for the other 0.5s); and it is off when the extension card is disconnected from the control board.
LED3	Power indicator	This indicator is on after the control board feeds power to the PG card.

The EC-PG503-05 extension card supports the input of absolute position signals and integrates the advantages of absolute and incremental encoders. It is user-friendly, adopting spring terminals.

EC-PG503-05 terminal function description

Label	Name	Function description
PE	Grounding terminal	It is connected to the ground for enhancing the anti-interference performance
GND	Ground	PCB internal power ground
PWR	Encoder power	Voltage: 5 V±5% Max. current: 200 mA (PGND is isolation power ground)
PGND		

Label	Name	Function description
A1+	Encoder interface	1. Differential incremental PG interface of 5 V 2. Response frequency: 400 kHz
A1-		
B1+		
B1-		
Z1+		
Z1-		
A2+	Pulse setting	1. Differential input of 5 V 2. Response frequency: 200 kHz
A2-		
B2+		
B2-		
Z2+		
Z2-		
AO+	Frequency-divided output	1. Differential output of 5 V 2. Supporting frequency division of 1–255, which can be set through P20.16 or P24.16
AO-		
BO+		
BO-		
ZO+		
ZO-		
U+	UVW encoder interface	1. Absolute position (UVW information) of the hybrid encoder, differential input of 5 V 2. Response frequency: 40 kHz
U-		
V+		
V-		
W+		
W-		

The following figure shows the external wiring of the EC-PG503-05 extension card.

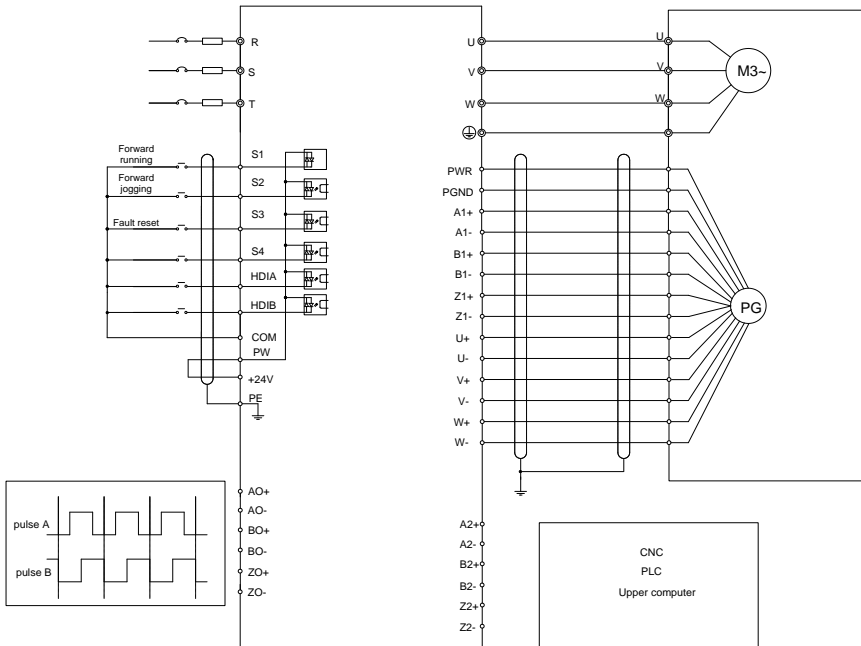

A.7.2 Resolver PG card—EC-PG504-00



PE	AO+	BO+	ZO+	EX+	SI+	CO+	A2+	B2+	Z2+	PWR
GND	AO-	BO-	ZO-	EX-	SI-	CO-	A2-	B2-	Z2-	GND

Indicator definition

Indicator No.	Definition	Function
LED1	State indicator	This indicator is on when the extension card is establishing a connection with the control board; it blinks periodically after the extension card is properly connected to the control board (the

Indicator No.	Definition	Function
		period is 1s, on for 0.5s, and off for the other 0.5s); and it is off when the extension card is disconnected from the control board.
LED2	Disconnection indicator	This indicator is off when the encoder is disconnected; it is on when the encoder signals are normal; and it blinks when the encoder signals are not stable.
LED3	Power indicator	This indicator is on after the control board feeds power to the PG card.

The EC-PG504-00 extension card can be used in combination with a resolver of excitation voltage 7 Vrms. It is user-friendly, adopting spring terminals.

EC-PG504-00 terminal function description

Label	Name	Function description
PE	Grounding terminal	It is connected to the ground for enhancing the anti-interference performance
PWR	Output power supply	Voltage 5V±5%
GND		
SI+	Encoder signal input	Recommended resolver transformation ratio: 0.5
SI-		
CO+		
CO-		
EX+	Encoder excitation signal	1. Factory setting of excitation: 10 kHz 2. Supporting resolvers with an excitation voltage of 7 Vrms
EX-		
A2+	Pulse setting	1. Differential input of 5 V 2. Response frequency: 200 kHz
A2-		
B2+		
B2-		
Z2+		
Z2-		
AO+	Frequency-divided output	1. Differential output of 5 V 2. Frequency-divided output of resolver simulated A1, B1, and Z1, which is equal to an incremental PG card of 1024 pps. 3. Supporting frequency division of 1–255, which can be set through P20.16 or P24.16 4. Max. output frequency: 200 kHz
AO-		
BO+		
BO-		
ZO+		
ZO-		

The following figure shows the external wiring of the EC-PG504-00 extension card.

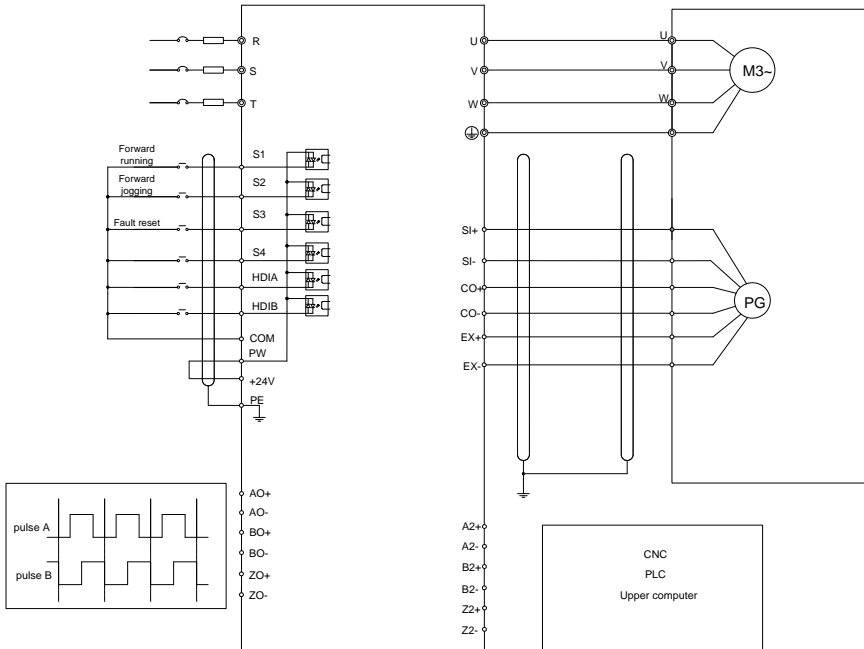

A.7.3 Multi-function incremental PG card—EC-PG505-12



The terminals are arranged as follows:

The dual in-line package (DIP) switch SW1 is used to set the voltage class (5 V or 12 V) of the power supply of the encoder. The DIP switch can be operated with an auxiliary tool.

PE	AO+	BO+	ZO+	A1+	B1+	Z1+	A2+	B2+	Z2+	PWR
GND	AO-	BO-	ZO-	A1-	B1-	Z1-	A2-	B2-	Z2-	PGND

Indicator definition

Indicator No.	Definition	Function
LED1	State indicator	This indicator is on when the extension card is establishing a connection with the control board; it blinks periodically after the extension card is properly connected to the control board (the period is 1s, on for 0.5s, and off for the other 0.5s); and it is off when the extension card is disconnected from the control board.
LED2	Disconnection indicator	This indicator is off when A1 and B1 of the encoder is disconnected; and it is on when the pulses are normal.
LED3	Power indicator	This indicator is on after the control board feeds power to the PG card.

The EC-PG505-12 extension card can be used in combination with multiple types of incremental encoders through different modes of wiring. It is user-friendly, adopting spring terminals.

EC-PG505-12 terminal function description

Label	Name	Function description
PE	Grounding terminal	It is connected to the ground for enhancing the anti-interference performance
GND	Ground	PCB internal power ground
PWR	Encoder power	Voltage: 5 V/12 V \pm 5% Max. output: 150 mA Select the voltage class through the DIP switch SW1 based on the voltage class of the used encoder. (PGND is isolation power ground)
PGND		
A1+	Encoder interface	<ol style="list-style-type: none"> Supporting push-pull interfaces of 5 V/12 V Supporting open collector interfaces of 5 V/12 V Supporting differential interfaces of 5 V Response frequency: 200 kHz
A1-		
B1+		
B1-		
Z1+		
Z1-		
A2+	Pulse setting	<ol style="list-style-type: none"> Supporting the same signal types as the encoder signal types Response frequency: 200 kHz
A2-		
B2+		
B2-		
Z2+		
Z2-		

Label	Name	Function description
AO+	Frequency-divided output	1. Differential output of 5 V 2. Supporting frequency division of 1–255, which can be set through P20.16 or P24.16
AO-		
BO+		
BO-		
ZO+		
ZO-		

The following figure shows the external wiring of the extension card used in combination with an open collector encoder. A pull-up resistor is configured inside the PG card.

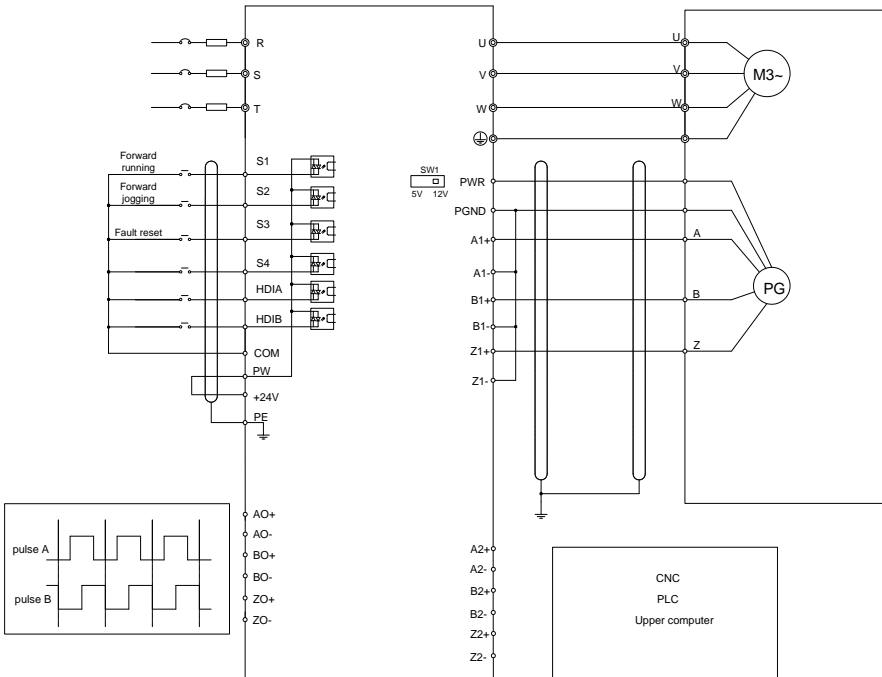

The following figure shows the external wiring of the extension card used in combination with a push-pull encoder.

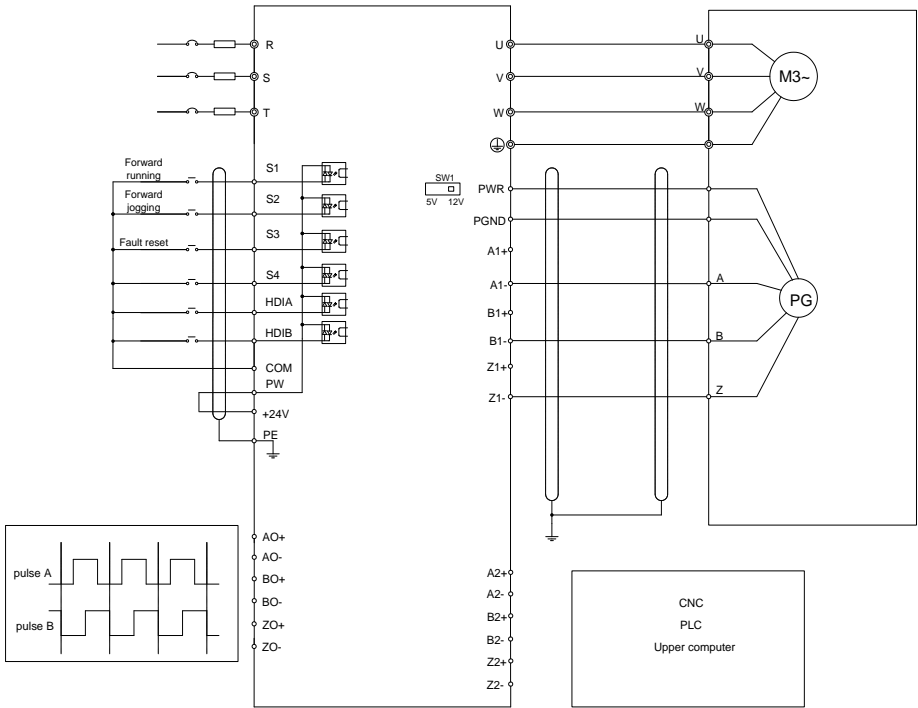

The following figure shows the external wiring of the extension card used in combination with a differential encoder.

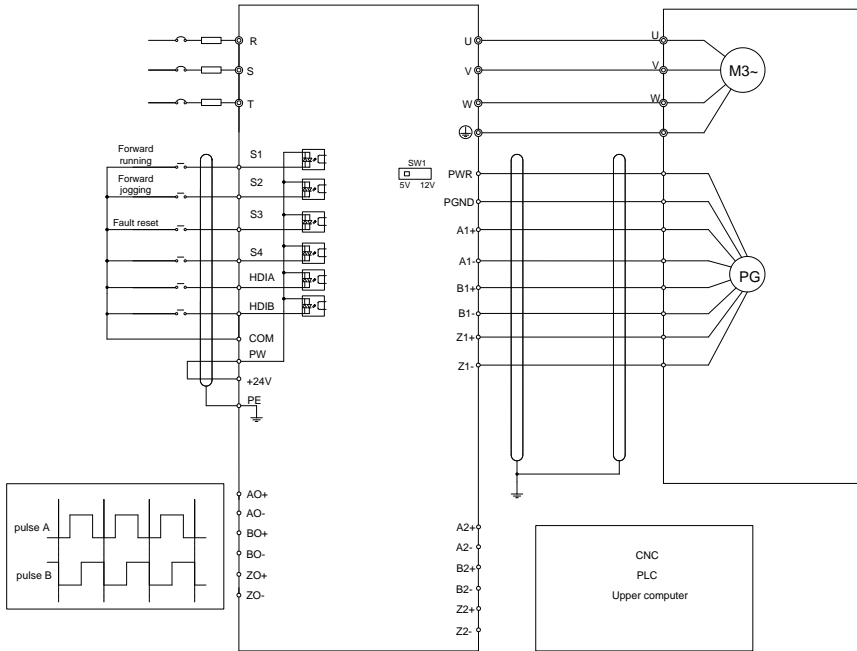

Appendix B Technical data

B.1 What this chapter contains

This chapter describes the technical data of the VFD and its compliance to CE and other quality certification systems.

B.2 Derated application

B.2.1 Capacity

Choose a VFD based on the rated current and power of the motor. To endure the rated power of the motor, the rated output current of the VFD must be larger or equal to the rated current of the motor. The rated power of the VFD must be higher or equal to that of the motor.

Note:

1. The maximum allowable shaft power of the motor is limited to 1.5 times the rated power of the motor. If the limit is exceeded, the VFD automatically restricts the torque and current of the motor. This function effectively protect the input shaft against overload.
2. The rated capacity is the capacity at the ambient temperature of 40°C.
3. You need to check and ensure that the power flowing through the common DC connection in the common DC system does not exceed the rated power of the motor.

B.2.2 Derating

If the ambient temperature on the site where the VFD is installed exceeds 40°C, the altitude exceeds 1000 m, the heat emission hole coverplate is used, or the carrier frequency is greater than the recommended frequency in the manual (see function code P00.14 for the recommended frequency), the VFD needs to be derated.

B.2.2.1 Derating due to temperature

When the temperature ranges from +40°C to +50°C, the rated output current is derated by 1% for each increased 1°C. For the actual derating, see the following figure.

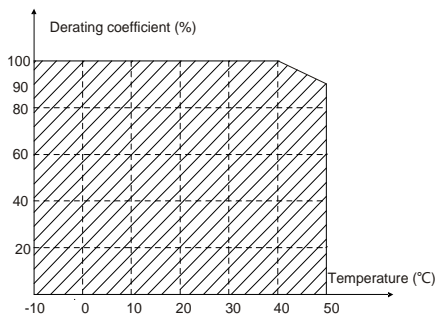

Fig B.1 Diagram of actual temperature derating

Note: It is not recommended to use the VFD at a temperature higher than 50°C. If you do, you shall be held accountable for the consequences caused.

B.2.2.2 Derating due to altitude

When the altitude of the site where the VFD is installed is lower than 1000 m, the VFD can run at the rated power. When the altitude exceeds 1000m, derate 1% for every additional 100m. When the installation site altitude exceeds 3000m, consult the local INVT dealer or office.

B.2.2.3 Derating due to carrier frequency

The power of Goodrive350 IP54 high-ingress protection series VFDs varies according to carrier frequencies. The rated power of a VFD is defined based on the carrier frequency set in factory. If the carrier frequency exceeds the factory setting, the power of the VFD is derated by 10% for each increased 1 kHz.

B.3 Grid specifications

Grid voltage	AC 3PH 380V (-15%)–440V (+10%) AC 3PH 520V (-15%)–690V (+10%)
Short-circuit capacity	According to the definition in IEC 60439-1, the maximum allowable short-circuit current at the incoming end is 100 kA. Therefore, the VFD is applicable to scenarios where the transmitted current in the circuit is no larger than 100 kA when the VFD runs at the maximum rated voltage.
Frequency	50/60 Hz±5%, with a maximum change rate of 20%/s

B.4 Motor connection data

Motor type	asynchronous induction motor or permanent-magnet synchronous motor
Voltage	0–U1 (rated voltage of the motor), 3PH symmetrical, Umax (rated voltage of the VFD) at the field-weakening point
Short-circuit protection	The short-circuit protection for the motor output meets the requirements of IEC 61800-5-1.
Frequency	0–400 Hz
Frequency resolution	0.01 Hz
Current	See section 3.6 Rated values.
Power limit	1.5 times of the rated power of the motor
Field-weakening point	10–400 Hz
Carrier frequency	4, 8, 12, or 15 kHz

B.4.1 EMC compatibility and motor cable length

The following table describes the maximum motor cable lengths that meet the requirements of the EU EMC directive (2014/30/EU).

All models (with external EMC filters)	Maximum motor cable length (m)
Environment category II (C3)	30

You can learn the maximum length of the motor cable through the running parameters of the VFD. To understand the accurate maximum cable length for using an external EMC filter, contact the local INVT office.

For description about the environments categories II (C3), see section B.6 "EMC regulations".

B.5 Application standards

The following table describes the standards that the VFDs comply with.

EN/ISO 13849-1	Safety of machinery—Safety-related parts of control systems—Part 1: General principles for design
IEC/EN 60204-1	Safety of machinery—Electrical equipment of machines. Part 1: General requirements
IEC/EN 62061	Safety of machinery—Safety-related functional safety of electrical, electronic, and programmable electronic control systems
IEC/EN 61800-3	Adjustable speed electrical power drive systems—Part 3: EMC requirements and specific test methods
IEC/EN 61800-5-1	Adjustable speed electrical power drive systems—Part 5-1: Safety requirements—Electrical, thermal and energy
IEC/EN 61800-5-2	Adjustable speed electrical power drive systems—Part 5-2: Safety requirements—Function
GB/T 30844.1	General-purpose variable-frequency adjustable-speed equipment of 1 kV and lower—Part 1: Technical conditions
GB/T 30844.2	General-purpose variable-frequency adjustable-speed equipment of 1 kV and lower—Part 2: Test methods
GB/T 30844.3	General-purpose variable-frequency adjustable-speed equipment of 1 kV and lower—Part 3: Safety regulations

B.5.1 CE marking

The CE marking on the name plate of a VFD indicates that the VFD is CE-compliant, meeting the regulations of the European low-voltage directive (2014/35/EU) and EMC directive (2014/30/EU).

B.5.2 EMC compliance declaration

European union (EU) stipulates that the electric and electrical devices sold in Europe cannot generate electromagnetic disturbance that exceeds the limits stipulated in related standards, and can work properly in environments with certain electromagnetic interference. The EMC product standard (EN 61800-3) describes the EMC standards and specific test methods for adjustable speed electrical power drive systems. Our products have been compliant with these EMC regulations.

B.6 EMC regulations

The EMC product standard (EN 61800-3:2004) describes the EMC requirements on VFDs.

Application environment categories

Category I: Civilian environments, including application scenarios where VFDs are directly connected to the civil power supply low-voltage grids without intermediate transformers

Category II: All environments except those in Category I.

VFD categories

C1: Rated voltage lower than 1000 V, applied to environments of Category I.

C2: Rated voltage lower than 1000 V, non-plug, socket, or mobile devices; power drive systems that must be installed and operated by specialized personnel when applied to environments of Category I

Note: The EMC standard IEC/EN 61800-3 no longer restricts the power distribution of VFDs, but it specifies their use, installation, and commissioning. Specialized personnel or organizations must have the necessary skills (including the EMC-related knowledge) for installing and/or performing commissioning on the electrical drive systems.

C3: Rated voltage lower than 1000 V, applied to environments of Category II. They cannot be applied to environments of Category I.

C4: Rated voltage higher than 1000 V, or rated current higher or equal to 400 A, applied to complex systems in environments of Category II.

B.6.1 VFD category of C2

The induction disturbance limit meets the following stipulations:

1. Select an optional EMC filter according to Appendix D and install it following the description in the EMC filter manual.
2. Select the motor and control cables according to the description in the manual.
3. Install the VFD according to the description in the manual.
4. For the maximum length of the motor cable, see section B.4.1 EMC compatibility and motor cable length.



◇ Currently in environments in China, the VFD may generate radio interference, you need to take measures to reduce the interference.

B.6.2 VFD category of C3

The anti-interference performance of the VFD meets the requirements of environments Category II in the IEC/EN 61800-3 standard.

The induction disturbance limit meets the following stipulations:

1. Select an optional EMC filter according to Appendix D and install it following the description in the EMC filter manual.
2. Select the motor and control cables according to the description in the manual.
3. Install the VFD according to the description in the manual.
4. For the maximum length of the motor cable, see section B.4.1 EMC compatibility and motor cable length.



◇ VFDs of C3 category cannot be applied to civilian low-voltage common grids. When applied to such grids, the VFD may generate radio frequency electromagnetic interference.

Appendix C Dimension drawings

C.1 What this chapter contains

This chapter describes the dimension drawings of Goodrive350 IP54 high-ingress protection series VFDs. The dimension unit used in the drawings is mm.

C.2 VFD structure

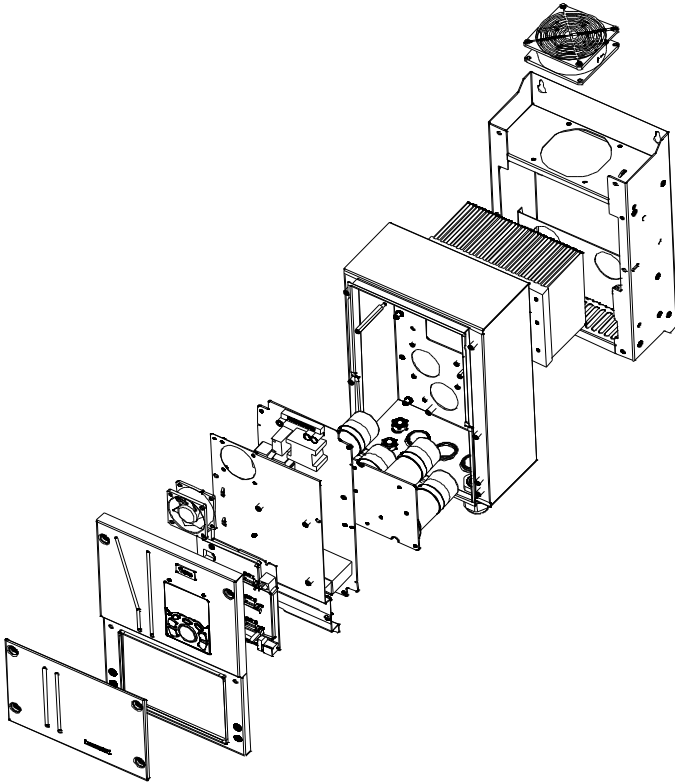

Figure C-1 VFD structure diagram

C.3 Dimensions of VFDs

C.3.1 Wall-mounting dimensions

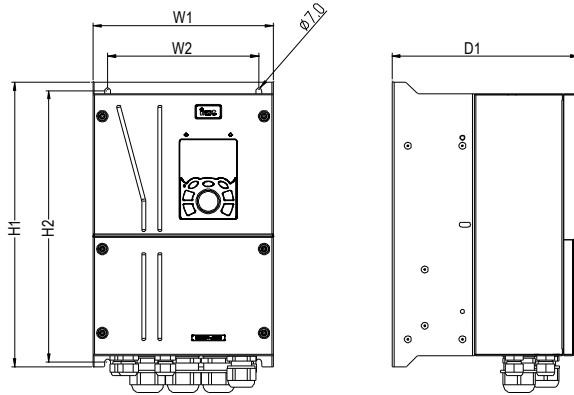

Figure C-2 Wall-mounting diagram of VFDs of 004G/5R5P-022G/030P

Table C-1 Wall-mounting dimensions of VFDs (unit: mm)

VFD model	W1	W2	H1	H2	D1	Installation hole diameter	Fixing screw	Net weight (kg)	Gross weight (kg)
004G/5R5P-5R5G/7R5P	196	164	296	282	212	6	M5	7	8.5
7R5G/011P-015G/018P	223	187	352	335.5	231	7	M6	10.6	12.5
018G/022P-022G/030P	274	234	399	380.5	231	7	M6	17.7	20.1

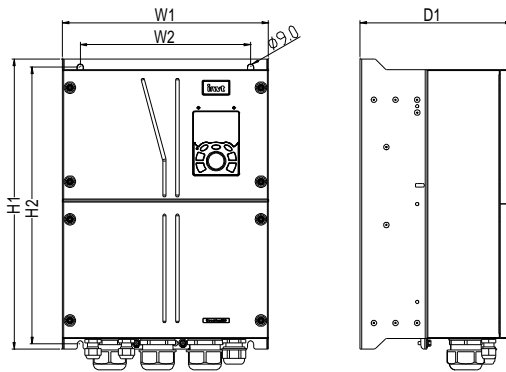

Figure C-3 Wall-mounting diagram of VFDs of 030G/037P-037G/045P

Table C-2 Wall-mounting dimensions of VFDs (unit: mm)

VFD model	W1	W2	H1	H2	D1	Installation hole diameter	Fixing screw	Net weight (kg)	Gross weight (kg)
030G/037P-037G/045P	318	263	447	426.5	235	9	M8	23.4	26.1

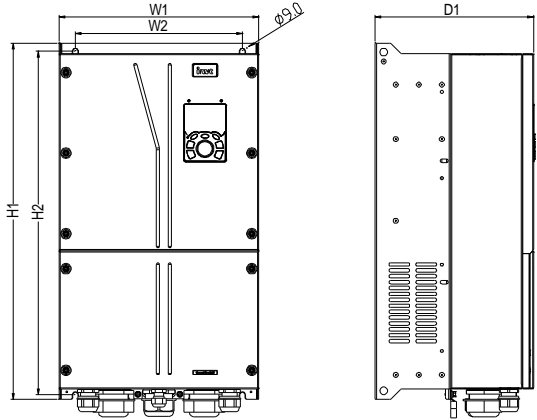

Figure C-4 Wall-mounting diagram of VFDs of 045G/055P-055G/075P

Table C-3 Wall-mounting dimensions of VFDs (unit: mm)

VFD model	W1	W2	H1	H2	D1	Installation hole diameter	Fixing screw	Net weight (kg)	Gross weight (kg)
045G/055P	338	283	610	588.5	269	9	M8	38	42
055G/075P	338	283	610	588.5	269	9	M8	41	44.8

C.3.2 Flange installation dimensions

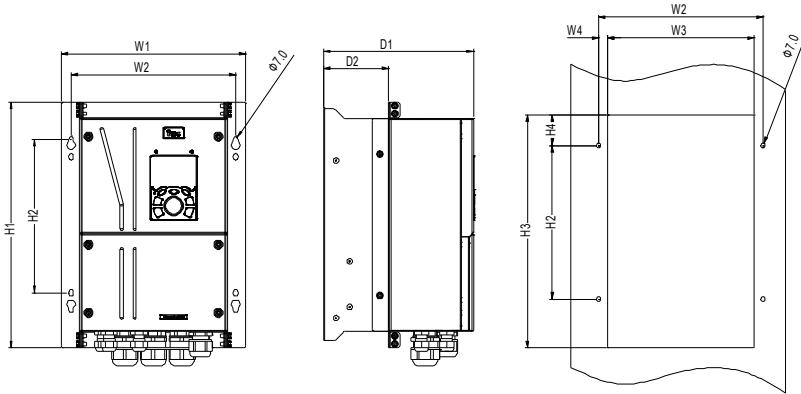

Figure C-5 Flange installation diagram of VFDs of 004G/5R5P-022G/030P

Table C-4 Flange installation dimensions of VFDs (unit: mm)

VFD model	W1	W2	W3	W4	H1	H2	H3	H4	D1	D2	Installation on hole diameter	Fixing screw	Net weight (kg)	Gross weight (kg)
004G/5R5P-5R5G/7R5P	256	232	212.6	9.7	328	213.5	298	29	212	78.5	6	M5	7	8.5
7R5G/011P-015G/018P	283	253	233.6	9.7	374	233.5	354	47	231	100.5	7	M6	10.6	12.5
018G/022P-022G/030P	334	310	290.6	9.7	433	273.5	401	50.5	231	100.5	7	M6	17.7	20.1

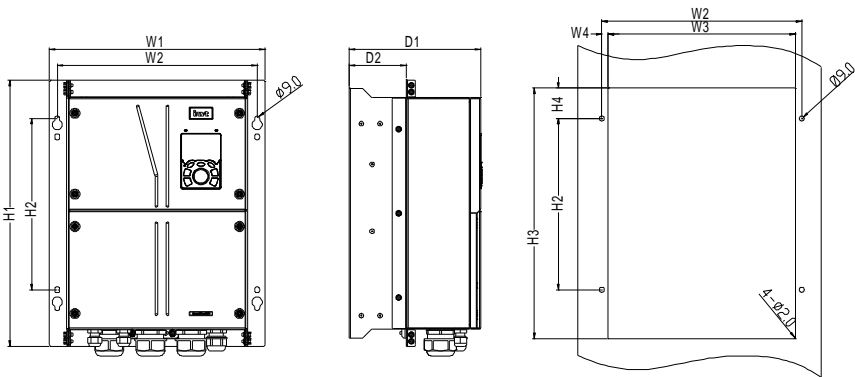

Figure C-6 Flange installation diagram of VFDs of 030G/037P-037G/045P

Table C-5 Flange installation dimensions of VFDs (unit: mm)

VFD model	W1	W2	W3	W4	H1	H2	H3	H4	D1	D2	Installati on hole diameter	Fixing screw	Net weight (kg)	Gross weight (kg)
030G/037P-037G/045P	386	358	335.6	11.2	477	307	449	54.5	212	78.5	9	M8	23.4	26.1

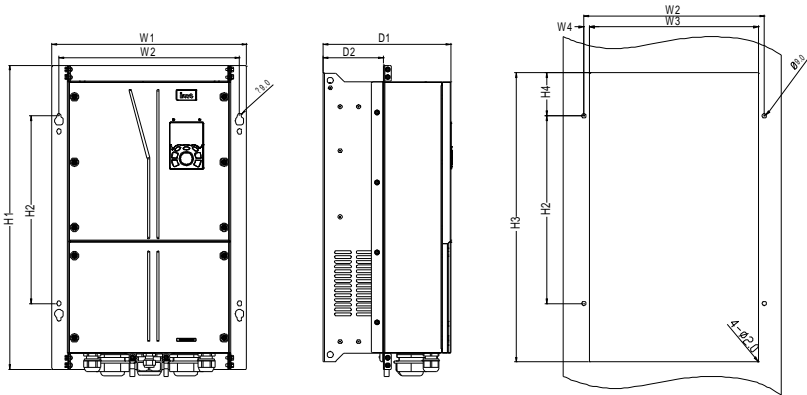

Figure C-7 Flange installation diagram of VFDs of 037G/045P-055G/075P

Table C-6 Flange installation dimensions of VFDs (unit: mm)

VFD model	W1	W2	W3	W4	H1	H2	H3	H4	D1	D2	Installati on hole diameter	Fixing screw	Net weight (kg)	Gross weight (kg)
045G/055P	410	380	335.6	12.2	644	397	612	91	269	126.5	9	M8	38	42
055G/075P	410	380	335.6	12.2	644	397	612	91	269	126.5	9	M8	41	44.8

Appendix D Optional peripheral accessories

D.1 What this chapter contains

This chapter describes how to select optional accessories of Goodrive350 IP54 high-ingress protection series VFDs.





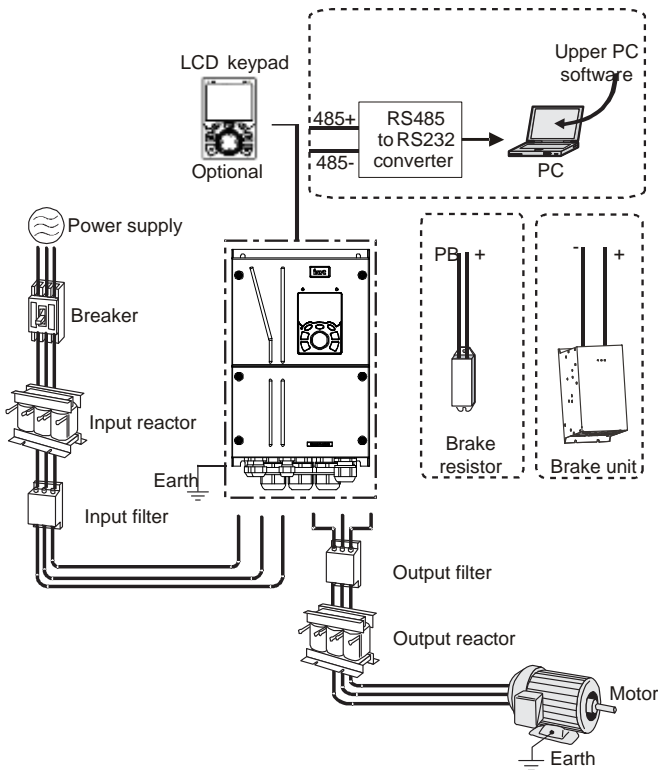

D.2 Wiring of peripheral accessories

The following figure shows the external wiring of a Goodrive350 IP54 high-ingress protection series VFD.

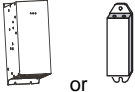

Note:

1. VFDs of 037G/045P or lower are equipped with built-in brake units, and VFDs of 045G/055P–110G/132P support optional built-in brake units
2. VFDs of 018G/022P to 110G/0132P are equipped with built-in DC reactors.
3. The brake units INVT's DBU series standard brake units. For details, see the DBU operation manual.

Image	Name	Description
	Cable	Accessory for signal transmission
	Breaker	Device for electric shock prevention and protection against short-to-ground that may cause current leakage and fire. Select residual-current circuit breakers (RCCBs) that are applicable to VFDs and can restrict high-order harmonics, and of which the rated sensitive current for one VFD is larger than 30 mA.
	Input reactor	Accessories used to improve the current adjustment coefficient on the input side of the VFD, and thus restrict high-order harmonic currents.
	Input filter	Accessory that restricts the electromagnetic interference generated by the VFD and transmitted to the public grid through the power cable. Try to install the input filter near the input terminal side of the VFD.
	Brake unit or brake resistor	Accessories used to consume the regenerative energy of the motor to reduce the deceleration time. VFDs of 037G/045P or lower only need to be configured with brake resistors, VFDs of 132G/160P or higher also need to be configured with brake units, and VFDs of 045G/055P–110G/132P support optional built-in brake units.
	Output filter	Accessory used to restrict interference generated in the wiring area on the output side of the VFD. Try to install the output filter near the output terminal side of the VFD.
	Output reactor	Accessory used to lengthen the valid transmission distance of the VFD, which effectively restrict the transient high voltage generated during the switch-on and switch-off of the IGBT module of the VFD.

D.3 Power supply

Refer to the electrical installation.

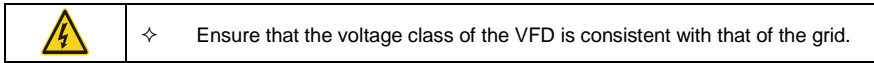

D.4 Cables

D.4.1 Power cables

The sizes of the input power cables and motor cables must meet the local regulation.

- The input power cables and motor cables must be able to carry the corresponding load currents.
- The maximum temperature margin of the motor cables in continuous operation cannot be lower than 70°C.
- The conductivity of the PE grounding conductor is the same as that of the phase conductor. For models higher than 30 kW, the cross sectional area of the PE grounding conductor can be slightly less than the recommended area.
- For details about the EMC requirements, see Appendix B "Technical data".

To meet the EMC requirements stipulated in the CE standards, you must use symmetrical shielded cables as motor cables (as shown in the following figure).

Four-core cables can be used as input cables, but symmetrical shielded cables are recommended. Compared with four-core cables, symmetrical shielded cables can reduce electromagnetic radiation as well as the current and loss of the motor cables.

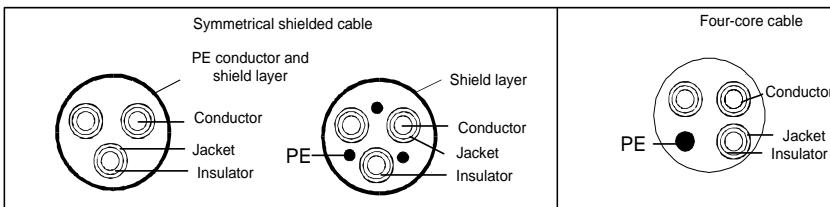

Note: If the conductivity of the shield layer of the motor cables cannot meet the requirements, separate PE conductors must be used.

To protect the conductors, the cross-sectional area of the shielded cables must be the same as that of the phase conductors if the cable and conductor are made of materials of the same type. This reduces grounding resistance, and thus improves impedance continuity.

To effectively restrict the emission and conduction of radio frequency (RF) interference, the conductivity of the shielded cable must at least be 1/10 of the conductivity of the phase conductor. This requirement can be well met by a copper or aluminium shield layer. The following figure shows the minimum requirement on motor cables of a VFD. The cable must consist of a layer of

spiral-shaped copper strips. The denser the shield layer is, the more effectively the electromagnetic interference is restricted.

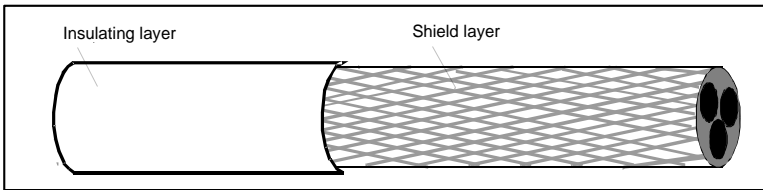

Figure D-1 Cross-section of the cable

D.4.2 Control cables

All analog control cables and cables used for frequency input must be shielded cables. Analog signal cables need to be double-shielded twisted-pair cables (as shown in figure a). Use one separate shielded twisted pair for each signal. Do not use the same ground wire for different analog signals.

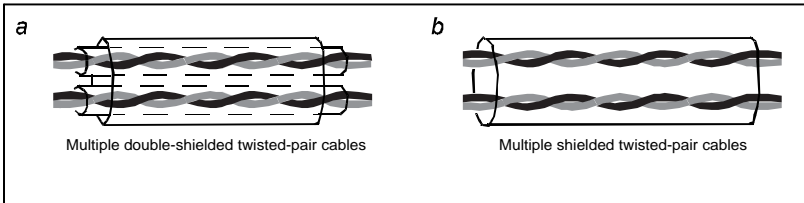

Figure D-2 Power cable arrangement

For low-voltage digital signals, double-shielded cables are recommended, but shielded or unshielded twisted pairs (as shown in figure b) also can be used. For frequency signals, however, only shielded cables can be used.

Relay cables need to be those with metal braided shield layers.

Keypads need to be connected by using network cables. In complicated electromagnetic environments, shielded network cables are recommended.

Note: Analog signals and digital signals cannot use the same cables, and their cables must be arranged separately.

Do not perform any voltage endurance or insulation resistance tests, such as high-voltage insulation tests or using a megameter to measure the insulation resistance, on the VFD or its components. Insulation and voltage endurance tests have been performed between the main circuit and chassis of each VFD before delivery. In addition, voltage limiting circuits that can automatically cut off the test voltage are configured inside the VFDs.

Note: Check the insulation conditions of the input power cable of a VFD according to the local regulations before connecting it.

Table D-1 Recommended cable dimensions

VFD model	Recommended cable size (mm ²)			Fixing screw	
	RST UVW	PE	PB (+) (-)	Terminal screw specificati on	Tightening torque (Nm)
GD350-004G/5R5P-45	1.5	1.5	1.5	M4	1.2–1.5
GD350-5R5G/7R5P-45	1.5	1.5	1.5	M5	2–2.5
GD350-7R5G/011P-45	2.5	2.5	2.5	M5	2–2.5
GD350-011G/015P-45	4	4	4	M5	2–2.5
GD350-015G/018P-45	6	6	6	M5	2–2.5
GD350-018G/022P-45	10	10	10	M6	4–6
GD350-022G/030P-45	10	10	10	M6	4–6
GD350-030G/037P-45	16	16	16	M8	9–11
GD350-037G/045P-45	25	16	25	M8	9–11
GD350-045G/055P-45	25	16	25	M8	9–11
GD350-055G/075P-45	35	16	35	M10	18–23

Note:

1. Cables of the sizes recommended for the main circuit can be used in scenarios where the ambient temperature is lower than 40°C, the wiring distance is shorter than 100 m, and the current is the rated current.
2. The terminals P1, (+), and (-) are used to connect to brake accessories.

D.4.3 Cable arrangement

Motor cables must be arranged away from other cables. The motor cables of several VFDs can be arranged in parallel. It is recommended that you arrange the motor cables, input power cables, and control cables separately in different trays. The output dU/dt of the VFDs may increase electromagnetic interference on other cables. Do not arrange other cables and the motor cables in parallel.

If a control cable and power cable must cross each other, ensure that the angle between them is 90 degrees.

The cable trays must be connected properly and well grounded. Aluminum trays can implement local equipotential.

The following figure shows the cable arrangement distance requirements.

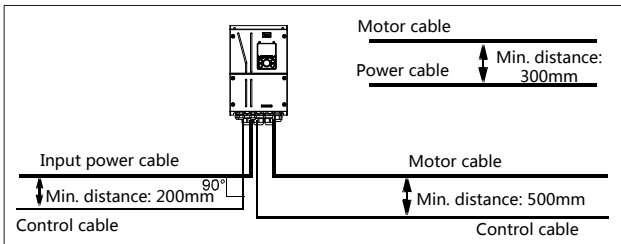

Figure D-3 Cable arrangement distance

D.4.4 Insulation inspection

Check the motor and the insulation conditions of the motor cable before running the motor.

1. Ensure that the motor cable is connected to the motor, and then remove the motor cable from the U, V, and W output terminals of the VFD.
2. Use a megameter of 500 V DC to measure the insulation resistance between each phase conductor and the protection grounding conductor. For details about the insulation resistance of the motor, see the description provided by the manufacturer.

Note: The insulation resistance is reduced if it is damp inside the motor. If it may be damp, you need to dry the motor and then measure the insulation resistance again.

D.5 Breaker and electromagnetic contactor

You need to add a fuse to prevent overload.

You need to configure a manually manipulated molded case circuit breaker (MCCB) between the AC power supply and VFD. The breaker must be locked in the open state to facilitate installation and inspection. The capacity of the breaker needs to be 1.5 to 2 times the VFD rated input current.

	<p>◇ According to the working principle and structure of breakers, if the manufacturer's regulation is not followed, hot ionized gases may escape from the breaker enclosure when short-circuit occurs. To ensure safe use, exercise extra caution when installing and placing the breaker. Follow the manufacturer's instructions.</p>
---	---

To ensure safety, you can configure an electromagnetic contactor on the input side to control the switch-on and switch-off of the main circuit power, so that the input power supply of the VFD can be effectively cut off when a system fault occurs.

Table D-2 Parameters of the optional accessories

VFD model	Breaker rated current (A)	Fast-acting fuse rated current (A)	Contactor rated current (A)
GD350-004G/5R5P-45	20	20	18
GD350-5R5G/7R5P-45	25	35	25

VFD model	Breaker rated current (A)	Fast-acting fuse rated current (A)	Contactora rated current (A)
GD350-7R5G/011P-45	32	40	32
GD350-011G/015P-45	50	50	38
GD350-015G/018P-45	63	60	50
GD350-018G/022P-45	63	70	65
GD350-022G/030P-45	80	90	80
GD350-030G/037P-45	100	125	80
GD350-037G/045P-45	125	125	98
GD350-045G/055P-45	140	150	115
GD350-055G/075P-45	180	200	150

Note: Parameters of the optional accessories described in the preceding table are ideal values. You can select accessories based on the actual market conditions, but try not to use those with lower values.

D.6 Reactors

When the voltage of the grid is high, the transient large current that flows into the input power circuit may damage rectifier components. You need to configure an AC reactor on the input side, which can also improve the current adjustment coefficient on the input side.

When the distance between the VFD and motor is longer than 50 m, the parasitic capacitance between the long cable and ground may cause large leakage current, and overcurrent protection of the VFD may be frequently triggered. To prevent this from happening and avoid damage to the motor insulator, compensation must be made by adding an output reactor. When a VFD is used to drive multiple motors, take the total length of the motor cables (that is, sum of the lengths of the motor cables) into account. When the total length is longer than 50 m, an output reactor must be added on the output side of the VFD. If the distance between the VFD and motor is 50 m to 100 m, select the reactor according to the following table. If the distance is longer than 100 m, contact INVT's technical support technicians.

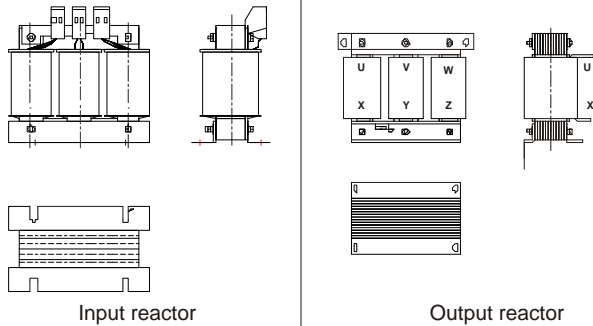

Table D-3 Models of reactors

VFD model	Input reactor	Output reactor
GD350-004G/5R5P-45	ACL2-004-4	OCL2-004-4
GD350-5R5G/7R5P-45	ACL2-5R5-4	OCL2-5R5-4
GD350-7R5G/011P-45	ACL2-7R5-4	OCL2-7R5-4
GD350-011G/015P-45	ACL2-011-4	OCL2-011-4
GD350-015G/018P-45	ACL2-015-4	OCL2-015-4
GD350-018G/022P-45	ACL2-018-4	OCL2-018-4
GD350-022G/030P-45	ACL2-022-4	OCL2-022-4
GD350-030G/037P-45	ACL2-037-4	OCL2-037-4
GD350-037G/045P-45	ACL2-037-4	OCL2-037-4
GD350-045G/055P-45	ACL2-045-4	OCL2-045-4
GD350-055G/075P-45	ACL2-055-4	OCL2-055-4

Note:

1. The rated input voltage drop of input reactors is 2%±15%.
2. The rated output voltage drop of output reactors is 1%±15%.
3. The preceding table describes external accessories. You need to specify the ones you choose when purchasing accessories.

D.7 Filters

J10 is not connected in factory for VFDs of 022G/030P and below. Connect the J10 packaged with the manual if the requirements of level C3 need to be met;

Note:

Disconnect J10 in the following situations:

1. The EMC filter is applicable to the neutral-grounded grid system. If it is used for the IT grid system (that is, non-neutral grounded grid system), disconnect J10.

- If leakage protection occurs during configuration of a residual-current circuit breaker, disconnect J10.

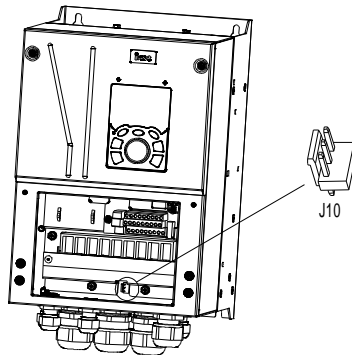

Note: Do not connect C3 filters in IT power systems.

Interference filters on the input side can reduce the interference of VFDs (when used) on the surrounding devices.

Noise filters on the output side can decrease the radio noise caused by the cables between VFDs and motors and the leakage current of conducting wires.

INVT provides some of the filters for users to choose.

D.7.1 Filter model description



Figure D-4 Filter models

Table D-4 Model description

Field identifier	Field description
A	FLT: Name of the VFD filter series
B	Filter type P: Power input filter L: Output filter
C	Voltage class 04: AC 3PH 380V (-15%)–440V (+10%)
D	3-digit code indicating the rated current. For example, 015 indicates 15 A.
E	Filter performance L: General H: High-performance

Field identifier	Field description
F	Filter application environment A: Environment Category I (IEC61800-3), C1 (EN 61800-3) B: Environment Category I (IEC61800-3), C2 (EN 61800-3) C: Environment Category II (IEC61800-3), C3 (EN 61800-3)

Table D-5 Models of filters

VFD model	Input filter	Output filter
GD350-004G/5R5P-45	FLT-P04016L-B	FLT-L04016L-B
GD350-5R5G/7R5P-45		
GD350-7R5G/011P-45	FLT-P04032L-B	FLT-L04032L-B
GD350-011G/015P-45		
GD350-015G/018P-45	FLT-P04045L-B	FLT-L04045L-B
GD350-018G/022P-45		
GD350-022G/030P-45	FLT-P04065L-B	FLT-L04065L-B
GD350-030G/037P-45		
GD350-037G/045P-45	FLT-P04100L-B	FLT-L04100L-B
GD350-045G/055P-45		
GD350-055G/075P-45	FLT-P04150L-B	FLT-L04150L-B

Note:

1. The input EMI meets the C2 requirements after an input filter is configured.
2. The preceding table describes external accessories. You need to specify the ones you choose when purchasing accessories.

D.8 Brake system

D.8.1 Brake component selection

When a VFD driving a high-inertia load decelerates or needs to decelerate abruptly, the motor runs in the power generation state and transmits the load-carrying energy to the DC circuit of the VFD, causing the bus voltage of the VFD to rise. If the bus voltage exceeds a specific value, the VFD reports an overvoltage fault. To prevent this from happening, you need to configure brake components.

	<ul style="list-style-type: none"> ✧ The design, installation, commissioning, and operation of the device must be performed by trained and qualified professionals. ✧ Follow all the "Warning" instructions during the operation. Otherwise, major physical injuries or property loss may be caused. ✧ Only qualified electricians are allowed to perform the wiring. Otherwise, damage to the VFD or brake components may be caused. ✧ Read the brake resistor or unit instructions carefully before connecting them to the VFD.
---	---

	<p>✧ Connect brake resistors only to the terminals PB and (+), and brake units only to the terminals (+) and (-). Do not connect them to other terminals. Otherwise, damage to the brake circuit and VFD and fire may be caused.</p>
	<p>✧ Connect the brake components to the VFD according to the wiring diagram. If the wiring is not properly performed, damage to the VFD or other devices may be caused.</p>



Goodrive350 IP54 high-ingress protection series VFDs of 037G/045P or lower are equipped with built-in brake units, Select brake resistors according to the specific requirements (such as the brake torque and brake usage requirements) on site.

Table D-6 Brake unit signals

VFD model	Brake unit model	Resistance applicable for 100% brake torque (Ω)	Dissipated power of brake resistor (kW)	Dissipated power of brake resistor (kW)	Dissipated power of brake resistor (kW)	Min. allowable brake resistance (Ω)
			10% brake usage	50% brake usage	80% brake usage	
GD350-004G/5R5P-45	Built-in brake unit	122	0.6	3	4.8	80
GD350-5R5G/7R5P-45		89	0.75	4.1	6.6	60
GD350-7R5G/011P-45		65	1.1	5.6	9	47
GD350-011G/015P-45		44	1.7	8.3	13.2	31
GD350-015G/018P-45		32	2	11	18	23
GD350-018G/022P-45		27	3	14	22	19
GD350-022G/030P-45		22	3	17	26	17
GD350-030G/037P-45		17	5	23	36	17
GD350-037G/045P-45		13	6	28	44	11.7
GD350-045G/055P-45-B	DBU100H	10	7	34	54	6.4
GD350-055G/075P-45-B	-110-4	8	8	41	66	

Note:

1. Select brake resistors according to the resistance and power data provided by our company.
2. The brake resistor may increase the brake torque of the VFD. The preceding table describes the resistance and power for 100% brake torque, 10% brake usage, 50% brake usage, and 80% brake usage. You can select the brake system based on the actual operation conditions.
3. When using an external brake unit, set the brake voltage class of the brake unit properly by referring to the manual of the dynamic brake unit. If the voltage class is set incorrectly, the VFD may not run properly.

	<p>⋄ Do not use brake resistors whose resistance is lower than the specified minimum resistance. VFDs do not provide protection against overcurrent caused by resistors with low resistance.</p>
	<p>⋄ In scenarios where brake is frequently implemented, that is, the brake usage is greater than 10%, you need to select a brake resistor with higher power as required by the operation conditions according to the preceding table.</p>

D.8.2 Brake resistor cable selection

Brake resistor cables need to be shielded cables.

D.8.3 Brake resistor installation

All resistors need to be installed in places with good cooling conditions.

	<p>⋄ The materials near the brake resistor or brake unit must be non-flammable. The surface temperature of the resistor is high. Air flowing from the resistor is of hundreds of degrees Celsius. Prevent any materials from coming into contact with the resistor.</p>
---	---

Installation of brake resistors

	<p>⋄ VFDs of 037G/045P or lower need only built-in brake resistors.</p> <p>⋄ PB and (+) are the terminals for connecting brake resistors.</p>
---	---

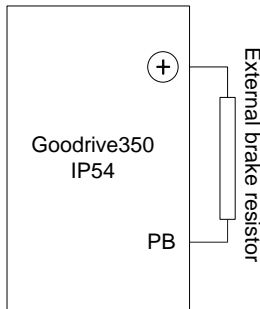

Installation of brake units

	<p>⋄ (+) and (-) are the terminals for connecting brake units.</p> <p>⋄ The connection cables between the (+) and (-) terminals of a VFD and those of a brake unit must be shorter than 5 m, and the connection cables between the BR1 and BR2 terminals of a brake unit and the terminals of a brake resistor must be shorter than 10 m.</p>
---	---

The following figure shows the connection of one VFD to a dynamic brake unit.

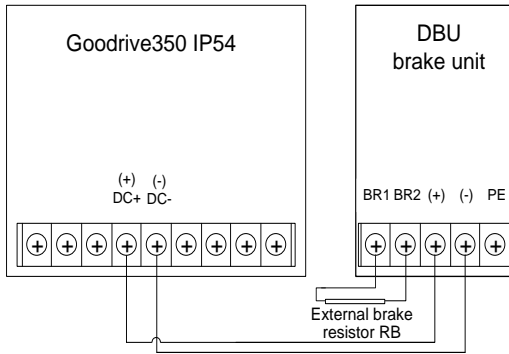

Appendix E STO function description

Reference standards: IEC 61508-1, IEC 61508-2, IEC 61508-3, IEC 61508-4, IEC 62061, ISO 13849-1, and IEC 61800-5-2

You can enable the safe torque off (STO) function to prevent unexpected startups when the main power supply of the drive is not switched off. The STO function switches off the drive output by turning off the drive signals to prevent unexpected startups of the motor (see the following figure). After the STO function is enabled, you can perform some-time operations (such as non-electrical cleaning in the lathe industry) and maintain the non-electrical components of the device without switching off the drive.

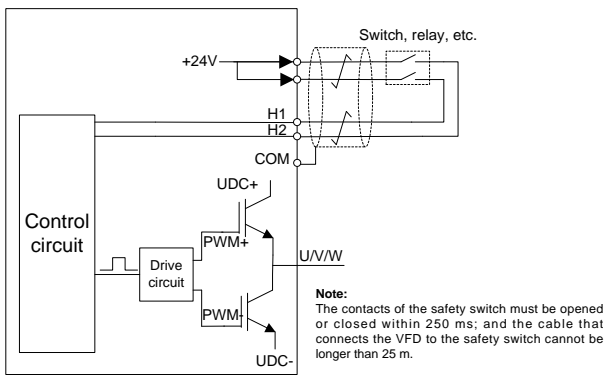

E.1 STO function logic table

The following table describes the input states and corresponding faults of the STO function.

STO input state	Corresponding fault
H1 and H2 opened simultaneously	The STO function is triggered, and the drive stops running. Fault code: 40: Safe torque off (STO)
H1 and H2 closed simultaneously	The STOP function is not triggered, and the drive runs properly.
One of H and H2 opened, and the other closed	The STL1, STL2, or STL3 fault occurs. Fault code: 41: Channel H1 exception (STL1) 42: Channel H2 exception (STL2) 43: Channel H1 and H2 exceptions (STL3)

E.2 STO channel delay description

The following table describes the trigger and indication delay of the STO channels.

STO mode	STO trigger and indication delay ^{1, 2}
STO fault: STL1	Trigger delay < 10 ms Indication delay < 280 ms
STO fault: STL2	Trigger delay < 10 ms Indication delay < 280 ms
STO fault: STL3	Trigger delay < 10 ms Indication delay < 280 ms
STO fault: STO	Trigger delay < 10 ms Indication delay < 100 ms

1. STO function trigger delay: Time interval between trigger the STO function and switching off the drive output
2. STO instruction delay: Time interval between trigger the STO function and STO output state indication

E.3 STO function installation checklist

Before installing the STO, check the items described in the following table to ensure that the STO function can be properly used.

	Item
<input type="checkbox"/>	Ensure that the drive can be run or stopped randomly during commissioning.
<input type="checkbox"/>	Stop the drive (if it is running), disconnect the input power supply, and isolate the drive from the power cable through the switch.
<input type="checkbox"/>	Check the STO circuit connection according to the circuit diagram.
<input type="checkbox"/>	Check whether the shielding layer of the STO input cable is connected to the +24 V reference ground COM.
<input type="checkbox"/>	Connect the power supply.
<input type="checkbox"/>	Test the STO function as follows after the motor stops running: <ul style="list-style-type: none"> ● If the drive is running, send a stop command to it and wait until the shaft of the motor stops rotating. ● Activate the STO circuit and send a start command to the drive. Ensure that the motor does not start. ● Deactivate the STO circuit.
<input type="checkbox"/>	Restart the drive, and check whether the motor is running properly.
<input type="checkbox"/>	Test the STO function as follows when the motor is running: <ul style="list-style-type: none"> ● Start the drive. Ensure that the motor is running properly. ● Activate the STO circuit. ● The drive reports an STO fault (for details, see section 5.5.19 "Fault handling"). Ensure that the motor coasts to stop rotating. ● Deactivate the STO circuit.
<input type="checkbox"/>	Restart the drive, and check whether the motor is running properly.

Appendix F Further information

F.1 Product and service queries

Should you have any queries about the product, contact the local INVT office. Provide the model and serial number of the product you query about. You can visit www.invt.com to find a list of INVT offices.

F.2 Feedback on INVT VFD manuals

Your comments on our manuals are welcome. Visit www.invt.com, directly contact online service personnel or choose **Contact Us** to obtain contact information.

F.3 Documents on the Internet

You can find manuals and other product documents in the PDF format on the Internet. Visit www.invt.com and choose **Support > Download**.



Service line:86-755-86312859 E-mail:overseas@invt.com.cn Website:www.invt.com

The products are owned by **Shenzhen INVT Electric Co.,Ltd.**

Two companies are commissioned to manufacture: (For product code, refer to the 2nd/3rd place of S/N on the name plate.)

Shenzhen INVT Electric Co., Ltd. (origin code: 01)

Address: INVT Guangming Technology Building, Songbai Road,
Matian, Guangming District, Shenzhen, China

INVT Power Electronics (Suzhou) Co., Ltd. (origin code: 06)

Address: 1# Kunlun Mountain Road, Science&Technology Town,
Gaixin District, Suzhou, Jiangsu, China

- Industrial Automation:** ■ HMI ■ PLC ■ VFD ■ Servo System
 ■ Elevator Intelligent Control System ■ Rail Transit Traction System
- Energy & Power:** ■ UPS ■ DCIM ■ Solar Inverter ■ SVG
 ■ New Energy Vehicle Powerstain System ■ New Energy Vehicle Charging System
 ■ New Energy Vehicle Motor



Copyright© INVT.

Manual information may be subject to change without prior notice.

202011 (V1.3)